

**ENGINE SECTION 1**

This service manual has been prepared to provide SUBARU service personnel with the necessary information and data for the correct maintenance and repair of SUBARU vehicles.

This manual includes the procedures for maintenance, disassembling, reassembling, inspection and adjustment of components and diagnostics for guidance of experienced mechanics.

Please peruse and utilize this manual fully to ensure complete repair work for satisfying our customers by keeping their vehicle in optimum condition. When replacement of parts during repair work is needed, be sure to use SUBARU genuine parts.

All information, illustration and specifications contained in this manual are based on the latest product information available at the time of publication approval.

<b>FUEL INJECTION (FUEL SYSTEMS)</b>	<b>FU(H4SO 2.0)</b>
<b>EMISSION CONTROL (AUX. EMISSION CONTROL DEVICES)</b>	<b>EC(H4SO 2.0)</b>
<b>INTAKE (INDUCTION)</b>	<b>IN(H4SO 2.0)</b>
<b>MECHANICAL</b>	<b>ME(H4SO 2.0)</b>
<b>EXHAUST</b>	<b>EX(H4SO 2.0)</b>
<b>COOLING</b>	<b>CO(H4SO 2.0)</b>
<b>LUBRICATION</b>	<b>LU(H4SO 2.0)</b>
<b>SPEED CONTROL SYSTEMS</b>	<b>SP(H4SO 2.0)</b>
<b>IGNITION</b>	<b>IG(H4SO 2.0)</b>
<b>STARTING/CHARGING SYSTEMS</b>	<b>SC(H4SO 2.0)</b>
<b>ENGINE (DIAGNOSTICS)</b>	<b>EN(H4SO 2.0) (diag)</b>
<b>FUEL INJECTION (FUEL SYSTEMS)</b>	<b>FU(H4SO 2.5)</b>
<b>EMISSION CONTROL (AUX. EMISSION CONTROL DEVICES)</b>	<b>EC(H4SO 2.5)</b>
<b>INTAKE (INDUCTION)</b>	<b>IN(H4SO 2.5)</b>
<b>MECHANICAL</b>	<b>ME(H4SO 2.5)</b>
<b>EXHAUST</b>	<b>EX(H4SO 2.5)</b>
<b>COOLING</b>	<b>CO(H4SO 2.5)</b>

ENGINE SECTION 1

LUBRICATION

LU(H4SO 2.5)

SPEED CONTROL SYSTEMS

SP(H4SO 2.5)

IGNITION

IG(H4SO 2.5)

STARTING/CHARGING SYSTEMS

SC(H4SO 2.5)

ENGINE (DIAGNOSTICS)

EN(H4SO 2.5)  
(diag)

# EXHAUST

# *EX(H4SO 2.0)*

---

	Page
1. General Description .....	2
2. Front Exhaust Pipe.....	7
3. Center Exhaust Pipe .....	10
4. Rear Exhaust Pipe .....	11
5. Muffler .....	13

# General Description

EXHAUST

## 1. General Description

### A: COMPONENT

- 2.0 L model

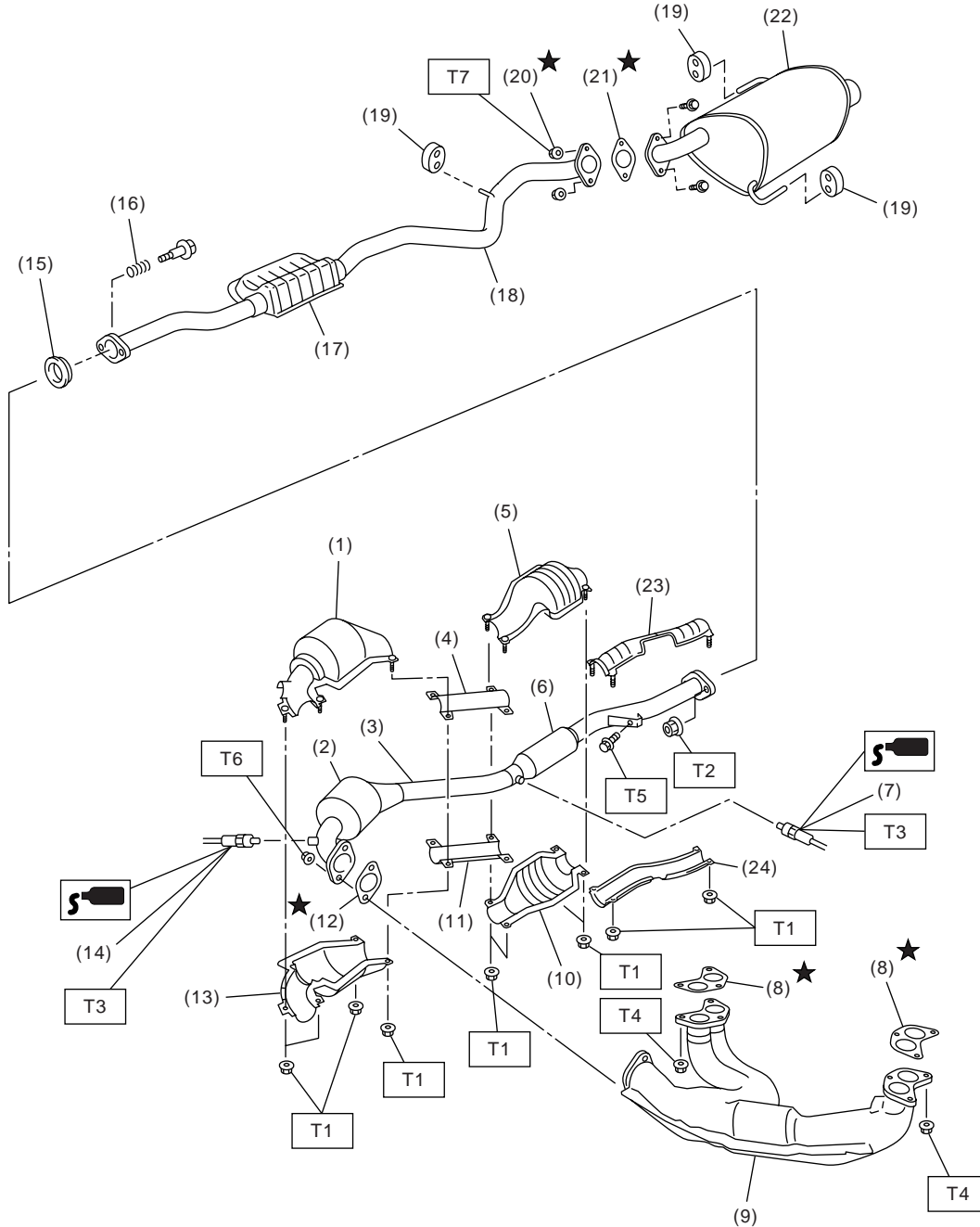

EX-02020

# General Description

EXHAUST

---

(1) Front catalytic converter upper cover	(11) Center exhaust pipe lower cover	(23) Rear exhaust pipe upper cover
(2) Front catalytic converter	(12) Gasket	(24) Rear exhaust pipe lower cover
(3) Center exhaust pipe	(13) Front catalytic converter lower cover	
(4) Center exhaust pipe upper cover	(14) Front oxygen (A/F) sensor	<b><i>Tightening torque: N·m (kgf-m, ft-lb)</i></b>
(5) Rear catalytic converter upper cover	(15) Gasket	<b><i>T1: 13 (1.3, 9.4)</i></b>
(6) Rear catalytic converter	(16) Spring	<b><i>T2: 18 (1.8, 13.0)</i></b>
(7) Rear oxygen sensor	(17) Chamber	<b><i>T3: 21 (2.1, 15.2)</i></b>
(8) Gasket	(18) Rear exhaust pipe	<b><i>T4: 30 (3.1, 22.4)</i></b>
(9) Front exhaust pipe	(19) Cushion rubber	<b><i>T5: 35 (3.6, 26.0)</i></b>
(10) Rear catalytic converter lower cover	(20) Self-locking nut	<b><i>T6: 40.8 (4.2, 30.1)</i></b>
	(21) Gasket	<b><i>T7: 48 (4.9, 35.4)</i></b>
	(22) Muffler	

---

# General Description

## EXHAUST

- 2.5 L model

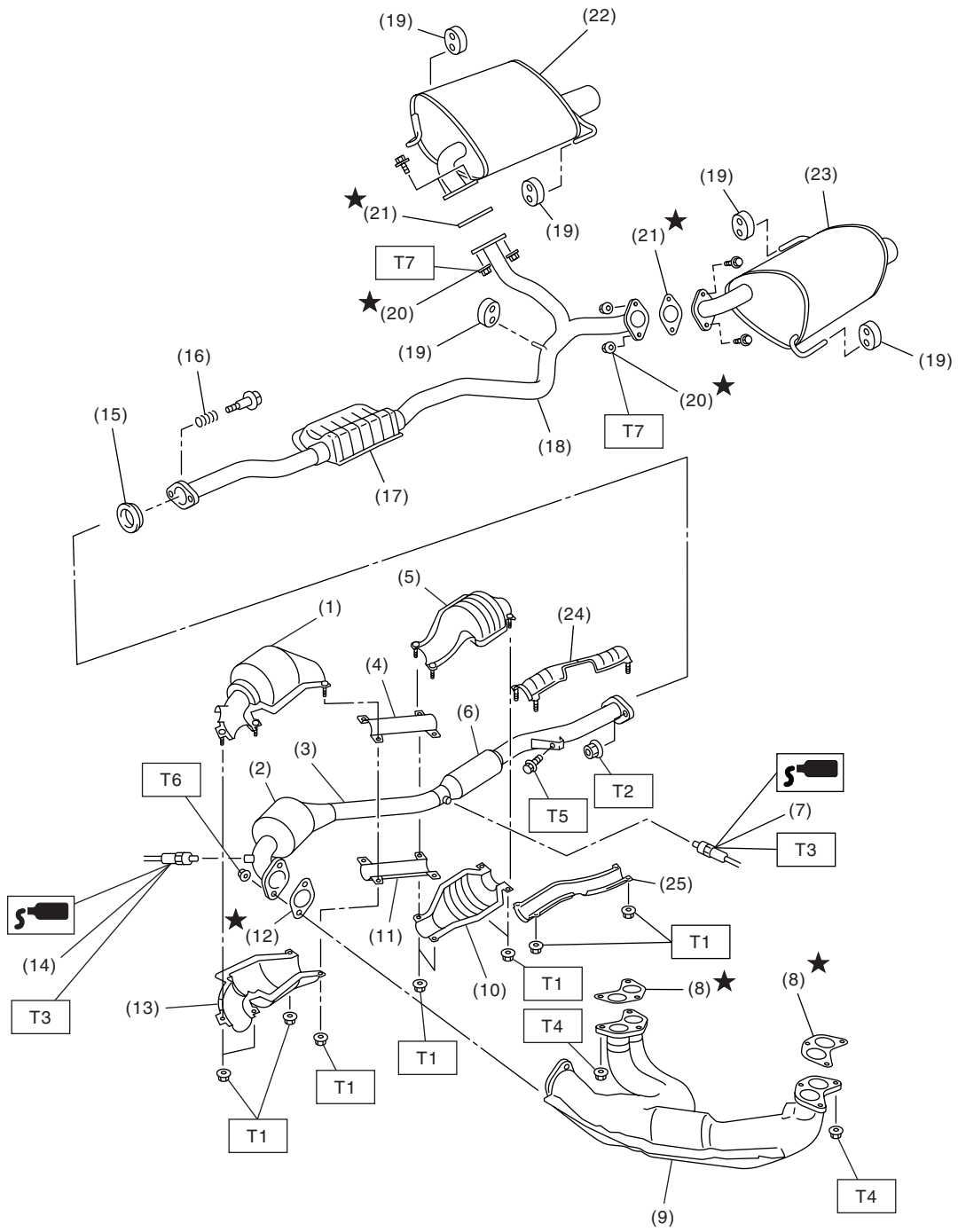

EX-02012

# General Description

EXHAUST

---

(1) Front catalytic converter upper cover	(11) Center exhaust pipe lower cover	(23) Muffler (LH)
(2) Front catalytic converter	(12) Gasket	(24) Rear exhaust pipe upper cover
(3) Center exhaust pipe	(13) Front catalytic converter lower cover	(25) Rear exhaust pipe lower cover
(4) Center exhaust pipe upper cover	(14) Front oxygen (A/F) sensor	<hr/> <b>Tightening torque: N·m (kgf-m, ft-lb)</b>
(5) Rear catalytic converter upper cover	(15) Gasket	<b>T1: 13 (1.3, 9.4)</b>
(6) Rear catalytic converter	(16) Spring	<b>T2: 18 (1.8, 13.0)</b>
(7) Rear oxygen sensor	(17) Chamber	<b>T3: 21 (2.1, 15.2)</b>
(8) Gasket	(18) Rear exhaust pipe	<b>T4: 30 (3.1, 22.4)</b>
(9) Front exhaust pipe	(19) Cushion rubber	<b>T5: 35 (3.6, 26.0)</b>
(10) Rear catalytic converter lower cover	(20) Self-locking nut	<b>T6: 40.8 (4.2, 30.1)</b>
	(21) Gasket	<b>T7: 48 (4.9, 35.4)</b>
	(22) Muffler (RH)	<hr/>

#### **B: CAUTION**

- Wear work clothing, including a cap, protective goggles and protective shoes during operation.
- Remove contamination including dirt and corrosion before removal, installation or disassembly.
- Keep the disassembled parts in order and protect them from dust and dirt.
- Before removal, installation or disassembly, be sure to clarify the failure. Avoid unnecessary removal, installation, disassembly and replacement.
- Be careful not to burn yourself, because each part on the vehicle is hot after running.
- Be sure to tighten fasteners including bolts and nuts to the specified torque.
- Place shop jacks or rigid racks at the specified points.
- Before disconnecting electrical connectors of sensors or units, be sure to disconnect the ground cable from battery.



## 2. Front Exhaust Pipe

### A: REMOVAL

1) Disconnect the ground cable from battery.

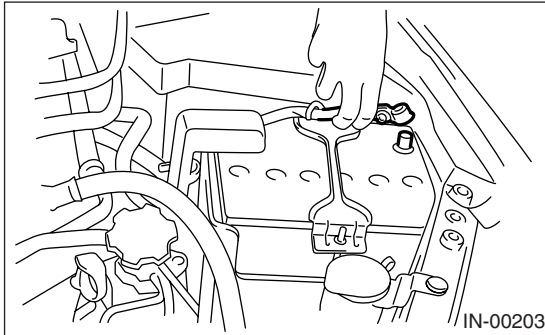

2) Disconnect the front oxygen (A/F) sensor connector.

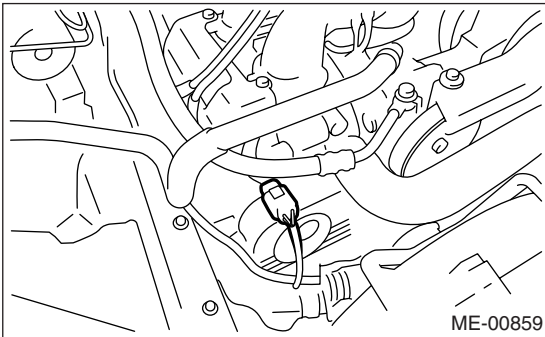

3) Lift-up the vehicle.

4) Disconnect the rear oxygen sensor connector.

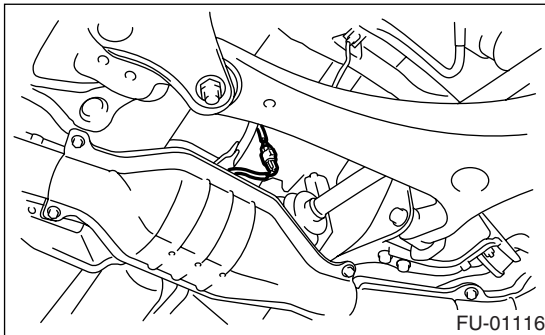

5) Separate the center exhaust pipe from rear exhaust pipe.

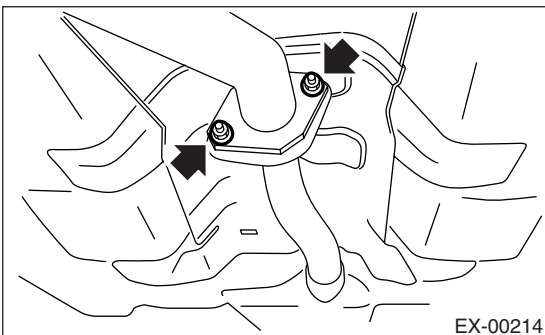

6) Remove the under cover.

7) Remove the nuts which hold front exhaust pipe onto cylinder heads.

### CAUTION:

**Be careful not to pull down the front and center exhaust pipe assembly.**

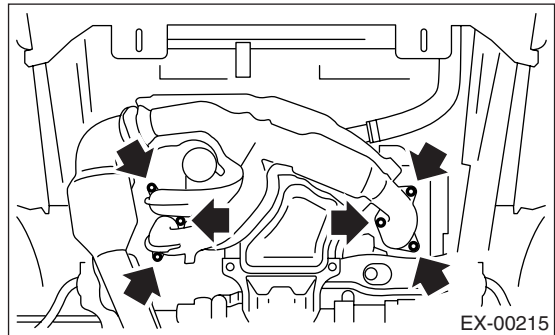

8) Remove the bolt which holds center exhaust pipe to hanger bracket.

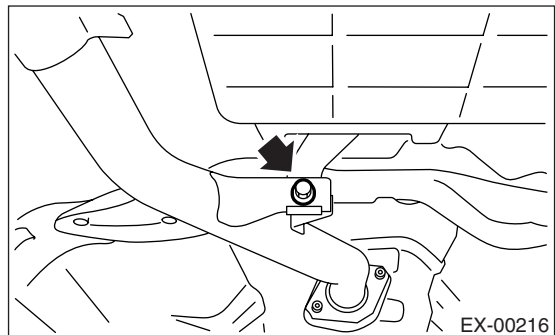

9) Remove the front and center exhaust pipe assembly from the vehicle.

### CAUTION:

• **Be careful not to let the front and center exhaust pipe assembly fall off when removing as it is quite heavy.**

• **After removing the front and center exhaust pipe assembly, do not apply excessive pulling force on the rear exhaust pipe.**

10) Separate the front exhaust pipe from center exhaust pipe.

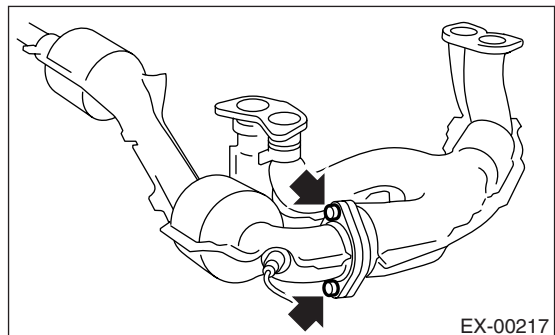

# Front Exhaust Pipe

## EXHAUST

11) Remove the front oxygen (A/F) sensor and rear oxygen sensor. <Ref. to FU(H4SO 2.0)-32, REMOVAL, Front Oxygen (A/F) Sensor.> <Ref. to FU(H4SO 2.0)-33, REMOVAL, Rear Oxygen Sensor.> or <Ref. to FU(H4SO 2.5)-34, REMOVAL, Front Oxygen (A/F) Sensor.> <Ref. to FU(H4SO 2.5)-35, REMOVAL, Rear Oxygen Sensor.>

### B: INSTALLATION

1) Install the front oxygen (A/F) sensor and rear oxygen sensor. <Ref. to FU(H4SO 2.0)-32, INSTALLATION, Front Oxygen (A/F) Sensor.> <Ref. to FU(H4SO 2.0)-33, INSTALLATION, Rear Oxygen Sensor.> or <Ref. to FU(H4SO 2.5)-34, INSTALLATION, Front Oxygen (A/F) Sensor.> <Ref. to FU(H4SO 2.5)-35, INSTALLATION, Rear Oxygen Sensor.>

2) Install the front exhaust pipe to center exhaust pipe.

#### NOTE:

Use a new gasket.

#### Tightening torque:

**40.8 N·m (4.2 kgf-m, 30.1 ft-lb)**

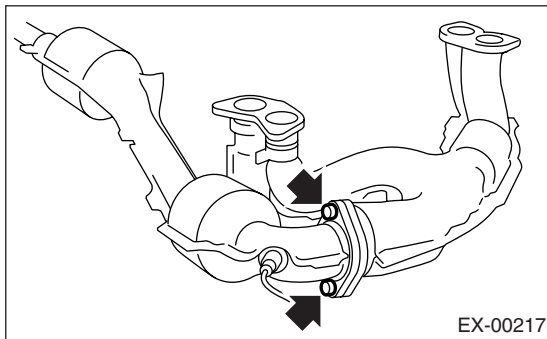

3) Install the front and center exhaust pipe assembly to the vehicle.

4) Temporarily tighten the bolt which holds the center exhaust pipe to hanger bracket.

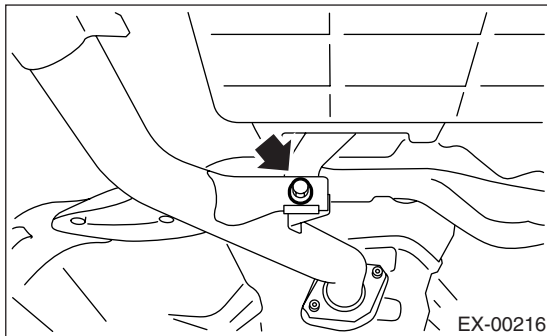

5) Install the nuts to cylinder head which hold front exhaust pipe.

#### Tightening torque:

**30 N·m (3.1 kgf-m, 22.4 ft-lb)**

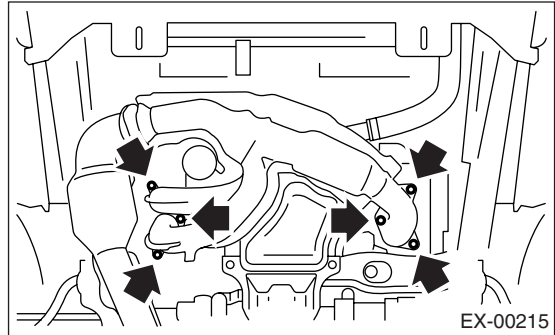

6) Install the under cover.

7) Tighten the bolts which install the center exhaust pipe to rear exhaust pipe.

#### Tightening torque:

**18 N·m (1.8 kgf-m, 13.0 ft-lb)**

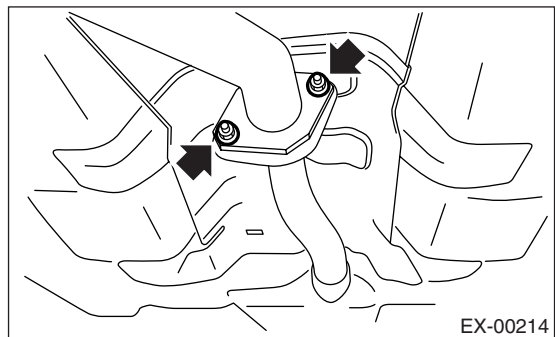

8) Tighten the bolt which holds the center exhaust pipe to hanger bracket.

#### Tightening torque:

**35 N·m (3.6 kgf-m, 26.0 ft-lb)**

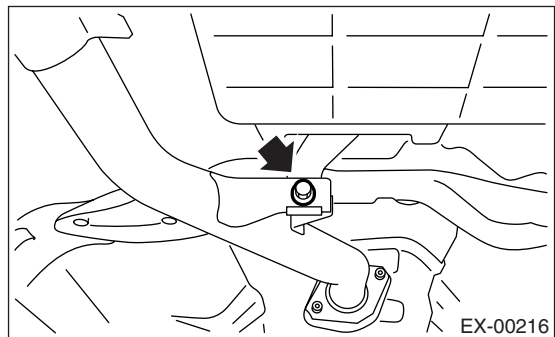

9) Connect the rear oxygen sensor connector.

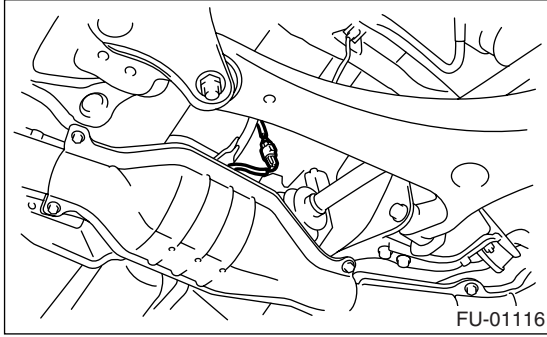

10) Lower the vehicle.

11) Connect the front oxygen (A/F) sensor connector.

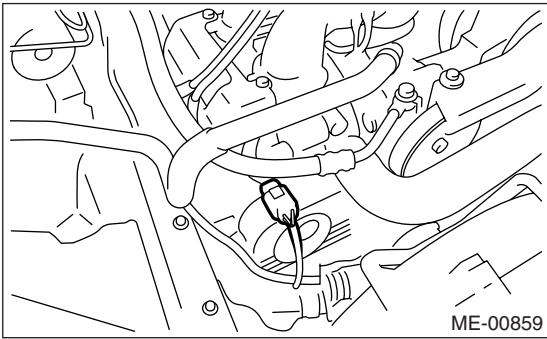

12) Connect the battery ground cable to battery.

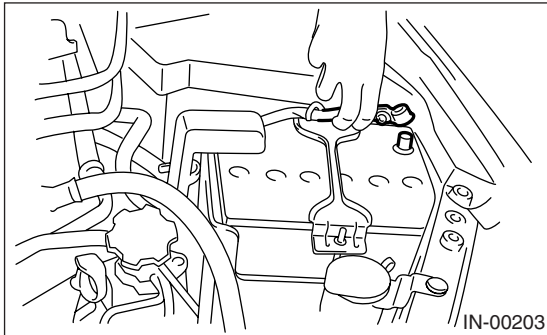

## C: INSPECTION

- 1) Make sure there are no exhaust leaks from connections and welds.
- 2) Make sure there are no holes or rusting.

### 3. Center Exhaust Pipe

#### A: REMOVAL

After removing the center and front exhaust pipes as one unit, separate them. Refer to "Front Exhaust Pipe" for removal procedure. <Ref. to EX(H4SO 2.0)-7, REMOVAL, Front Exhaust Pipe.>

#### B: INSTALLATION

Install the center exhaust pipe and front exhaust pipe as one unit. Refer to "Front Exhaust Pipe" for installation procedure. <Ref. to EX(H4SO 2.0)-8, INSTALLATION, Front Exhaust Pipe.>

#### C: INSPECTION

- 1) Make sure there are no exhaust leaks from connections and welds.
- 2) Make sure there are no holes or rusting.

## 4. Rear Exhaust Pipe

### A: REMOVAL

1) Separate the rear exhaust pipe from center exhaust pipe.

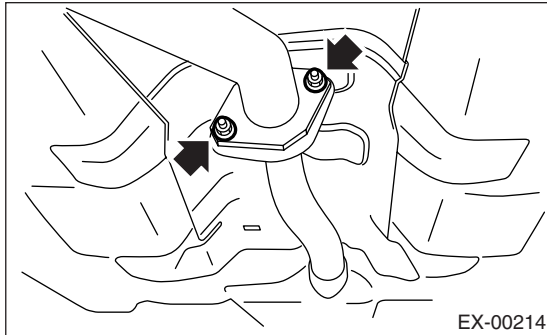

2) Separate the rear exhaust pipe from muffler.

**CAUTION:**  
Be careful not to pull down the rear exhaust pipe.

- LH side

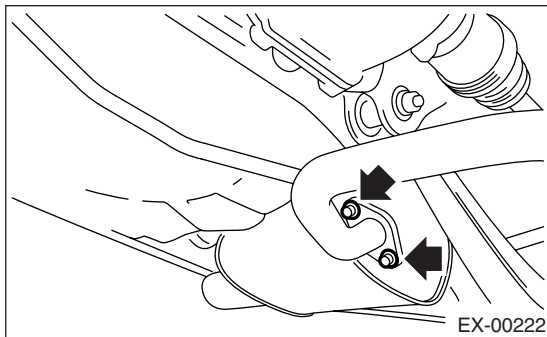

- RH side (2.5 L model)

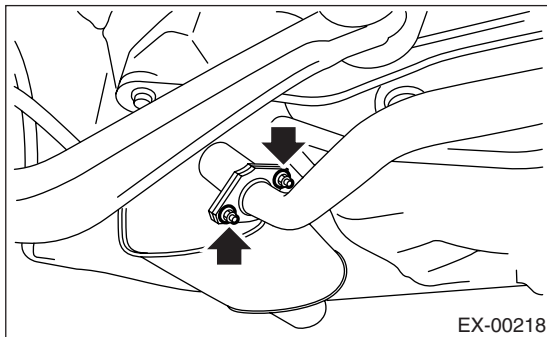

3) Apply a coat of spray type lubricant to mating area of cushion rubber.

4) Remove the rear exhaust pipe bracket from cushion rubber.

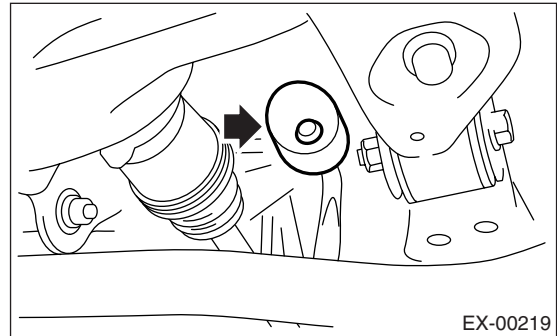

### B: INSTALLATION

1) Apply a coat of spray type lubricant to mating area of cushion rubber.

2) Install the rear exhaust pipe bracket to cushion rubber.

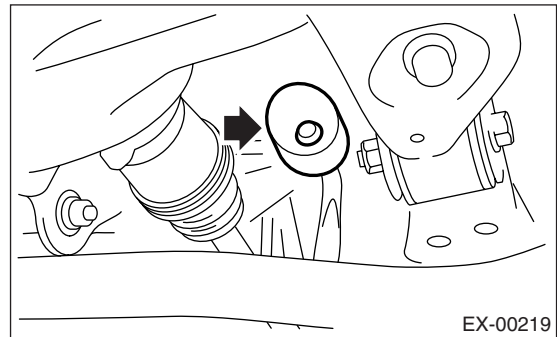

3) Install the rear exhaust pipe to muffler.

**NOTE:**  
Use a new gasket and self-locking nut.

**Tightening torque:**

**48 N·m (4.9 kgf·m, 35.4 ft-lb)**

- LH side

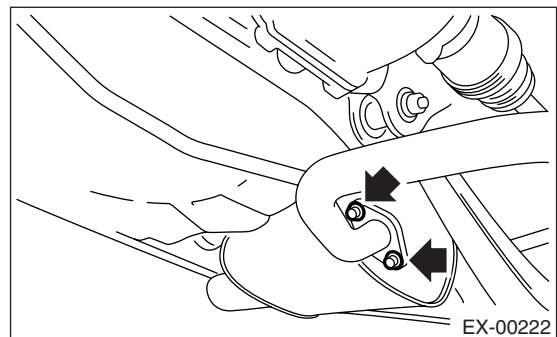

# Rear Exhaust Pipe

## EXHAUST

---

- RH side (2.5 L model)

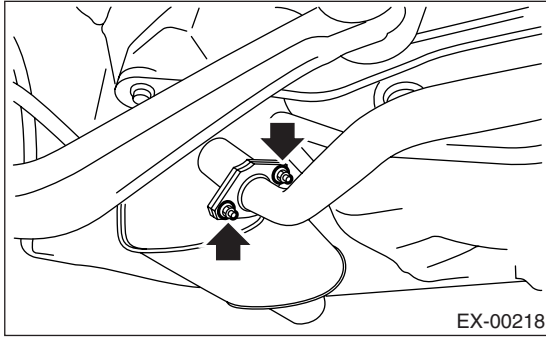

4) Install the rear exhaust pipe to center exhaust pipe.

### **Tightening torque:**

**18 N·m (1.8 kgf·m, 13.0 ft·lb)**

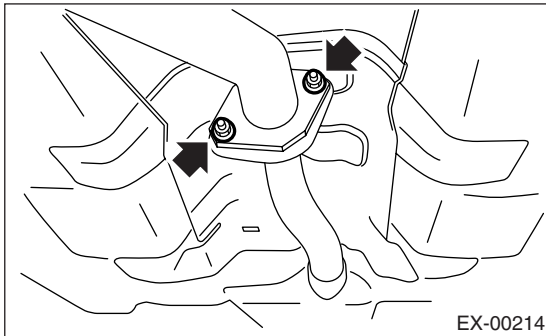

## **C: INSPECTION**

- 1) Make sure there are no exhaust leaks from connections and welds.
- 2) Make sure there are no holes or rusting.
- 3) Make sure the cushion rubber is not worn or cracked.

## 5. Muffler

### A: REMOVAL

1) Separate the muffler from rear exhaust pipe.

- LH side

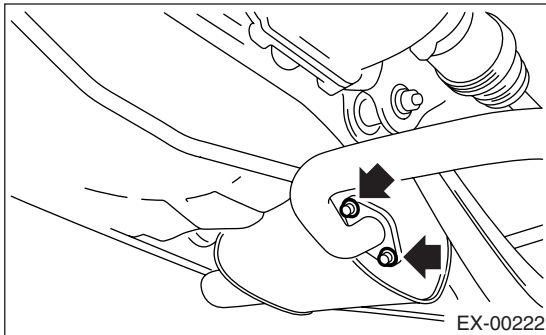

- RH side (2.5 L model)

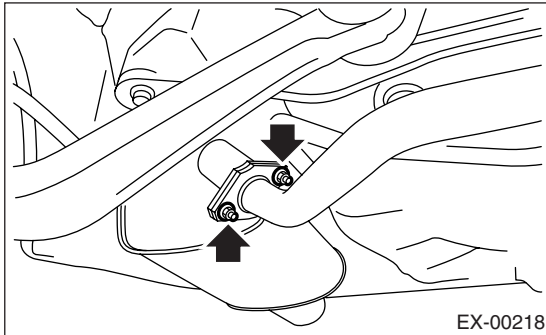

2) Apply a coat of spray type lubricant to mating area of cushion rubber.

- LH side

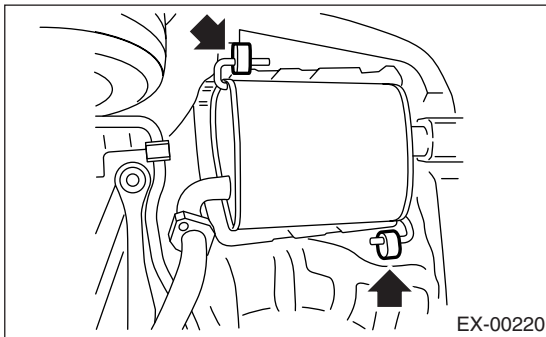

- RH side (2.5 L model)

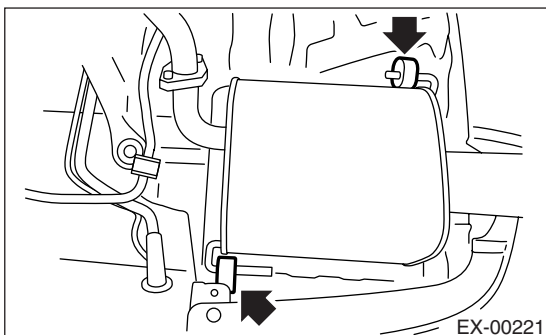

3) Remove the front and rear cushion rubber, and then remove the muffler.

### B: INSTALLATION

Install in the reverse order of removal.

NOTE:

Use a new gasket and self-locking nut.

**Tightening torque:**

**48 N·m (4.9 kgf-m, 35.4 ft-lb)**

- LH side

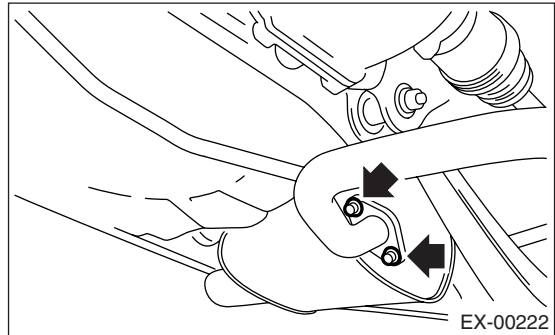

- RH side (2.5 L model)

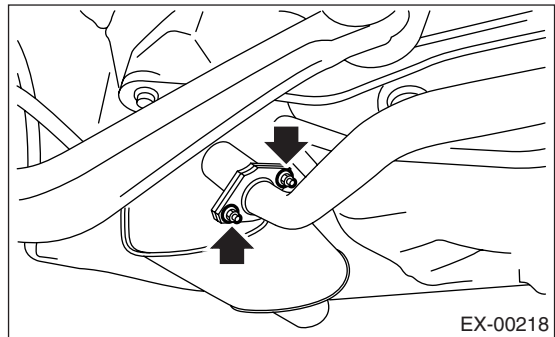

### C: INSPECTION

- 1) Make sure there are no exhaust leaks from connections and welds.
- 2) Make sure there are no holes or rusting.
- 3) Make sure the cushion rubber is not worn or cracked.

# Muffler

EXHAUST

---