

CHASSIS SECTION

This service manual has been prepared to provide SUBARU service personnel with the necessary information and data for the correct maintenance and repair of SUBARU vehicles.

This manual includes the procedures for maintenance, disassembling, reassembling, inspection and adjustment of components and diagnostics for guidance of experienced mechanics.

Please peruse and utilize this manual fully to ensure complete repair work for satisfying our customers by keeping their vehicle in optimum condition. When replacement of parts during repair work is needed, be sure to use SUBARU genuine parts.

All information, illustration and specifications contained in this manual are based on the latest product information available at the time of publication approval.

FRONT SUSPENSION	FS
REAR SUSPENSION	RS
WHEEL AND TIRE SYSTEM	WT
DIFFERENTIAL	DI
TRANSFER CASE	TC
DRIVE SHAFT SYSTEM	DS
ABS	ABS
ABS (DIAGNOSTIC)	ABS
BRAKE	BR
PARKING BRAKE	PB
POWER ASSISTED SYSTEM (POWER STEERING)	PS

ABS (DIAGNOSTIC)

ABS

	Page
1. Basic Diagnostic Procedure	2
2. Check List for Interview	6
3. General Description	10
4. Electrical Components Location.....	12
5. Control Module I/O Signal	14
6. Subaru Select Monitor.....	18
7. Read Diagnostic Trouble Code (DTC)	21
8. Inspection Mode.....	22
9. Clear Memory Mode.....	23
10. ABS Warning Light Illumination Pattern	24
11. List of Diagnostics Trouble Code (DTC)	25
12. Diagnostics Procedure without Diagnostic Trouble Code (DTC)	29
13. Diagnostics Procedure with Diagnostic Trouble Code (DTC)	94
14. General Diagnostics Table.....	174

Basic Diagnostic Procedure

ABS (DIAGNOSTIC)

1. Basic Diagnostic Procedure

A: PROCEDURE

1. WITHOUT SUBARU SELECT MONITOR

CAUTION:

Remove foreign matter (dust, water, etc.) from the ABSCM&H/U connector during removal and installation.

NOTE:

- To check the harness for broken wires or short circuits, shake it while holding it or the connector.
- When the ABS warning light illuminates, read and record DTC indicated by ABS warning light.

Step	Check	Yes	No
1 CHECK PRE-INSPECTION. 1) Ask the customer when and how trouble occurred using interview checklist. <Ref. to ABS-6, Check List for Interview.> 2) Before performing diagnosis, inspect the unit which might influence ABS problem. <Ref. to ABS-10, INSPECTION, General Description.>	Is the unit that might influence the ABS problem normal?	Go to step 2.	Repair or replace each unit.
2 CHECK INDICATION OF DTC. Read the DTC. <Ref. to ABS-21, Read Diagnostic Trouble Code (DTC).>	Is the ABS warning light normal?	Go to step 3.	Inspect using diagnostic chart for ABS warning light failure. <Ref. to ABS-29, Diagnostics Procedure without Diagnostic Trouble Code (DTC).> NOTE: Read the DTC again after inspecting ABS warning light. <Ref. to ABS-21, Read Diagnostic Trouble Code (DTC).>
3 CHECK DTC. Record all DTCs.	Is only the start code issued?	Go to step 4.	Go to step 5.
4 PERFORM THE GENERAL DIAGNOSTICS. 1) Inspect using "General Diagnostics Table". <Ref. to ABS-174, General Diagnostics Table.> 2) Perform the clear memory mode. <Ref. to ABS-23, WITHOUT SUBARU SELECT MONITOR, OPERATION, Clear Memory Mode.> 3) Perform the inspection mode. <Ref. to ABS-22, Inspection Mode.> Read the DTC. <Ref. to ABS-21, Read Diagnostic Trouble Code (DTC).>	Is only the start code issued?	Complete the diagnosis.	Go to step 5.

Basic Diagnostic Procedure

ABS (DIAGNOSTIC)

Step	Check	Yes	No
<p>5 PERFORM THE DIAGNOSIS. 1) Repair trouble cause. NOTE: For DTC list, refer to "List of Diagnostics Trouble Code (DTC)". <Ref. to ABS-25, WITHOUT SUBARU SELECT MONITOR, LIST, List of Diagnostics Trouble Code (DTC).> 2) Perform the clear memory mode. <Ref. to ABS-23, WITHOUT SUBARU SELECT MONITOR, OPERATION, Clear Memory Mode.> 3) Perform the inspection mode. <Ref. to ABS-22, Inspection Mode.> 4) Read the DTC. <Ref. to ABS-21, Read Diagnostic Trouble Code (DTC).></p>	Is only the start code issued?	Complete the diagnosis.	Repeat the step 5 until only start code is issued.

Basic Diagnostic Procedure

ABS (DIAGNOSTIC)

2. WITH SUBARU SELECT MONITOR

CAUTION:

Remove foreign matter (dust, water, etc.) from the ABSCM&H/U connector during removal and installation.

NOTE:

- To check the harness for broken wires or short circuits, shake it while holding it or the connector.
- Check list for interview. <Ref. to ABS-6, Check List for Interview.>

Step	Check	Yes	No
1 CHECK PRE-INSPECTION. 1) Ask the customer when and how trouble occurred using interview checklist. <Ref. to ABS-6, Check List for Interview.> 2) Before performing diagnosis, inspect the unit which might influence the ABS problem. <Ref. to ABS-10, INSPECTION, General Description.>	Is the unit that might influence the ABS problem normal?	Go to step 2.	Repair or replace each unit.
2 CHECK INDICATION OF DTC DISPLAY. 1) Turn the ignition switch to OFF. 2) Connect the Subaru Select Monitor to data link connector. 3) Turn the ignition switch to ON and Subaru Select Monitor to ON. NOTE: If the communication function of Subaru Select Monitor cannot be executed normally, check communication circuit. <Ref. to ABS-94, COMMUNICATION FOR INITIALIZING IMPOSSIBLE, Diagnostics Procedure with Diagnostic Trouble Code (DTC).> 4) Read the DTC. <Ref. to ABS-19, READ CURRENT DATA, OPERATION, Subaru Select Monitor.> 5) Record all DTCs and Freeze Frame Data.	Is DTC displayed?	Go to step 4.	Go to step 3.
3 PERFORM THE GENERAL DIAGNOSTICS. 1) Inspect using a "General Diagnostics Table". <Ref. to ABS-174, General Diagnostics Table.> 2) Perform the clear memory mode. <Ref. to ABS-19, CLEAR MEMORY MODE, OPERATION, Subaru Select Monitor.> 3) Perform the inspection mode. <Ref. to ABS-22, Inspection Mode.> 4) Read the DTC. <Ref. to ABS-18, READ DIAGNOSTIC TROUBLE CODE (DTC), OPERATION, Subaru Select Monitor.> Check DTC is not displayed.	Is the ABS warning light turned off after ignition switch to ON?	Complete the diagnosis.	Go to step 4.

Basic Diagnostic Procedure

ABS (DIAGNOSTIC)

Step	Check	Yes	No
4 PERFORM THE DIAGNOSIS. 1) Refer to "List of Diagnostics Trouble Code (DTC)". <Ref. to ABS-27, WITH SUBARU SELECT MONITOR, LIST, List of Diagnostics Trouble Code (DTC).> 2) Repair trouble cause. 3) Perform the clear memory mode. <Ref. to ABS-19, CLEAR MEMORY MODE, OPERATION, Subaru Select Monitor.> 4) Perform the inspection mode. <Ref. to ABS-22, Inspection Mode.> 5) Read the DTC. <Ref. to ABS-18, READ DIAGNOSTIC TROUBLE CODE (DTC), OPERATION, Subaru Select Monitor.>	Is DTC displayed?	Inspect using "Diagnostics Procedure with Diagnostic Trouble Code (DTC)". <Ref. to ABS-94, Diagnostics Procedure with Diagnostic Trouble Code (DTC).>	Complete the diagnosis.

Check List for Interview

ABS (DIAGNOSTIC)

2. Check List for Interview

A: INSPECTION

Check the following items about the vehicle's state.

1. STATE OF ABS WARNING LIGHT

ABS warning light comes on.	<input type="checkbox"/> Always <input type="checkbox"/> Sometimes <input type="checkbox"/> Only once <input type="checkbox"/> Not come on • When / how long does it come on?		
Ignition key position	<input type="checkbox"/> LOCK <input type="checkbox"/> ACC <input type="checkbox"/> ON (before starting engine) <input type="checkbox"/> START <input type="checkbox"/> ON (after Engine starting, engine is running) <input type="checkbox"/> ON (after Engine starting, engine is at a standstill)		
Timing	<input type="checkbox"/> Immediately after turning the ignition switch to ON <input type="checkbox"/> Immediately after turning the ignition switch to START		
	<input type="checkbox"/> When accelerating	—	km/h
		—	MPH
	<input type="checkbox"/> When driving at a constant speed	km/h	MPH
	<input type="checkbox"/> When decelerating	—	km/h
		—	MPH
	<input type="checkbox"/> When turning to the right	Steering angle:	deg
		Steering time:	Sec.
	<input type="checkbox"/> When turning to the left	Steering angle:	deg
		Steering time:	Sec.
<input type="checkbox"/> When operating other electrical parts • Parts name: • Operating condition:			

Check List for Interview

ABS (DIAGNOSTIC)

2. STATE OF BRAKE WARNING LIGHT

Brake warning light comes on.	<input type="checkbox"/> Always <input type="checkbox"/> Sometimes <input type="checkbox"/> Only once <input type="checkbox"/> Not come on <input type="checkbox"/> When pulling the parking brake lever up. <input type="checkbox"/> When releasing the parking brake lever down. • When / how long does it come on?		
Ignition key position	<input type="checkbox"/> LOCK <input type="checkbox"/> ACC <input type="checkbox"/> ON (before starting engine) <input type="checkbox"/> START <input type="checkbox"/> ON (after Engine starting, engine is running) <input type="checkbox"/> ON (after Engine starting, engine is at a standstill)		
Timing	<input type="checkbox"/> Immediately after turning the ignition to ON <input type="checkbox"/> Immediately after turning the ignition to START		
	<input type="checkbox"/> When accelerating	—	km/h
		—	MPH
	<input type="checkbox"/> When driving at a constant speed	km/h	MPH
	<input type="checkbox"/> When decelerating	—	km/h
		—	MPH
	<input type="checkbox"/> When turning to the right	Steering angle:	deg
		Steering time:	Sec.
	<input type="checkbox"/> When turning to the left	Steering angle:	deg
		Steering time:	Sec.
	<input type="checkbox"/> When operating other electrical parts		
	• Parts name:		
	• Operating condition:		

Check List for Interview

ABS (DIAGNOSTIC)

3. SYMPTOMS

ABS operating condition	<input type="checkbox"/> Does not move.		
	<input type="checkbox"/> Operates only when applying an abrupt brake.	Vehicle speed:	<input type="text"/> km/h
	<input type="text"/> MPH		
	• How to step on brake pedal:		
	a) Operating time:	<input type="text"/> Sec.	
	b) Operating noise: <input type="checkbox"/> Occurs. / <input type="checkbox"/> Does not occur.		
	• What kind of noise?	<input type="checkbox"/> Knocking <input type="checkbox"/> Gong gong <input type="checkbox"/> Bong <input type="checkbox"/> Buzz <input type="checkbox"/> Gong gong buzz <input type="checkbox"/> Others:	
c) Reaction force of brake pedal			
	<input type="checkbox"/> Stick <input type="checkbox"/> Weak pedal resistance <input type="checkbox"/> Strong pedal resistance <input type="checkbox"/> Others:		
Behavior of vehicle	a) Directional stability cannot be obtained or the steering refuses to work when applying brakes: <input type="checkbox"/> Yes / <input type="checkbox"/> No		
	• When:	<input type="checkbox"/> When turning to the right <input type="checkbox"/> When turning to the left <input type="checkbox"/> When spinning <input type="checkbox"/> Others:	
	b) Directional stability cannot be obtained or the steering refuses to work when accelerating: <input type="checkbox"/> Yes / <input type="checkbox"/> No		
	• When:	<input type="checkbox"/> When turning to the right <input type="checkbox"/> When turning to the left <input type="checkbox"/> When spinning <input type="checkbox"/> Others:	
	c) Poor brake performance: <input type="checkbox"/> Yes / <input type="checkbox"/> No		
	• What kind:	<input type="checkbox"/> Long braking/stopping distance <input type="checkbox"/> Brakes lock or drag <input type="checkbox"/> Long pedal stroke <input type="checkbox"/> Pedal sticks. <input type="checkbox"/> Others:	
	d) Poor acceleration: <input type="checkbox"/> Yes / <input type="checkbox"/> No		
	• What kind:	<input type="checkbox"/> Not accelerate <input type="checkbox"/> Engine stalls. <input type="checkbox"/> Others:	
	e) Occurrence of vibration: <input type="checkbox"/> Yes / <input type="checkbox"/> No		
	• Where		
	• What kind:		
f) Occurrence of noise: <input type="checkbox"/> Yes / <input type="checkbox"/> No			
• Where			
• What kind:			
g) Other troubles occurred: <input type="checkbox"/> Yes / <input type="checkbox"/> No			
• What kind:			

Check List for Interview

ABS (DIAGNOSTIC)

4. CONDITIONS UNDER WHICH TROUBLE OCCURS

Environment	a) Weather	<input type="checkbox"/> Fine <input type="checkbox"/> Cloudy <input type="checkbox"/> Rainy <input type="checkbox"/> Snowy <input type="checkbox"/> Others:	
	b) Ambient temperature	°C (°F)	
	c) Road	<input type="checkbox"/> Inner city <input type="checkbox"/> Suburbs <input type="checkbox"/> Highway <input type="checkbox"/> Local street <input type="checkbox"/> Uphill <input type="checkbox"/> Downhill <input type="checkbox"/> Paved road <input type="checkbox"/> Gravel road <input type="checkbox"/> Muddy road <input type="checkbox"/> Sandy place <input type="checkbox"/> Others:	
	d) Road surface	<input type="checkbox"/> Dried <input type="checkbox"/> Wet <input type="checkbox"/> Covered with fresh snow <input type="checkbox"/> Covered with hardened snow <input type="checkbox"/> Frozen slope <input type="checkbox"/> Others:	
Condition	a) Brakes	Deceleration: G	
		<input type="checkbox"/> Intermittent / <input type="checkbox"/> Temporary	
	b) Accelerator	Acceleration: G	
		<input type="checkbox"/> Intermittent / <input type="checkbox"/> Temporary	
	c) Vehicle speed	km/h	MPH
		<input type="checkbox"/> Advancing <input type="checkbox"/> When accelerating <input type="checkbox"/> When decelerating <input type="checkbox"/> At low speed <input type="checkbox"/> When turning <input type="checkbox"/> Others:	
	d) Tire inflation pressure	Front RH tire:	kPa
		Front LH tire:	kPa
		Rear RH tire:	kPa
		Rear LH tire:	kPa
	e) Degree of wear	Front RH tire:	
		Front LH tire:	
		Rear RH tire:	
		Rear LH tire:	
f) Genuine parts are used.:	<input type="checkbox"/> Yes / <input type="checkbox"/> No		
g) Tire chain is attached:	<input type="checkbox"/> Yes / <input type="checkbox"/> No		
h) T-type tire is used.:	<input type="checkbox"/> Yes / <input type="checkbox"/> No		
i) Condition of suspension alignment:			
j) Loading state:			
k) Repair parts are used.:	<input type="checkbox"/> Yes / <input type="checkbox"/> No		
• Contents:			
l) Others:			

3. General Description

A: CAUTION

1. SUPPLEMENTAL RESTRAINT SYSTEM “AIRBAG”

Airbag system wiring harness is routed near the ABS wheel speed sensor and ABSCM&H/U.

CAUTION:

- All airbag system wiring harness and connectors are colored yellow. Do not use electrical test equipment on these circuit.
- Be careful not to damage the Airbag system wiring harness when servicing the ABS wheel speed sensor and ABSCM&H/U.

B: INSPECTION

Before performing diagnostics, check the following items which might affect ABS problems:

1. BATTERY

Measure the battery voltage and check electrolyte.

Standard voltage: 12 V or more

Specific gravity: More than 1.260

2. BRAKE FLUID

- 1) Check the brake fluid level.
- 2) Check the brake fluid leakage.

3. HYDRAULIC UNIT

Check the hydraulic unit.

- With brake tester <Ref. to ABS-10, CHECKING THE HYDRAULIC UNIT ABS OPERATION WITH BRAKE TESTER, INSPECTION, ABS Control Module and Hydraulic Control Unit (ABSCM&H/U).>
- Without brake tester <Ref. to ABS-9, CHECKING THE HYDRAULIC UNIT ABS OPERATION BY PRESSURE GAUGE, INSPECTION, ABS Control Module and Hydraulic Control Unit (ABSCM&H/U).>

4. BRAKE DRAG

Check for brake drag.

5. BRAKE PAD AND ROTOR

Check the brake pad and rotor.



- Front <Ref. to BR-19, INSPECTION, Front Brake Pad.> <Ref. to BR-20, INSPECTION, Front Disc Rotor.>
- Rear <Ref. to BR-24, INSPECTION, Rear Brake Pad.> <Ref. to BR-25, INSPECTION, Rear Disc Rotor.> or <Ref. to BR-30, INSPECTION, Rear Drum Brake Shoe.> <Ref. to BR-31, INSPECTION, Rear Drum Brake Drum.>

6. TIRE

Check the tire specifications, tire wear and air pressure. <Ref. to WT-2, SPECIFICATION, General Description.>

C: PREPARATION TOOL

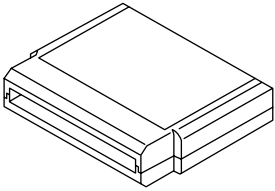
1. SPECIAL TOOL

ILLUSTRATION	TOOL NUMBER	DESCRIPTION	REMARKS
 ST24082AA230	24082AA230 (Newly adopted tool)	CARTRIDGE	Troubleshooting for electrical systems.
 ST22771AA030	22771AA030	SUBARU SELECT MONITOR KIT	Troubleshooting for electrical systems. <ul style="list-style-type: none"> • English: 22771AA030 (Without printer) • German: 22771AA070 (Without printer) • French: 22771AA080 (Without printer) • Spanish: 22771AA090 (Without printer)

2. GENERAL TOOL

TOOL NAME	REMARKS
Circuit tester	Used for measuring resistance, voltage and ampere.
Oscilloscope	Used for measuring sensor.

Electrical Components Location

ABS (DIAGNOSTIC)

4. Electrical Components Location

A: LOCATION

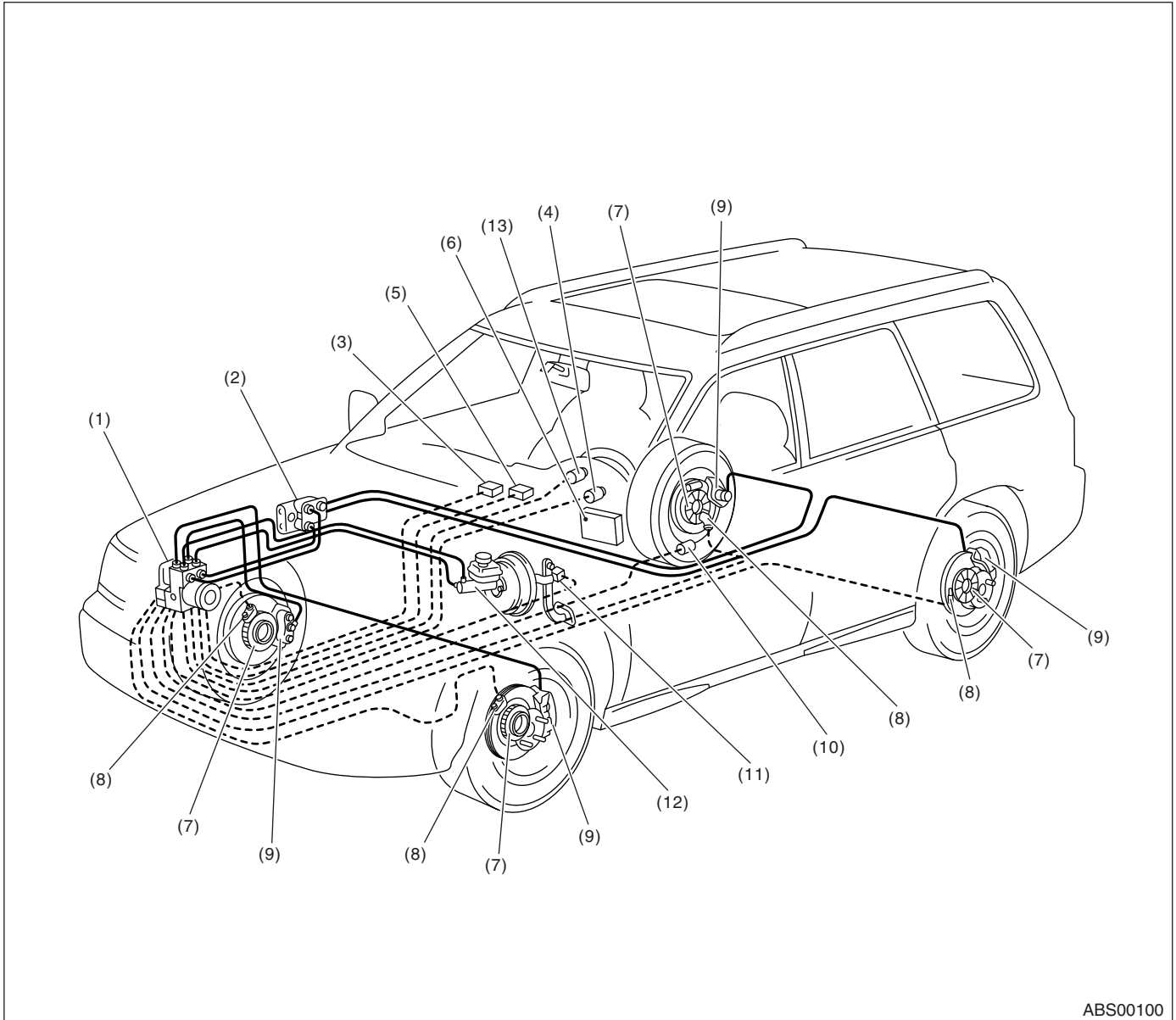

ABS00100

- | | | |
|---|---|------------------------------|
| (1) ABS control module and hydraulic control unit (ABSCM&H/U) | (5) Data link connector (for Subaru Select Monitor) | (9) Wheel cylinder |
| (2) Proportioning valve (model without EBD) | (6) Transmission control module (AT model) | (10) G sensor |
| (3) Diagnosis connector | (7) Tone wheel | (11) Stop light switch |
| (4) ABS warning light | (8) ABS wheel speed sensor | (12) Master cylinder |
| | | (13) Brake&EBD warning light |

Electrical Components Location

ABS (DIAGNOSTIC)

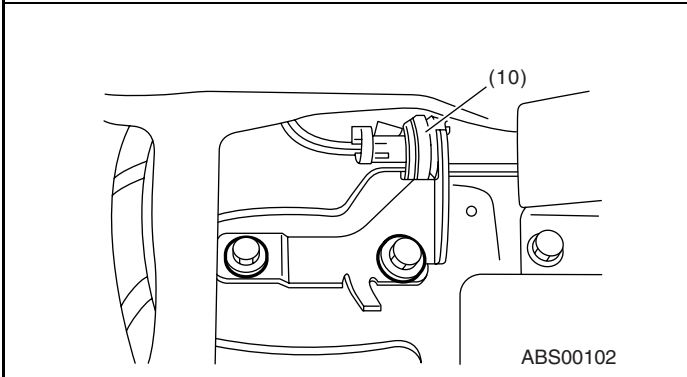
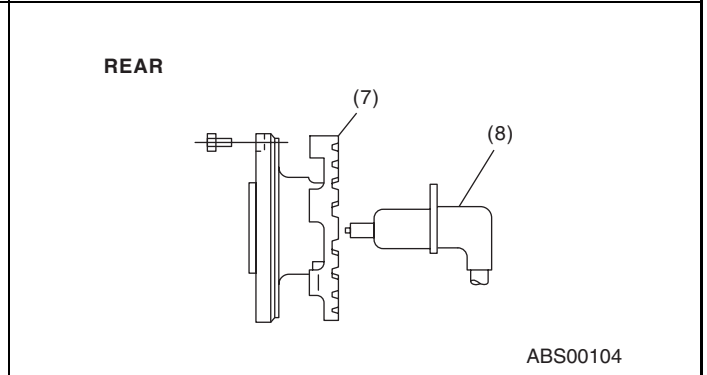
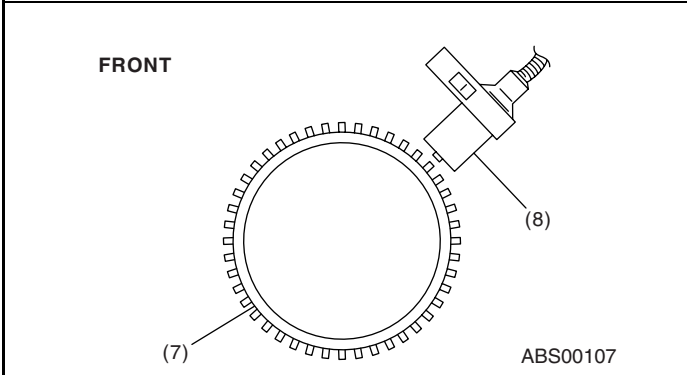
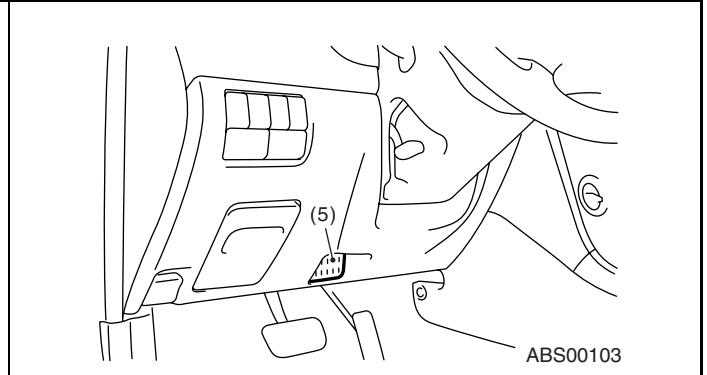
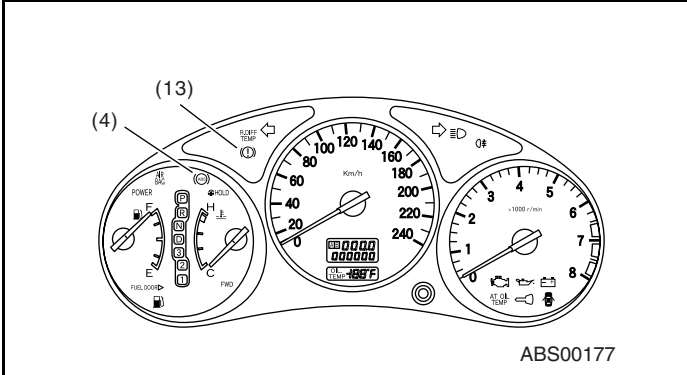
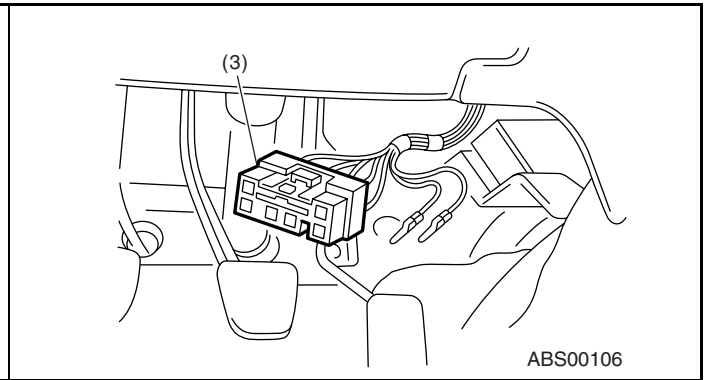
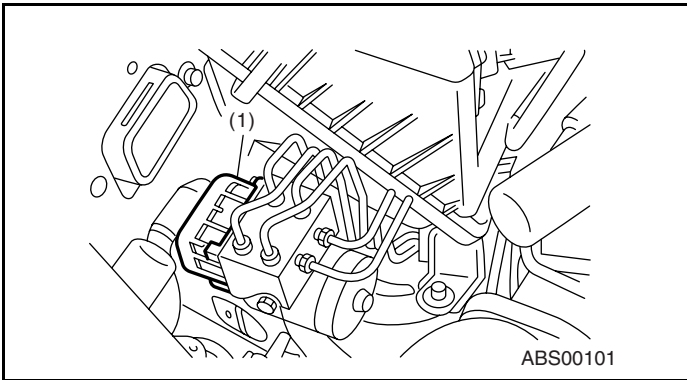

5. Control Module I/O Signal

A: ELECTRICAL SPECIFICATION

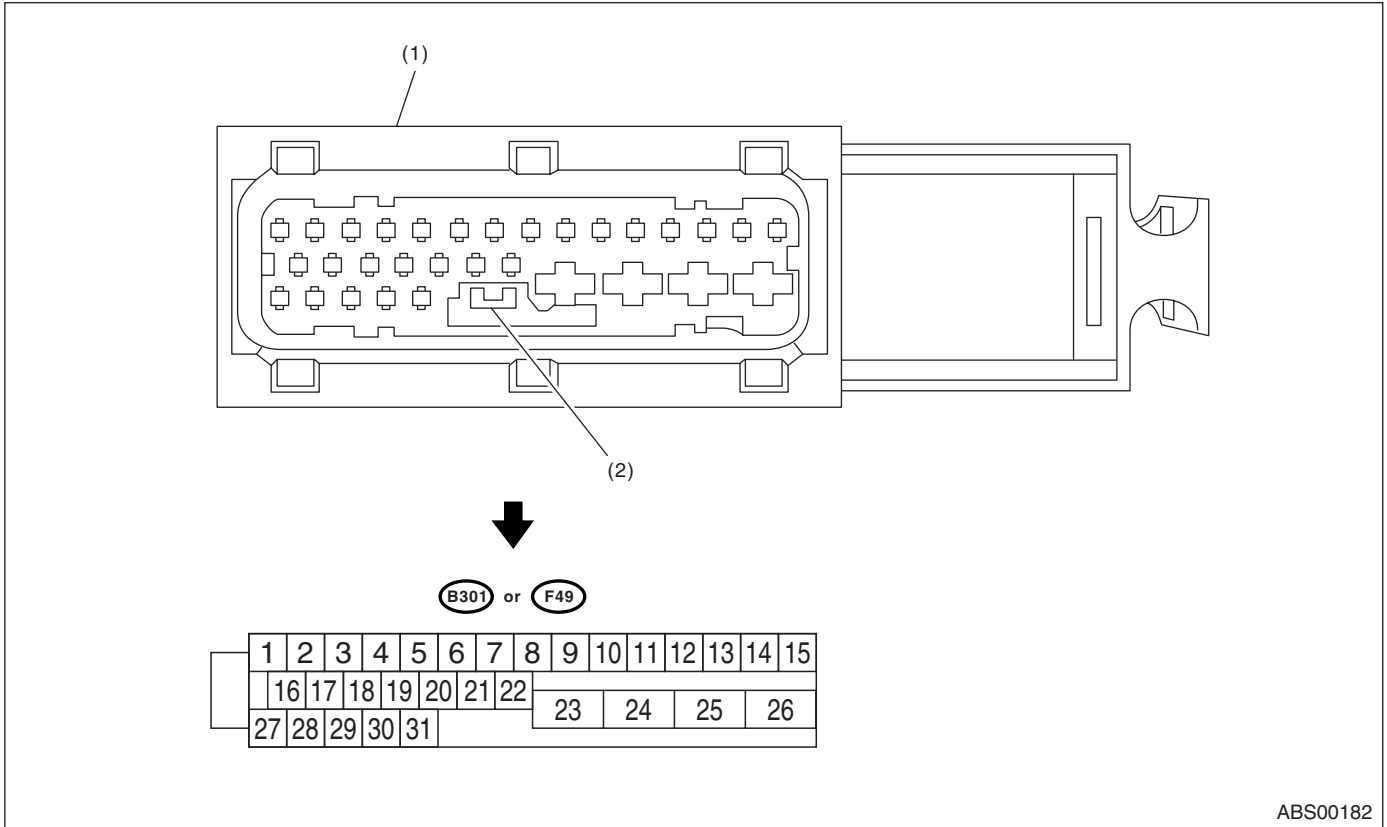

- (1) ABS control module and hydraulic control unit (ABSCM&H/U) connector (2) Connector switch

NOTE:

- The terminal numbers in ABSCM&H/U connector are as shown in the figure.
- When the connector is removed from ABSCM&H/U, the connector switch closes the circuit between terminal No. 22 and No. 23. The ABS warning light illuminates.

Control Module I/O Signal

ABS (DIAGNOSTIC)

Contents		Terminal No. (+) — (-)	Input/Output signal
			Measured value and measuring conditions
ABS wheel speed sensor*2 (Wheel speed sensor)	Front LH wheel	9 — 10	0.12 — 1 V (When it is 20 Hz)
	Front RH wheel	11 — 12	
	Rear LH wheel	7 — 8	
	Rear RH wheel	14 — 15	
Valve relay power supply*1		24 — 23	10 — 15 V
Motor relay power supply*1		25 — 23	10 — 15 V
G sensor*2	Power supply	30 — 28	4.75 — 5.25 V
	Ground	28	—
	Output	6 — 28	2.1 — 2.5 V when vehicle is in horizontal position.
Stop light switch*1		2 — 23	Less than 1.5 V when the stop light is OFF and, 10 — 15 V when the stop light is ON.
ABS warning light*2		22 — 23	Less than 1.5 V within 1.5 seconds immediately after ignition switch has been turned to ON, and 10 — 15 V after 1.5 seconds has elapsed.
Brake warning light*2 (EBD warning light)		21 — 23	Less than 1.5 V within 1.5 seconds immediately after ignition switch has been turned to ON, and 10 — 15 V after 1.5 seconds has elapsed.
AT ABS signal (AT models only)		31 — 23	Less than 1.5 V when the ABS control still operates and more than 5.5 V when ABS does not operate.
ABS operation signal monitor		3 — 23	Less than 1.5 V when the ABS control still operates and more than 5.5 V when ABS does not operate.
Subaru Select Monitor*2	Data is received.	20 — 23	Less than 1.5 V when no data is received.
	Data is sent.	5 — 23	4.75 — 5.25 V when no data is sent.
ABS diagnosis connector	Terminal No. 3	29 — 23	10 — 15 V when ignition switch is ON.
	Terminal No. 6	4 — 23	10 — 15 V when ignition switch is ON.
Power supply*1		1 — 23	10 — 15 V when ignition switch is ON.
Grounding line		23	—
Grounding line		26	—

*1: Measure the I/O signal voltage after removing the connector from the ABSCM&H/U terminal.

*2: Measure the I/O signal voltage at connector (B98), (B37), (B38), (F48) or (F103).

Control Module I/O Signal

ABS (DIAGNOSTIC)

B: WIRING DIAGRAM

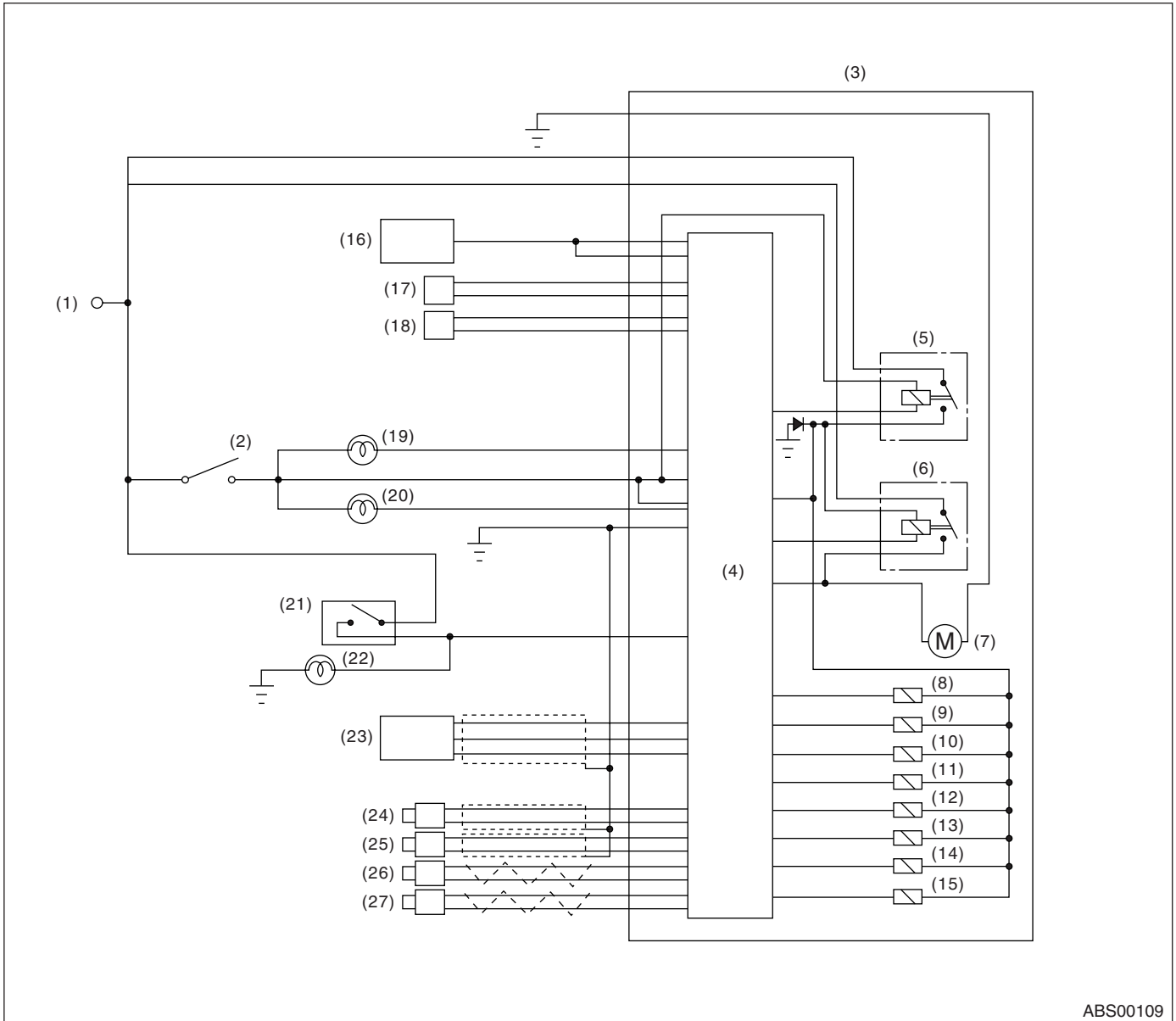

ABS00109

- | | | |
|---|---|--------------------------------------|
| (1) Battery | (11) Front outlet solenoid valve RH | (21) Stop light switch |
| (2) Ignition switch | (12) Rear inlet solenoid valve LH | (22) Stop light |
| (3) ABS control module and hydraulic control unit (ABSCM&H/U) | (13) Rear outlet solenoid valve LH | (23) G sensor |
| (4) ABS control module area | (14) Rear inlet solenoid valve RH | (24) Front ABS wheel speed sensor LH |
| (5) Valve relay | (15) Rear outlet solenoid valve RH | (25) Front ABS wheel speed sensor RH |
| (6) Motor relay | (16) Transmission control module (AT model) | (26) Rear ABS wheel speed sensor LH |
| (7) Motor | (17) Diagnosis connector | (27) Rear ABS wheel speed sensor RH |
| (8) Front inlet solenoid valve LH | (18) Data link connector | |
| (9) Front outlet solenoid valve LH | (19) Brake warning light | |
| (10) Front inlet solenoid valve RH | (20) ABS warning light | |

C: WAVEFORM

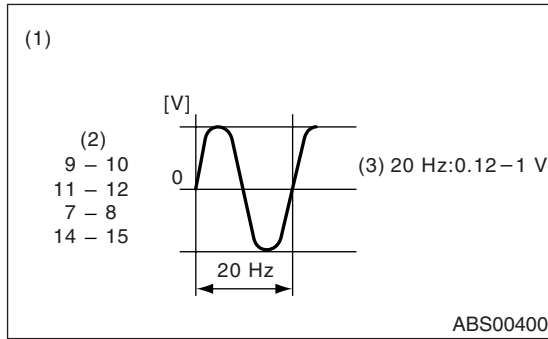

- (1) ABS wheel speed sensor
- (2) Terminal No.
- (3) Standard output voltage

6. Subaru Select Monitor

A: OPERATION

1. READ DIAGNOSTIC TROUBLE CODE (DTC)

1) Prepare the Subaru Select Monitor kit. <Ref. to ABS-11, SPECIAL TOOL, PREPARATION TOOL, General Description.>

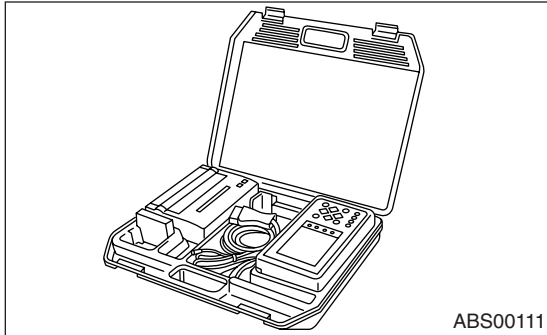

2) Connect the diagnosis cable to Subaru Select Monitor.

3) Insert the cartridge into Subaru Select Monitor. <Ref. to ABS-11, SPECIAL TOOL, PREPARATION TOOL, General Description.>

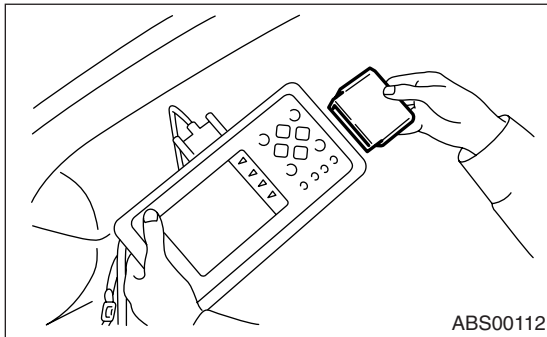

4) Connect the Subaru Select Monitor to data link connector.

(1) Data link connector is located in the lower portion of the instrument panel (on the driver's side).

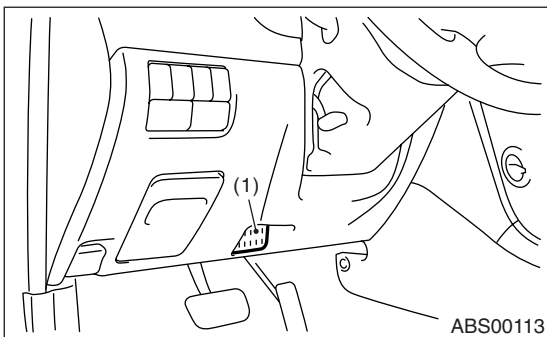

(1) Data link connector

(2) Connect the diagnosis cable to data link connector.

CAUTION:

Do not connect the scan tools except for Subaru Select Monitor and OBD-II general scan tool.

5) Turn the ignition switch to ON (engine OFF) and Subaru Select Monitor switch to ON.

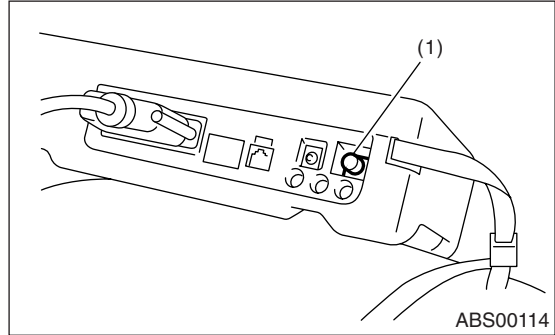

(1) Power switch

6) On the «Main Menu» display screen, select the {Each System Check} and press [YES] key.

7) On the «System Selection Menu» display screen, select the {Brake Control System} and press [YES] key.

8) Press the [YES] key after the {ABS} is displayed.

9) On the «ABS Diagnosis» display screen, select the {Diagnostic Code(s) Display} and press [YES] key.

10) On the «Diagnostic Code(s) Display» display screen, select the {Current Diagnostic Code(s)} or {History Diagnostic Code(s)} and press [YES] key.

NOTE:

- For detailed operation procedure, refer to the «SUBARU SELECT MONITOR OPERATION MANUAL».

- For detailed concerning the DTC, refer to the LIST OF DIAGNOSTICS TROUBLE CODE (DTC). <Ref. to ABS-25, List of Diagnostics Trouble Code (DTC).>

- A maximum of 3 DTCs are displayed in order of occurrence.

- If a particular DTC is not properly stored in memory (due to a drop in ABSCM&H/U power supply, etc.) when a problem occurs, the DTC, followed by a question mark "?", appears on the Subaru Select Monitor display. This shows it may be an unreliable reading.

Display screen	Contents to be monitored
Latest	The most recent DTC appears on Subaru Select Monitor display.
Old	The second most recent DTC appears on Subaru Select Monitor display.
Older	The third most recent DTC appears on Subaru Select Monitor display.
Reference	DTC issued after elapse of a specified period of time.

2. READ CURRENT DATA

- 1) On the «Main Menu» display screen, select the {Each System Check} and press [YES] key.
 - 2) On the «System Selection Menu» display screen, select the {Brake Control System} and press [YES] key.
 - 3) Press the [YES] key after displayed the information of ABS type.
 - 4) On the «Brake Control Diagnosis» display screen, select the {Current Data Display & Save} and press [YES] key.
 - 5) On the «Data Display Menu» display screen, select the {Data Display} and press [YES] key.
 - 6) Using the scroll key, move the display screen up or down until necessary data is shown.
- A list of the support data is shown in the following table.

Display screen	Contents to be monitored	Unit of measure
FR Wheel Speed	Wheel speed detected by front ABS wheel speed sensor RH is displayed	km/h or MPH
FL Wheel Speed	Wheel speed detected by front ABS wheel speed sensor LH is displayed	km/h or MPH
RR Wheel Speed	Wheel speed detected by rear ABS wheel speed sensor RH is displayed	km/h or MPH
RL Wheel Speed	Wheel speed detected by rear ABS wheel speed sensor LH is displayed	km/h or MPH
Stop Light Switch	Stop light switch signal	ON or OFF
Stop Light Switch	Stop light switch monitor voltage is displayed.	V
G Sensor Output Signal	Voltage equivalent to vehicle acceleration detected by analog G sensor is displayed.	V
Valve Relay Signal	Valve Relay Signal	ON or OFF
Motor Relay Signal	Motor Relay Signal	ON or OFF
ABS Signal to TCM	ABS operation signal from ABS control module to TCM	ON or OFF
ABS Warning Light	ON operation of ABS warning light is displayed.	ON or OFF
EBD Warning Light	ON operation of EBD warning light is displayed.	ON or OFF
Motor Relay Monitor	Operating condition of motor relay is displayed.	ON or OFF
Valve Relay Monitor	Operating condition of the valve relay is displayed.	ON or OFF
CCM Signal	ABS operation signal from ABS control module to TCM	ON or OFF

NOTE:

For detailed operation procedure, refer to the “SUBARU SELECT MONITOR OPERATION MANUAL”.

3. CLEAR MEMORY MODE

- 1) On the «Main Menu» display screen, select the {Each System Check} and press [YES] key.
- 2) On the «System Select Menu» display screen, select the {Brake Control System} and press [YES] key.
- 3) Press the [YES] key after displayed the information of engine type.

- 4) On the «Brake Control Diagnosis» display screen, select the {Clear Memory} and press [YES] key.

Display	Contents to be monitored
Clear memory?	Function of clearing DTC.

Subaru Select Monitor

ABS (DIAGNOSTIC)

5) When the “Done” and “turn ignition switch to OFF” are shown on display screen, turn the Subaru Select Monitor and ignition switch to OFF.

NOTE:

For detailed operation procedure, refer to the “SUBARU SELECT MONITOR OPERATION MANUAL”.

4. ABS SEQUENCE CONTROL

Display	Contents to be monitored	Index No.
ABS sequence control	Perform ABS sequence control by operating valve and pump motor sequentially.	<Ref. to ABS-11, ABS Sequence Control.>

5. FREEZE FRAME DATA

NOTE:

- Data stored at the time of trouble occurrence is shown on display.
- Each time trouble occurs, the latest information is stored in the freeze frame data in memory.
- Freeze frame data will be memorized maximum to three.
- If freeze frame data is not properly stored in memory (due to a drop in ABSCM power supply, etc.), a DTC, preceded by a question mark “?”, appears on the Subaru Select Monitor display. This shows it may be an unreliable reading.

Display	Contents to be monitored
FR wheel speed	Wheel speed detected by front ABS wheel speed sensor RH is displayed in km/h or MPH.
FL wheel speed	Wheel speed detected by front ABS wheel speed sensor LH is displayed in km/h or MPH.
RR wheel speed	Wheel speed detected by rear ABS wheel speed sensor RH is displayed in km/h or MPH.
RL wheel speed	Wheel speed detected by rear ABS wheel speed sensor LH is displayed in km/h or MPH.
ABSCM power voltage	Power (in volts) supplied to ABSCM&H/U appears on the Subaru Select Monitor display.
G sensor output voltage	Voltage equivalent to vehicle acceleration detected by analog G sensor is displayed.
Motor relay monitor	Motor relay operation monitor signal
Stop light switch	Stop light switch signal
ABS signal to TCM	ABS operation signal from ABSCM to TCM
ABS-AT control	ABS operation signal from ABSCM to TCM

Display	Contents to be monitored
ABS operation signal	ABS operation signal
Condition of malfunction	Displays if the malfunction has occurred to ABS only, or to ABS and EBD.

6. ANALOG DATA ARE DISPLAYED

Display	Contents to be monitored
FR wheel speed	Wheel speed detected by front ABS wheel speed sensor RH is displayed in km/h or MPH.
FL wheel speed	Wheel speed detected by front ABS wheel speed sensor LH is displayed in km/h or MPH.
RR wheel speed	Wheel speed detected by rear ABS wheel speed sensor RH is displayed in km/h or MPH.
RL wheel speed	Wheel speed detected by rear ABS wheel speed sensor LH is displayed in km/h or MPH.
Stop light switch	Stop light switch monitor voltage is displayed.
G sensor output voltage	Refers to vehicle acceleration detecting by analog G sensor. It appears on the select monitor display in volts.

7. ON/OFF DATA ARE DISPLAYED

Display	Contents to be monitored
Stop light switch	Stop light switch signal
Valve relay signal	Valve relay signal
Motor relay signal	Motor relay signal
ABS signal to TCM	ABS operation signal from ABS control module to TCM
ABS warning light	ABS warning light
Valve relay monitor	Valve relay operation monitor signal
Motor relay monitor	Motor relay operation monitor signal
CCM signal	ABS operation signal from ABS control module to TCM

7. Read Diagnostic Trouble Code (DTC)

A: OPERATION

1. WITHOUT SUBARU SELECT MONITOR

1) Take out the diagnosis connector from side of driver's seat.

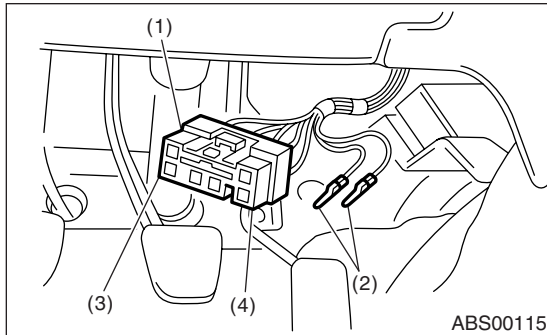

- (1) Diagnosis connector
- (2) Ground terminal
- (3) Terminal 3
- (4) Terminal 6

- 2) Turn the ignition switch to OFF.
- 3) Connect the diagnosis connector terminal 6 to ground terminal.
- 4) Turn the ignition switch to ON.
- 5) ABS warning light is set in the diagnostic mode and blinks to identify DTC.
- 6) After the start code (11) is shown, the DTCs will be shown in order of the last information first. These repeat for a maximum of 3 minutes.

NOTE:

- When there are no DTCs in memory, only the start code (11) is shown.
- When on-board diagnosis of the ABSCM detects a problem, the information (up to a maximum of three) will be stored in EEPROM as a DTC. When there are more than three, the most recent three will be stored. (Stored codes will stay in memory until they are cleared.)

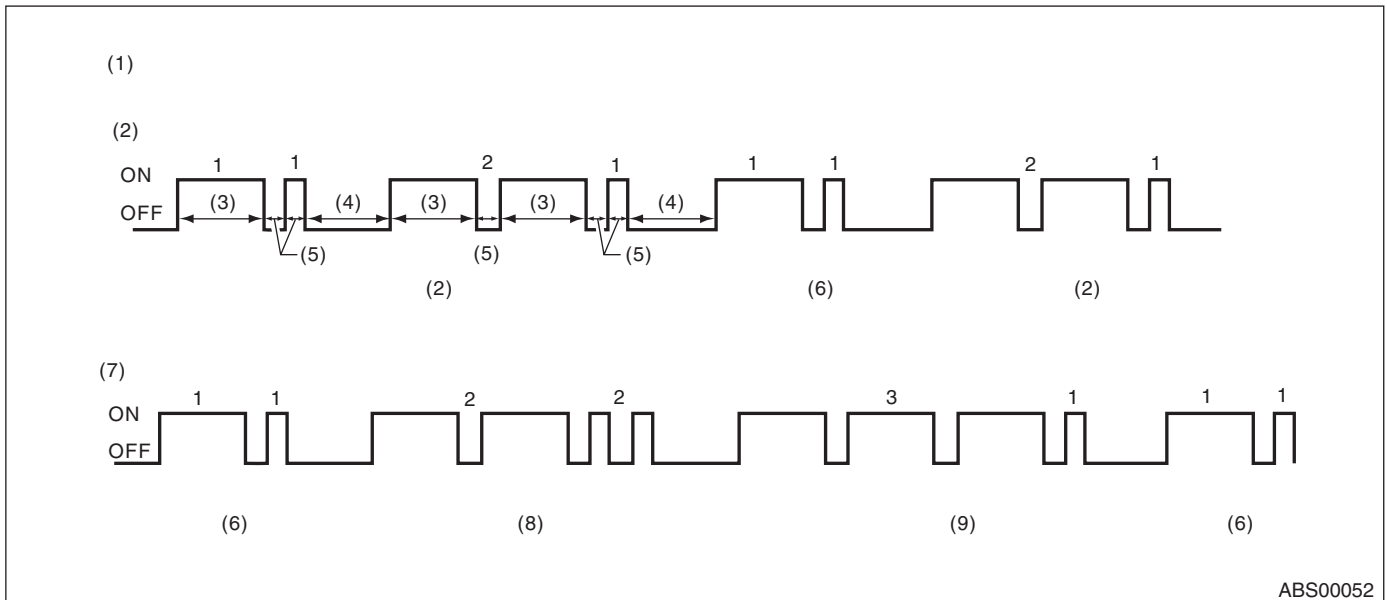

- | | | |
|---------------------------------------|----------------|---|
| (1) Example of DTC indication | (4) 1.0 sec. | (7) Diagnostic trouble code (DTC): 22, 31 |
| (2) Diagnostic trouble code (DTC): 21 | (5) 0.3 sec. | (8) Diagnostic trouble code (DTC): 22 |
| (3) 1.2 sec. | (6) Start code | (9) Diagnostic trouble code (DTC): 31 |

2. WITH SUBARU SELECT MONITOR

Refer to "SUBARU SELECT MONITOR" for information about how to obtain and understand DTCs. <Ref. to ABS-18, Subaru Select Monitor.>

8. Inspection Mode

A: OPERATION

Reproduce the condition under which the problem has occurred as much as possible.

Drive the vehicle at a speed more than 40 km/h (25 MPH) for at least 1 minute.

9. Clear Memory Mode

A: OPERATION

1. WITHOUT SUBARU SELECT MONITOR

1) After calling up a DTC, gripped the diagnosis connector terminal 6 from ground terminal.

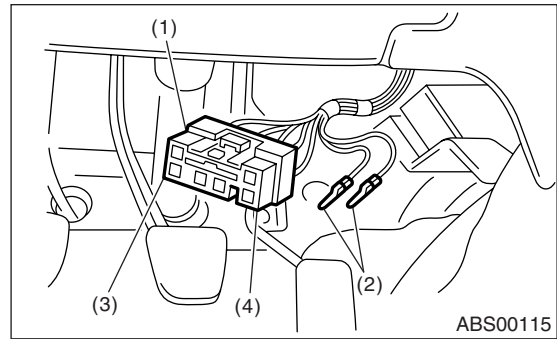

- (1) Diagnosis connector
- (2) Ground terminal
- (3) Terminal 3
- (4) Terminal 6

2) Repeat 3 times within approx. 12 seconds; connecting and disconnecting terminal 6 and ground terminal for at least 0.2 seconds each time.

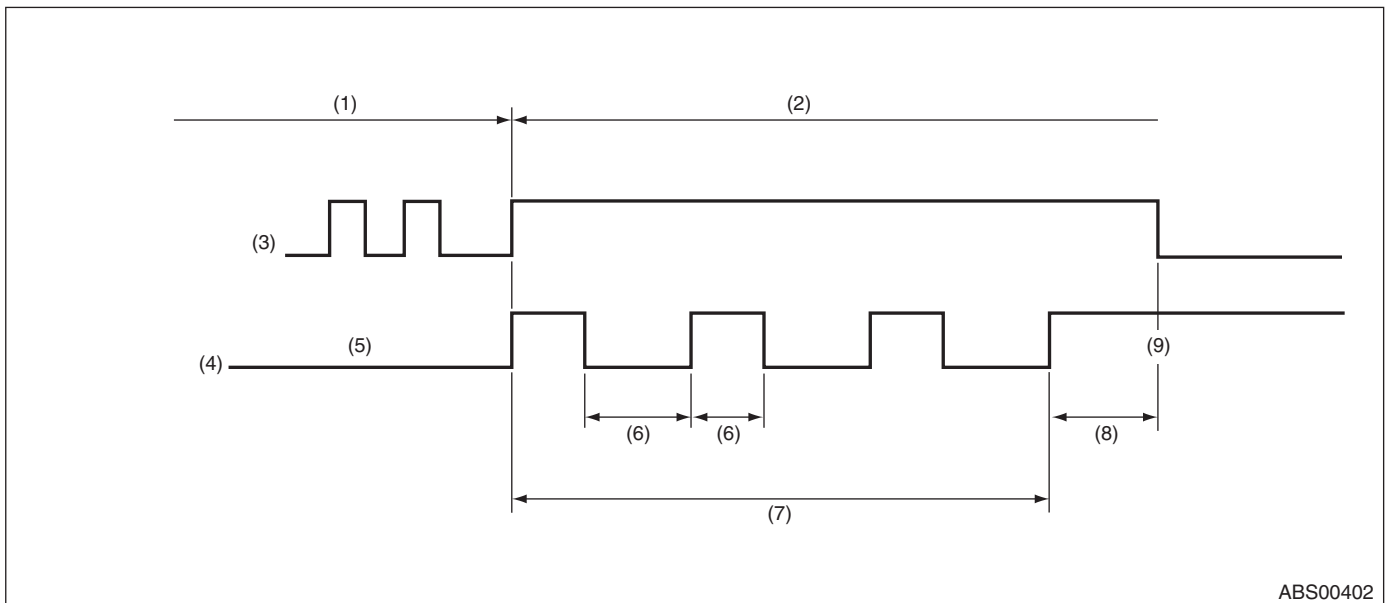

ABS00402

- | | | |
|---|----------------------|---------------------------|
| (1) Diagnostic trouble code (DTC) indication mode | (4) Terminal 8 | (8) 1.5 sec. |
| (2) Clear memory mode | (5) GND (Low level) | (9) GND open (High level) |
| (3) ABS warning light | (6) 0.2 sec. or more | |
| | (7) 12 sec. or less | |

NOTE:

After the diagnostics is completed, make sure to clear memory. Make sure only start code (11) is shown after memory is cleared.

2. WITH SUBARU SELECT MONITOR

Refer to "Subaru Select Monitor" for information about how to clear DTC. <Ref. to ABS-18, Subaru Select Monitor.>

ABS Warning Light Illumination Pattern

ABS (DIAGNOSTIC)

10.ABS Warning Light Illumination Pattern

A: INSPECTION

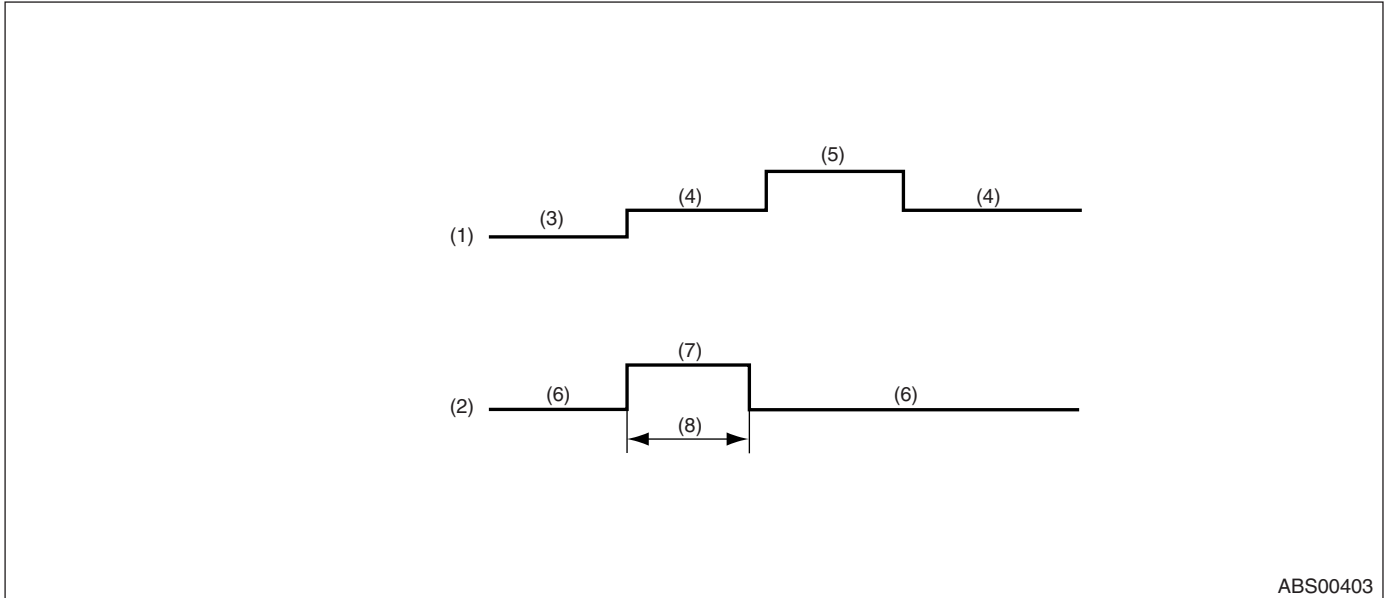

ABS00403

- | | | |
|-----------------------|--------------|-----------------|
| (1) Ignition switch | (4) ON | (7) Illuminates |
| (2) ABS warning light | (5) START | (8) 1.5 sec. |
| (3) OFF | (6) Goes out | |

1) When the ABS warning light does not illuminate in accordance with this illumination pattern, there must be an electrical malfunction.

2) When the ABS warning light remains constantly OFF, repair the ABS warning light circuit or diagnosis circuit. <Ref. to ABS-29, Diagnostics Procedure without Diagnostic Trouble Code (DTC).>

NOTE:

Even though the ABS warning light does not go out 1.5 seconds after it illuminates, the ABS system operates normally when the ABS warning light goes out while driving at approx. 12 km/h (7 MPH). However, the Anti-lock brakes do not work while ABS warning light is illuminated.

11. List of Diagnostics Trouble Code (DTC)

A: LIST

1. WITHOUT SUBARU SELECT MONITOR

DTC	Contents of diagnosis		Index No.
11	Start code • DTC is shown after start code. • Only start code is shown in normal condition.		—
21	ABS wheel speed sensor malfunction (Open circuit or input voltage too high)	Front ABS sensor RH	<Ref. to ABS-45, DTC 21 ABNORMAL ABS SENSOR (OPEN CIRCUIT OR INPUT VOLTAGE TOO HIGH) (FRONT RH), Diagnostics Procedure without Diagnostic Trouble Code (DTC).>
23		Front ABS sensor LH	<Ref. to ABS-45, DTC 23 ABNORMAL ABS SENSOR (OPEN CIRCUIT OR INPUT VOLTAGE TOO HIGH) (FRONT LH), Diagnostics Procedure without Diagnostic Trouble Code (DTC).>
25		Rear ABS sensor RH	<Ref. to ABS-45, DTC 25 ABNORMAL ABS SENSOR (OPEN CIRCUIT OR INPUT VOLTAGE TOO HIGH) (REAR RH), Diagnostics Procedure without Diagnostic Trouble Code (DTC).>
27		Rear ABS sensor LH	<Ref. to ABS-46, DTC 27 ABNORMAL ABS SENSOR (OPEN CIRCUIT OR INPUT VOLTAGE TOO HIGH) (REAR LH), Diagnostics Procedure without Diagnostic Trouble Code (DTC).>
22	ABS wheel speed sensor malfunction (Abnormal ABS sensor signal)	Front ABS sensor RH	<Ref. to ABS-53, DTC 22 ABNORMAL ABS SENSOR (ABNORMAL ABS SENSOR SIGNAL) (FRONT RH), Diagnostics Procedure without Diagnostic Trouble Code (DTC).>
24		Front ABS sensor LH	<Ref. to ABS-53, DTC 24 ABNORMAL ABS SENSOR (ABNORMAL ABS SENSOR SIGNAL) (FRONT LH), Diagnostics Procedure without Diagnostic Trouble Code (DTC).>
26		Rear ABS sensor RH	<Ref. to ABS-53, DTC 26 ABNORMAL ABS SENSOR (ABNORMAL ABS SENSOR SIGNAL) (REAR RH), Diagnostics Procedure without Diagnostic Trouble Code (DTC).>
28		Rear ABS sensor LH	<Ref. to ABS-54, DTC 28 ABNORMAL ABS SENSOR (ABNORMAL ABS SENSOR SIGNAL) (REAR LH), Diagnostics Procedure without Diagnostic Trouble Code (DTC).>
29		Any one of four	<Ref. to ABS-61, DTC 29 ABNORMAL ABS SENSOR (ABNORMAL ABS SENSOR SIGNAL) (ANY ONE OF FOUR), Diagnostics Procedure without Diagnostic Trouble Code (DTC).>

List of Diagnostics Trouble Code (DTC)

ABS (DIAGNOSTIC)

DTC	Contents of diagnosis	Index No.
31	Abnormal solenoid valve circuit(s) in ABS control module and hydraulic unit	Front inlet valve RH <Ref. to ABS-67, DTC 31 ABNORMAL INLET SOLENOID VALVE CIRCUIT(S) IN ABSCM&H/U (FRONT RH), Diagnostics Procedure without Diagnostic Trouble Code (DTC).>
32		Front outlet valve RH <Ref. to ABS-71, DTC 32 ABNORMAL OUTLET SOLENOID VALVE CIRCUIT(S) IN ABSCM&H/U (FRONT RH), Diagnostics Procedure without Diagnostic Trouble Code (DTC).>
33		Front inlet valve LH <Ref. to ABS-67, DTC 33 ABNORMAL INLET SOLENOID VALVE CIRCUIT(S) IN ABSCM&H/U (FRONT LH), Diagnostics Procedure without Diagnostic Trouble Code (DTC).>
34		Front outlet valve LH <Ref. to ABS-71, DTC 34 ABNORMAL OUTLET SOLENOID VALVE CIRCUIT(S) IN ABSCM&H/U (FRONT LH), Diagnostics Procedure without Diagnostic Trouble Code (DTC).>
35		Rear inlet valve RH <Ref. to ABS-67, DTC 35 ABNORMAL INLET SOLENOID VALVE CIRCUIT(S) IN ABSCM&H/U (REAR RH), Diagnostics Procedure without Diagnostic Trouble Code (DTC).>
36		Rear outlet valve RH <Ref. to ABS-71, DTC 36 ABNORMAL OUTLET SOLENOID VALVE CIRCUIT(S) IN ABSCM&H/U (REAR RH), Diagnostics Procedure without Diagnostic Trouble Code (DTC).>
37		Rear inlet valve LH <Ref. to ABS-68, DTC 37 ABNORMAL INLET SOLENOID VALVE CIRCUIT(S) IN ABSCM&H/U (REAR LH), Diagnostics Procedure without Diagnostic Trouble Code (DTC).>
38		Rear outlet valve LH <Ref. to ABS-72, DTC 38 ABNORMAL OUTLET SOLENOID VALVE CIRCUIT(S) IN ABSCM&H/U (REAR LH), Diagnostics Procedure without Diagnostic Trouble Code (DTC).>
41	Abnormal ABS control module	<Ref. to ABS-75, DTC 41 ABNORMAL ABS CONTROL MODULE, Diagnostics Procedure without Diagnostic Trouble Code (DTC).>
42	Source voltage is abnormal.	<Ref. to ABS-77, DTC 42 SOURCE VOLTAGE IS ABNORMAL., Diagnostics Procedure without Diagnostic Trouble Code (DTC).>
44	A combination of AT control abnormal	<Ref. to ABS-80, DTC 44 A COMBINATION OF AT CONTROL ABNORMAL, Diagnostics Procedure without Diagnostic Trouble Code (DTC).>
51	Abnormal valve relay	<Ref. to ABS-83, DTC 51 ABNORMAL VALVE RELAY, Diagnostics Procedure without Diagnostic Trouble Code (DTC).>
52	Abnormal motor and/or motor relay	<Ref. to ABS-85, DTC 52 ABNORMAL MOTOR AND/OR MOTOR RELAY, Diagnostics Procedure without Diagnostic Trouble Code (DTC).>
54	Abnormal stop light switch	<Ref. to ABS-88, DTC 54 ABNORMAL STOP LIGHT SWITCH, Diagnostics Procedure without Diagnostic Trouble Code (DTC).>
56	Abnormal G sensor output voltage	<Ref. to ABS-90, DTC 56 ABNORMAL G SENSOR OUTPUT VOLTAGE, Diagnostics Procedure without Diagnostic Trouble Code (DTC).>

List of Diagnostics Trouble Code (DTC)

ABS (DIAGNOSTIC)

2. WITH SUBARU SELECT MONITOR

DTC	Sub code No.	Display screen	Contents of diagnosis	Index No.
—	—	Communication for initializing impossible	Select monitor communication failure	<Ref. to ABS-94, COMMUNICATION FOR INITIALIZING IMPOSSIBLE, Diagnostics Procedure with Diagnostic Trouble Code (DTC).>
—	—	No trouble code	Although no trouble code appears on the select monitor display, the ABS warning light remains on.	<Ref. to ABS-97, NO TROUBLE CODE, Diagnostics Procedure with Diagnostic Trouble Code (DTC).>
21	4A02	Open or short circuit in Front ABS sensor RH circuit	Open or short circuit in Front ABS sensor RH circuit	<Ref. to ABS-101, DTC 21 OPEN OR SHORT CIRCUIT IN FRONT RIGHT ABS SENSOR CIRCUIT, Diagnostics Procedure with Diagnostic Trouble Code (DTC).>
22	48C5, 4945 48E5, 4845 4905, 4885	Front ABS sensor RH abnormal signal	Front ABS sensor RH abnormal signal	<Ref. to ABS-110, DTC 22 FRONT RIGHT ABNORMAL ABS SENSOR SIGNAL, Diagnostics Procedure with Diagnostic Trouble Code (DTC).>
23	4202	Open or short circuit in Front ABS sensor LH circuit	Open or short circuit in Front ABS sensor LH circuit	<Ref. to ABS-101, DTC 23 OPEN OR SHORT CIRCUIT IN FRONT LEFT ABS SENSOR CIRCUIT, Diagnostics Procedure with Diagnostic Trouble Code (DTC).>
24	40C5, 4145 40E5, 4045 4105, 4085	Front ABS sensor LH abnormal signal	Front ABS sensor LH abnormal signal	<Ref. to ABS-110, DTC 24 FRONT LEFT ABNORMAL ABS SENSOR SIGNAL, Diagnostics Procedure with Diagnostic Trouble Code (DTC).>
25	4602	Open or short circuit in Rear ABS sensor RH circuit	Open or short circuit in Rear ABS sensor RH circuit	<Ref. to ABS-101, DTC 25 OPEN OR SHORT CIRCUIT IN REAR RIGHT ABS SENSOR CIRCUIT, Diagnostics Procedure with Diagnostic Trouble Code (DTC).>
26	44C5, 4545 44E5, 4445 4505, 4485	Rear ABS sensor RH abnormal signal	Rear ABS sensor RH abnormal signal	<Ref. to ABS-110, DTC 26 REAR RIGHT ABNORMAL ABS SENSOR SIGNAL, Diagnostics Procedure with Diagnostic Trouble Code (DTC).>
27	4E02	Open or short circuit in Rear ABS sensor LH circuit	Open or short circuit in Rear ABS sensor LH circuit	<Ref. to ABS-102, DTC 27 OPEN OR SHORT CIRCUIT IN REAR LEFT ABS SENSOR CIRCUIT, Diagnostics Procedure with Diagnostic Trouble Code (DTC).>
28	4CC5, 4D45 4CE5, 4C45 4D05, 4C85	Rear ABS sensor LH abnormal signal	Rear ABS sensor LH abnormal signal	<Ref. to ABS-111, DTC 28 REAR LEFT ABNORMAL ABS SENSOR SIGNAL, Diagnostics Procedure with Diagnostic Trouble Code (DTC).>
29	5080 50C0	Abnormal ABS sensor signal on any one of four sensor	Abnormal ABS sensor signal on any one of four	<Ref. to ABS-118, DTC 29 ABNORMAL ABS SENSOR SIGNAL ON ANY ONE OF FOUR SENSOR, Diagnostics Procedure with Diagnostic Trouble Code (DTC).>
31	3200	Front inlet valve RH malfunction	Front inlet valve RH malfunction	<Ref. to ABS-124, DTC 31 FRONT RIGHT INLET VALVE MALFUNCTION, Diagnostics Procedure with Diagnostic Trouble Code (DTC).>
32	3600	Front outlet valve RH malfunction	Front outlet valve RH malfunction	<Ref. to ABS-128, DTC 32 FRONT RIGHT OUTLET VALVE MALFUNCTION, Diagnostics Procedure with Diagnostic Trouble Code (DTC).>
33	2200	Front inlet valve LH malfunction	Front inlet valve LH malfunction	<Ref. to ABS-124, DTC 33 FRONT LEFT INLET VALVE MALFUNCTION, Diagnostics Procedure with Diagnostic Trouble Code (DTC).>
34	2600	Front outlet valve LH malfunction	Front outlet valve LH malfunction	<Ref. to ABS-128, DTC 34 FRONT LEFT OUTLET VALVE MALFUNCTION, Diagnostics Procedure with Diagnostic Trouble Code (DTC).>
35	2A00	Rear inlet valve RH malfunction	Rear inlet valve RH malfunction	<Ref. to ABS-124, DTC 35 REAR RIGHT INLET VALVE MALFUNCTION, Diagnostics Procedure with Diagnostic Trouble Code (DTC).>
36	2E00	Rear outlet valve RH malfunction	Rear outlet valve RH malfunction	<Ref. to ABS-128, DTC 36 REAR RIGHT OUTLET VALVE MALFUNCTION, Diagnostics Procedure with Diagnostic Trouble Code (DTC).>
37	3A00	Rear inlet valve LH malfunction	Rear inlet valve LH malfunction	<Ref. to ABS-125, DTC 37 REAR LEFT INLET VALVE MALFUNCTION, Diagnostics Procedure with Diagnostic Trouble Code (DTC).>

List of Diagnostics Trouble Code (DTC)

ABS (DIAGNOSTIC)

DTC	Sub code No.	Display screen	Contents of diagnosis	Index No.
38	3E00	Rear outlet valve LH malfunction	Rear outlet valve LH malfunction	<Ref. to ABS-129, DTC 38 REAR LEFT OUTLET VALVE MALFUNCTION, Diagnostics Procedure with Diagnostic Trouble Code (DTC).>
41	02A0, 0040, 0020, 02C0, 00E0, 0340, 0140, 0160, 0280, 0080, 0300	ABS control module malfunction	ABS control module and hydraulic control unit malfunction	<Ref. to ABS-132, DTC 41 ABS CONTROL MODULE MALFUNCTION, Diagnostics Procedure with Diagnostic Trouble Code (DTC).>
42	5A00	Power supply voltage too low	Power supply voltage too low	<Ref. to ABS-134, DTC 42 POWER SUPPLY VOLTAGE TOO LOW, Diagnostics Procedure with Diagnostic Trouble Code (DTC).>
	5A80	Power supply voltage too high	Power supply voltage too high	<Ref. to ABS-137, DTC 42 POWER SUPPLY VOLTAGE TOO HIGH, Diagnostics Procedure with Diagnostic Trouble Code (DTC).>
44	1600	ABS-AT control (Non Controlled)	ABS-AT control (Non Controlled)	<Ref. to ABS-140, DTC 44 ABS-AT CONTROL (NON CONTROLLED), Diagnostics Procedure with Diagnostic Trouble Code (DTC).>
	1500	ABS-AT control (Controlled)	ABS-AT control (Controlled)	<Ref. to ABS-142, DTC 44 ABS-AT CONTROL (CONTROLLED), Diagnostics Procedure with Diagnostic Trouble Code (DTC).>
51	0C80 0EA0	Valve relay malfunction	Valve relay malfunction	<Ref. to ABS-144, DTC 51 VALVE RELAY MALFUNCTION, Diagnostics Procedure with Diagnostic Trouble Code (DTC).>
	0C40	Valve relay ON failure	Valve relay ON failure	<Ref. to ABS-146, DTC 51 VALVE RELAY ON FAILURE, Diagnostics Procedure with Diagnostic Trouble Code (DTC).>
52	10A1	Open circuit in motor relay circuit	Open circuit in motor relay circuit	<Ref. to ABS-148, DTC 52 OPEN CIRCUIT IN MOTOR RELAY CIRCUIT, Diagnostics Procedure with Diagnostic Trouble Code (DTC).>
	10E1	Motor relay ON failure	Motor relay ON failure	<Ref. to ABS-150, DTC 52 MOTOR RELAY ON FAILURE, Diagnostics Procedure with Diagnostic Trouble Code (DTC).>
	10C1	Motor malfunction	Motor malfunction	<Ref. to ABS-152, DTC 52 MOTOR MALFUNCTION, Diagnostics Procedure with Diagnostic Trouble Code (DTC).>
54	5600	Stop light switch signal circuit malfunction	Stop light switch signal circuit malfunction	<Ref. to ABS-155, DTC 54 STOP LIGHT SWITCH SIGNAL CIRCUIT MALFUNCTION, Diagnostics Procedure with Diagnostic Trouble Code (DTC).>
56	7600	Open or short circuit in G sensor circuit	Open or short circuit in G sensor circuit	<Ref. to ABS-157, DTC 56 OPEN OR SHORT CIRCUIT IN G SENSOR CIRCUIT, Diagnostics Procedure with Diagnostic Trouble Code (DTC).>
	7580	Battery short in G sensor circuit	Battery short in G sensor circuit	<Ref. to ABS-161, DTC 56 BATTERY SHORT IN G SENSOR CIRCUIT, Diagnostics Procedure with Diagnostic Trouble Code (DTC).>
	7540	Abnormal G sensor high μ output	Abnormal G sensor high μ output	<Ref. to ABS-166, DTC 56 ABNORMAL G SENSOR HIGH μ OUTPUT, Diagnostics Procedure with Diagnostic Trouble Code (DTC).>
	7500	Detection of G sensor stick	Detection of G sensor stick	<Ref. to ABS-170, DTC 56 DETECTION OF G SENSOR STICK, Diagnostics Procedure with Diagnostic Trouble Code (DTC).>

12. Diagnostics Procedure without Diagnostic Trouble Code (DTC)

A: ABS WARNING LIGHT DOES NOT COME ON.

DIAGNOSIS:

ABS warning light circuit is open or shorted.

TROUBLE SYMPTOM:

When the ignition switch is turned to ON (engine OFF), ABS warning light does not come on.

Diagnostics Procedure without Diagnostic Trouble Code (DTC)

ABS (DIAGNOSTIC)

WIRING DIAGRAM:

- LHD model

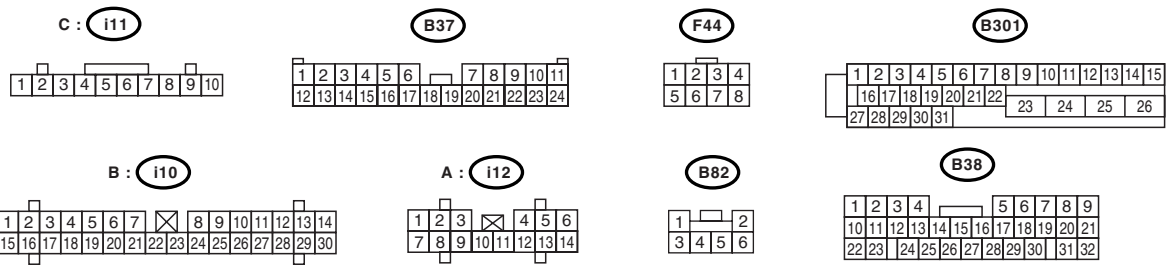
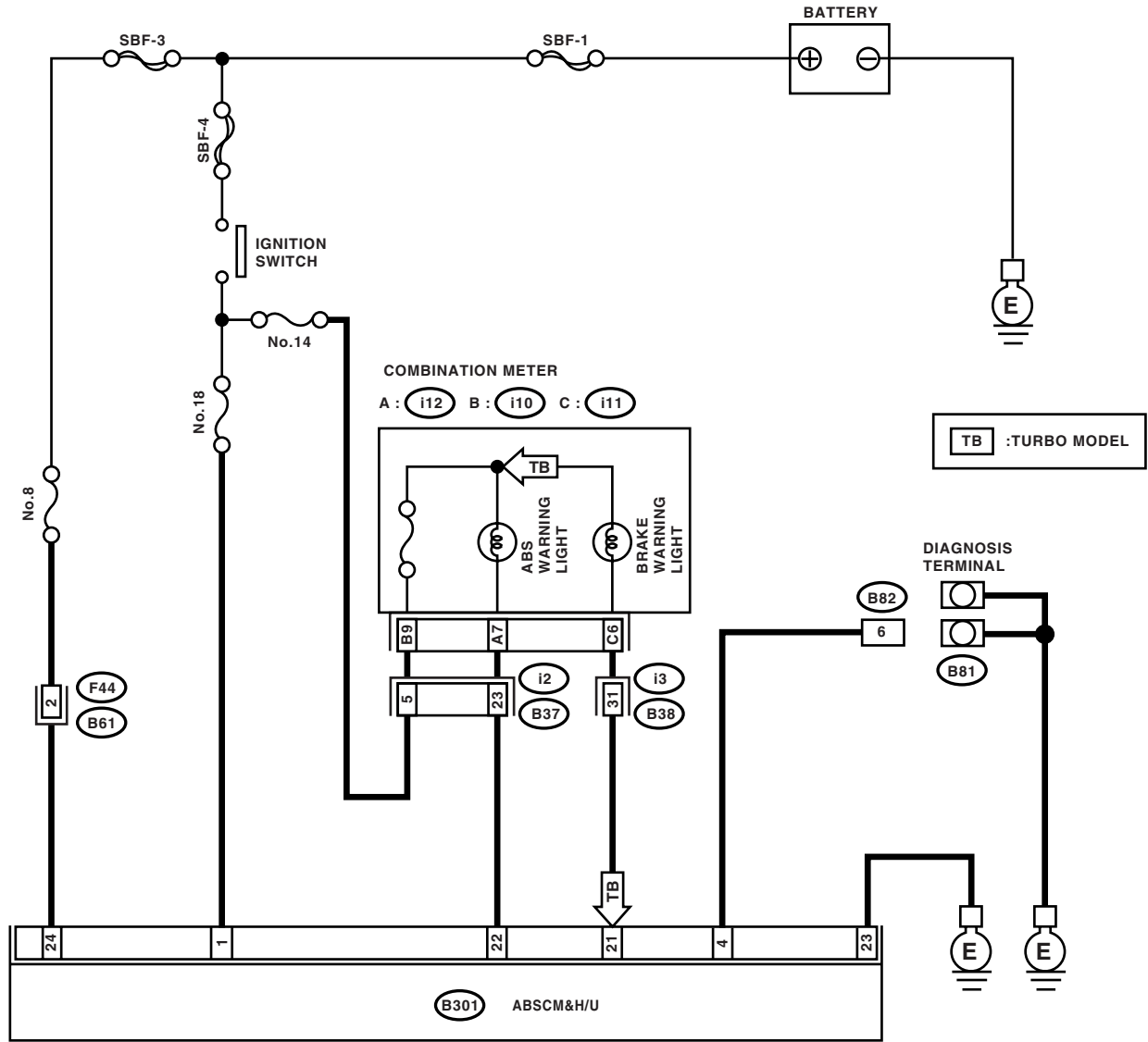

ABS00451

Diagnostics Procedure without Diagnostic Trouble Code (DTC)

ABS (DIAGNOSTIC)

- RHD model

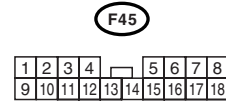
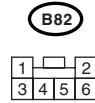
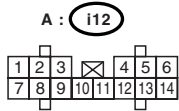
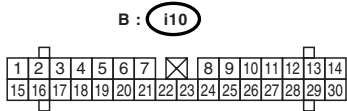
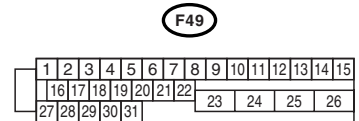
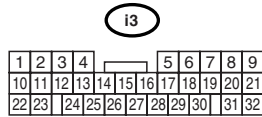
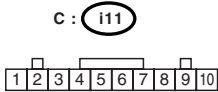
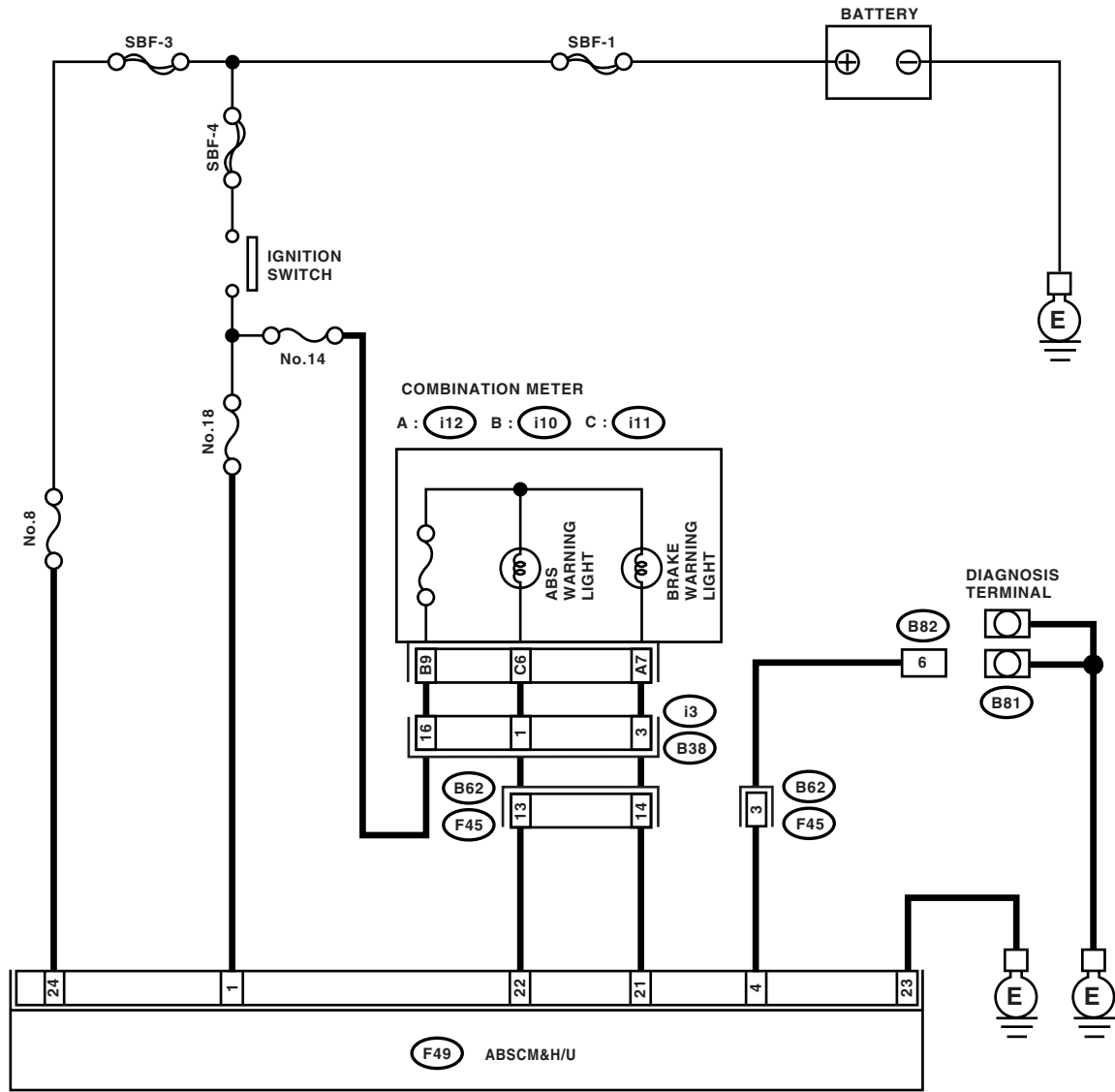

ABS00452

Diagnostics Procedure without Diagnostic Trouble Code (DTC)

ABS (DIAGNOSTIC)

Step	Check	Yes	No
1 CHECK IF OTHER WARNING LIGHTS TURN ON. Turn the ignition switch to ON (engine OFF).	Are other warning lights turned on?	Go to step 2.	Repair the combination meter. <Ref. to IDI-10, Combination Meter Assembly.>
2 CHECK ABS AND BRAKE WARNING LIGHT BULB. 1) Turn the ignition switch to OFF. 2) Remove the combination meter. 3) Remove the ABS warning light and brake warning light bulb.	Is the ABS warning light bulb open?	Replace the ABS and brake warning light bulb. <Ref. to IDI-10, Combination Meter Assembly.>	Go to step 3.
3 CHECK BATTERY SHORT OF ABS AND BRAKE WARNING LIGHT HARNESS. 1) Disconnect the connector (i2) or (B62) from connector (B37) or (F45). 2) Measure the voltage between connector (i2) or (B62) and chassis ground. Connector & terminal LHD: (i2) No. 23 (+) — Chassis ground (-): RHD: (B62) No. 13 (+) — Chassis ground (-):	Is the voltage less than 3 V?	Go to step 4.	Repair the warning light harness.
4 CHECK BATTERY SHORT OF ABS AND BRAKE WARNING LIGHT HARNESS. 1) Turn the ignition switch to ON. 2) Measure the voltage between connector (i2) or (B62) and chassis ground. Connector & terminal LHD: (i2) No. 23 (+) — Chassis ground (-): RHD: (B62) No. 13 (+) — Chassis ground (-):	Is the voltage less than 3 V?	Go to step 5.	Repair the warning light harness.
5 CHECK WIRING HARNESS. 1) Turn the ignition switch to OFF. 2) Install the combination meter. 3) Turn the ignition switch to ON. 4) Measure the voltage between connector (i2) or (B62) and chassis ground. Connector & terminal LHD: (i2) No. 23 (+) — Chassis ground (-): RHD: (B62) No. 13 (+) — Chassis ground (-):	Is the voltage 10 — 15 V?	Go to step 6.	Repair the wiring harness.
6 CHECK BATTERY SHORT OF ABS AND BRAKE WARNING LIGHT HARNESS. 1) Turn the ignition switch to OFF. 2) Measure the voltage between connector (B37) or (F45) and chassis ground. Connector & terminal LHD: (B37) No. 23 (+) — Chassis ground (-): RHD: (F45) No. 13 (+) — Chassis ground (-):	Is the voltage less than 3 V?	Go to step 7.	Repair the wiring harness.

Diagnostics Procedure without Diagnostic Trouble Code (DTC)

ABS (DIAGNOSTIC)

Step	Check	Yes	No
7 CHECK BATTERY SHORT OF ABS AND BRAKE WARNING LIGHT HARNESS. 1) Turn the ignition switch to ON. 2) Measure the voltage between connector (B37) or (F45) and chassis ground. <i>Connector & terminal</i> <i>LHD: (B37) No. 23 (+) — Chassis ground (-):</i> <i>RHD: (F45) No. 13 (+) — Chassis ground (-):</i>	Is the voltage less than 3 V?	Go to step 8 .	Repair the wiring harness.
8 CHECK GROUND CIRCUIT OF ABSCM&H/U. 1) Turn the ignition switch to OFF. 2) Disconnect the connector from ABSCM&H/U. 3) Measure the resistance between ABSCM&H/U and chassis ground. <i>Connector & terminal</i> <i>LHD: (B301) No. 23 — Chassis ground:</i> <i>RHD: (F49) No. 23 — Chassis ground:</i>	Is the resistance less than 0.5 Ω ?	Go to step 9 .	Repair the ABSCM&H/U ground harness.
9 CHECK WIRING HARNESS. Measure the resistance between connector (B37) or (F45) and chassis ground. <i>Connector & terminal</i> <i>LHD: (B37) No. 23 — Chassis ground:</i> <i>RHD: (F45) No. 13 — Chassis ground:</i>	Is the resistance less than 0.5 Ω ?	Go to step 10 .	Repair the harness connector.
10 CHECK POOR CONTACT IN CONNECTORS. Turn the ignition switch to OFF.	Is there poor contact in connectors between combination meter and ABSCM&H/U?	Repair the connector.	Replace the ABSCM only. <Ref. to ABS-8, ABSCM (ABS CONTROL MODULE), REPLACE, ABS Control Module and Hydraulic Control Unit (ABSCM&H/U).>

Diagnostics Procedure without Diagnostic Trouble Code (DTC)

ABS (DIAGNOSTIC)

- RHD model

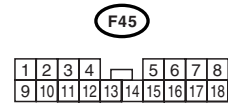
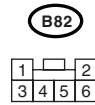
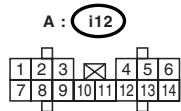
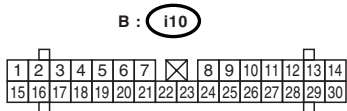
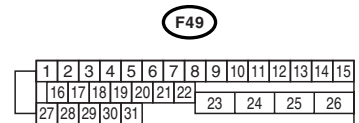
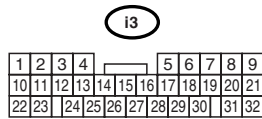
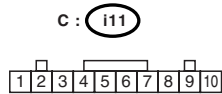
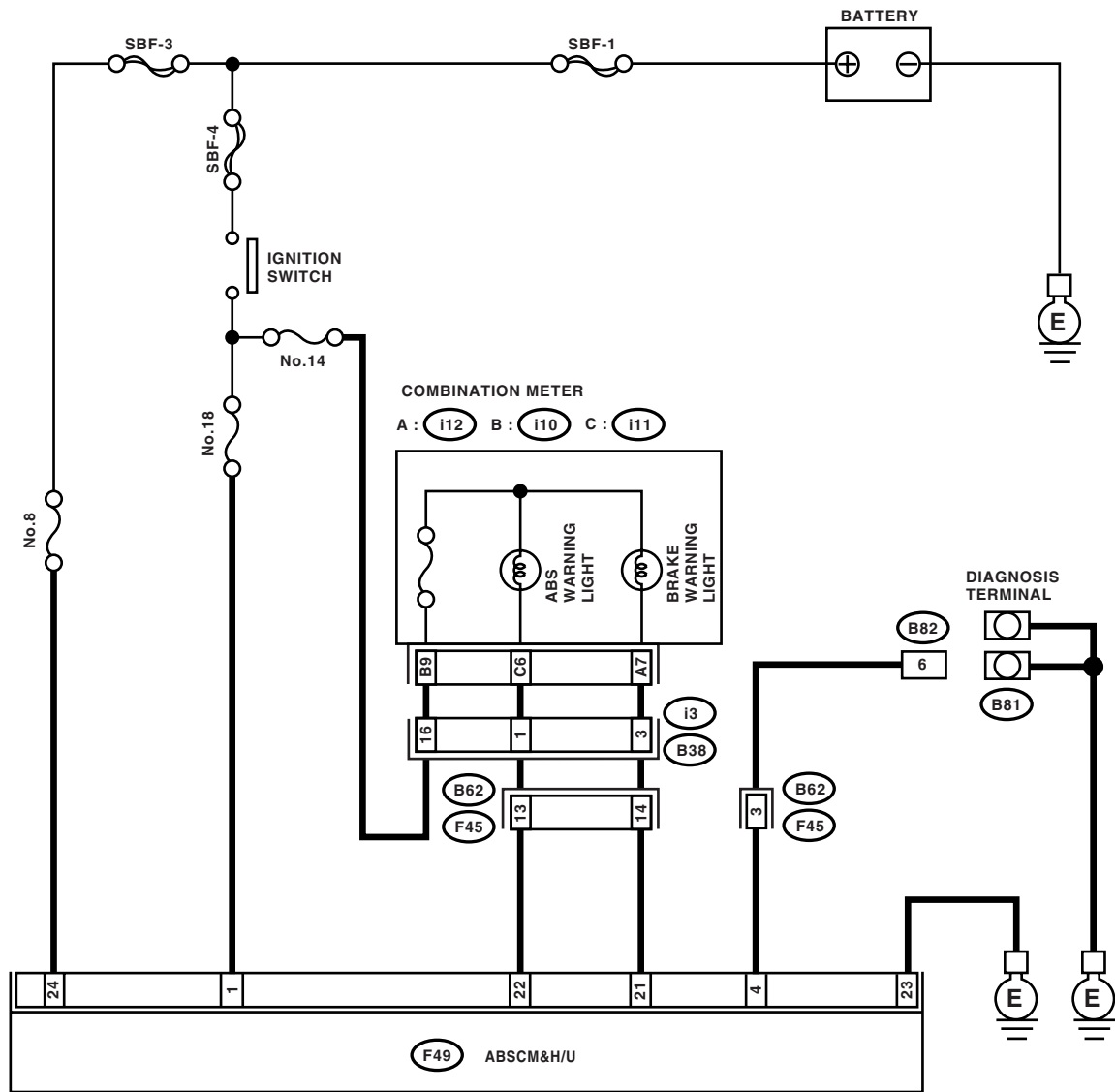

ABS00452

Diagnostics Procedure without Diagnostic Trouble Code (DTC)

ABS (DIAGNOSTIC)

Step	Check	Yes	No
1 CHECK INSTALLATION OF ABSCM&H/U CONNECTOR. Turn the ignition switch to OFF.	Is the ABSCM&H/U connector inserted into ABSCM until the clamp locks onto it?	Go to step 2.	Insert the ABSCM&H/U connector into ABSCM&H/U until the clamp locks onto it.
2 CHECK GROUND TERMINAL. Measure the resistance between ground terminals (B81) and chassis ground. <i>Terminals</i> <i>Ground terminal (A) — Chassis ground:</i> <i>Ground terminal (B) — Chassis ground:</i>	Is the resistance less than 0.5 Ω ?	Go to step 3.	Repair the ground terminal harness.
3 CHECK DIAGNOSIS LINE. 1) Connect the ground terminal (B81) to diagnosis connector (B82) No. 6. 2) Disconnect the connector from ABSCM&H/U. 3) Measure the resistance between ABSCM&H/U connector and chassis ground. <i>Connector & terminal</i> <i>LHD: (B301) No. 4 — Chassis ground:</i> <i>RHD: (F49) No. 4 — Chassis ground:</i>	Is the resistance less than 0.5 Ω ?	Go to step 4.	Repair the harness connector between ABSCM&H/U and diagnosis connector.
4 CHECK GENERATOR. 1) Start the engine. 2) Idle the engine. 3) Measure the voltage between generator and chassis ground. <i>Terminal</i> <i>Generator B terminal (+) — Chassis ground (-):</i>	Is the voltage 10 — 15 V?	Go to step 5.	Repair the generator. <Ref. to SC(H4SO)-15, Generator.>
5 CHECK BATTERY TERMINAL. Turn the ignition switch to OFF.	Is there poor contact at battery terminal?	Repair or tighten the battery terminal.	Go to step 6.
6 CHECK POWER SUPPLY OF ABSCM. 1) Start the engine. 2) Idle the engine. 3) Measure the voltage between ABSCM&H/U connector and chassis ground. <i>Connector & terminal</i> <i>LHD: (B301) No. 1 (+) — Chassis ground (-):</i> <i>RHD: (F49) No. 1 (+) — Chassis ground (-):</i>	Is the voltage 10 — 15 V?	Go to step 7.	Repair the ABSCM&H/U power supply circuit.
7 CHECK WIRING HARNESS. 1) Disconnect the connector (i2) or (B62) from connector (B37) or (F45). 2) Turn ignition switch to ON.	Does the ABS warning light come on?	Repair the front or body wiring harness.	Go to step 8.
8 CHECK TERMINAL AT ABSCM&H/U. 1) Turn the ignition switch to OFF. 2) Check for damage at the ABSCM&H/U terminal.	Is there damage on terminal?	Replace the ABSCM&H/U. <Ref. to ABS-7, ABS Control Module and Hydraulic Control Unit (ABSCM&H/U).>	Go to step 9.

Diagnostics Procedure without Diagnostic Trouble Code (DTC)

ABS (DIAGNOSTIC)

Step	Check	Yes	No
9 CHECK ABSCM&H/U. Measure the resistance between ABSCM&H/U terminals. <i>Terminal</i> <i>No. 22 — No. 23:</i>	Is the resistance more than 1 M Ω ?	Go to step 10.	Replace the ABSCM only. <Ref. to ABS-8, ABSCM (ABS CONTROL MODULE), REPLACE, ABS Control Module and Hydraulic Control Unit (ABSCM&H/U).>
10 CHECK WIRING HARNESS. Measure the resistance between connector (B36) or (F45) and chassis ground. <i>Connector & terminal</i> <i>LHD: (B37) No. 23 — Chassis ground:</i> <i>RHD: (F45) No. 13 — Chassis ground:</i>	Is the resistance less than 0.5 Ω ?	Go to step 11.	Repair the harness.
11 CHECK WIRING HARNESS. 1) Connect the connector to ABSCM&H/U. 2) Measure the resistance between connector (B36) or (F45) and chassis ground. <i>Connector & terminal</i> <i>LHD: (B37) No. 23 — Chassis ground:</i> <i>RHD: (F45) No. 13 — Chassis ground:</i>	Is the resistance more than 1 M Ω ?	Go to step 12.	Repair the harness.
12 CHECK POOR CONTACT IN ABSCM&H/U CONNECTOR.	Is there poor contact in ABSCM&H/U connector?	Repair the connector.	Replace the ABSCM only. <Ref. to ABS-8, ABSCM (ABS CONTROL MODULE), REPLACE, ABS Control Module and Hydraulic Control Unit (ABSCM&H/U).>

Diagnostics Procedure without Diagnostic Trouble Code (DTC)

ABS (DIAGNOSTIC)

C: ABS AND BRAKE WARNING LIGHT DO NOT GO OFF.

DIAGNOSIS:

- ABS warning light circuit is open or shorted.
- Brake warning light circuit is shorted.
- Faulty sensor/connector

TROUBLE SYMPTOM:

- When starting the engine, ABS warning light is kept ON.
- After starting the engine, brake warning light is kept ON, even if the parking brake lever has been released.

Diagnostics Procedure without Diagnostic Trouble Code (DTC)

ABS (DIAGNOSTIC)

WIRING DIAGRAM:

- LHD model

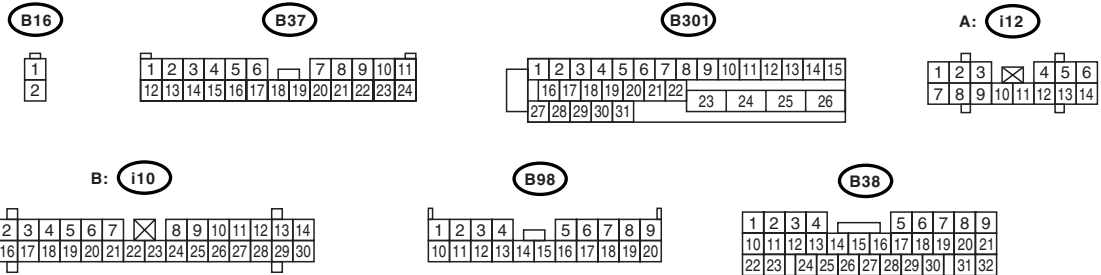
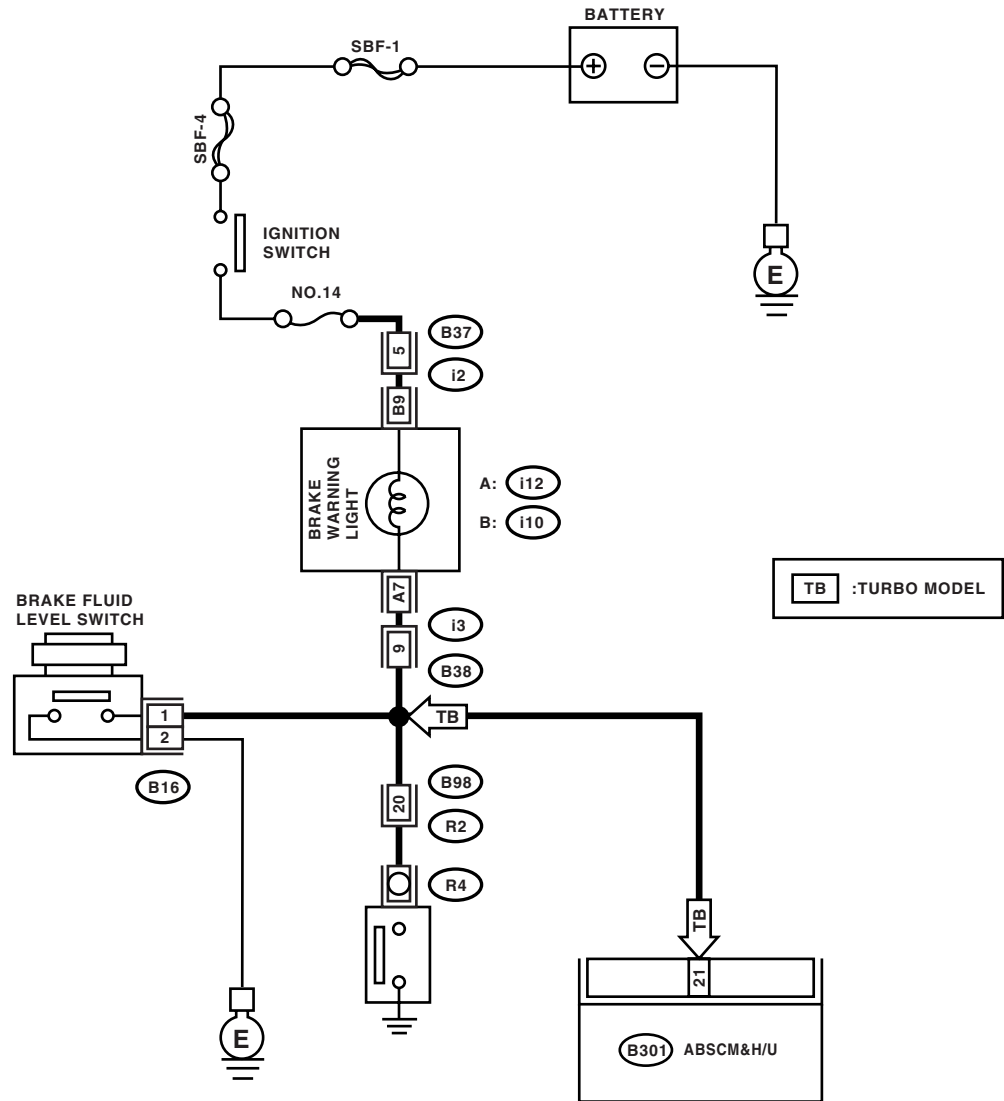

ABS00453

Diagnostics Procedure without Diagnostic Trouble Code (DTC)

ABS (DIAGNOSTIC)

- RHD model

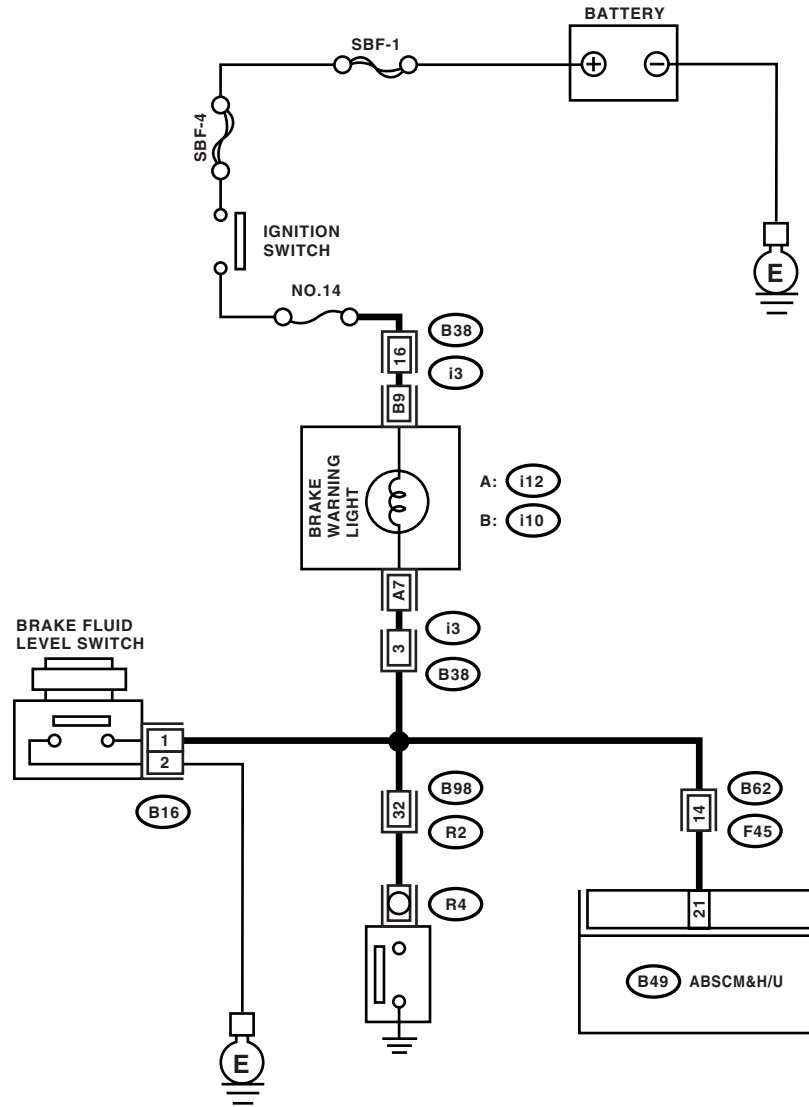

B16



B36

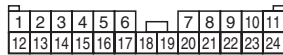

B301

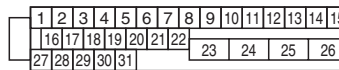

F45

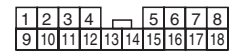

A: i12

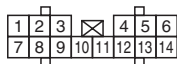

B: i10

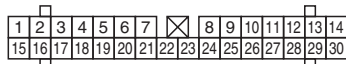

B98 i3

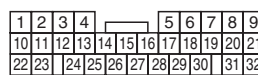

ABS00214

Diagnostics Procedure without Diagnostic Trouble Code (DTC)

ABS (DIAGNOSTIC)

Step	Check	Yes	No
1 CHECK BRAKE FLUID AMOUNT. Check the amount of brake fluid in reservoir tank of master cylinder.	Is the brake fluid amount between "MAX" line and "MIN" line?	Go to step 2.	Fill the brake fluid to specified amount.
2 CHECK BRAKE FLUID LEVEL SWITCH. 1) Disconnect the level switch connector (B16) from master cylinder. 2) Measure the resistance of master cylinder terminals. <i>Terminals</i> <i>No. 1 — No. 2:</i>	Is the resistance more than 1 MΩ?	Go to step 3.	Replace the master cylinder.
3 CHECK PARKING BRAKE SWITCH. 1) Disconnect the connector (R4) from parking brake switch. 2) Release the parking brake. 3) Measure the resistance between parking brake switch terminal and chassis ground.	Is the resistance more than 1 MΩ?	Go to step 4.	Replace the parking brake switch.
4 CHECK GROUND SHORT OF HARNESS. 1) Disconnect the connector from ABSCM&H/U. 2) Disconnect the connector (i12) from combination meter. 3) Turn the ignition switch to ON.	Does the brake warning light go off?	Go to step 5.	Repair the harness.
5 CHECK POOR CONTACT IN ABSCM&H/U.	Is there poor contact in ABSCM&H/U connector?	Repair the connector.	Replace the ABSCM only. <Ref. to ABS-8, ABSCM (ABS CONTROL MODULE), REPLACE, ABS Control Module and Hydraulic Control Unit (ABSCM&H/U).>

Diagnostics Procedure without Diagnostic Trouble Code (DTC)

ABS (DIAGNOSTIC)

D: TROUBLE CODE DOES NOT APPEAR.

DIAGNOSIS:

Diagnosis circuit is open.

TROUBLE SYMPTOM:

The ABS warning light turns on or off normally but the start code cannot be read out in diagnostic mode.

WIRING DIAGRAM:

- LHD model

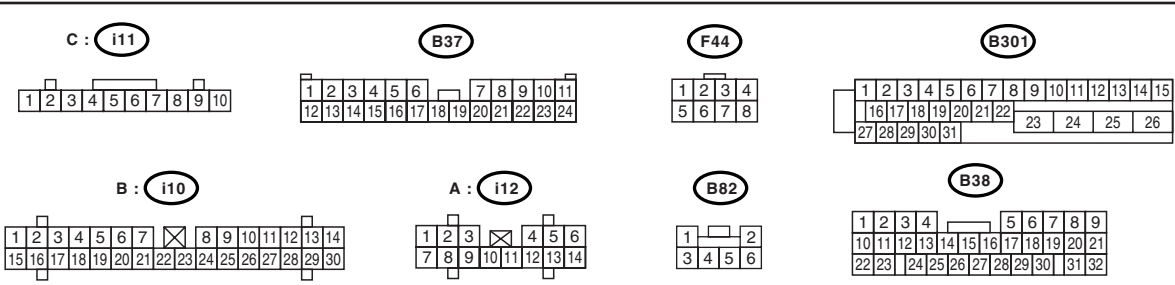
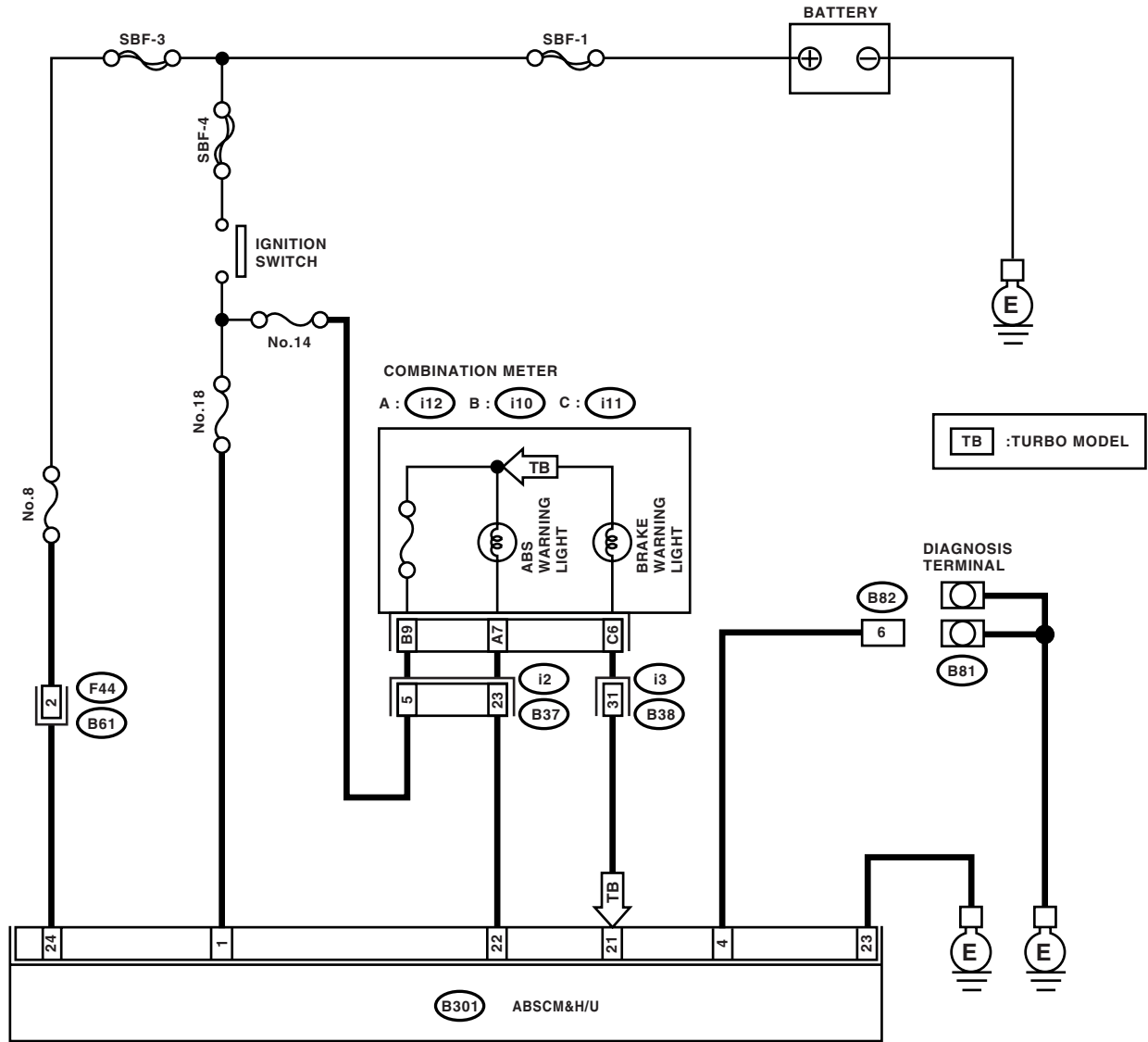

ABS00451

Diagnostics Procedure without Diagnostic Trouble Code (DTC)

ABS (DIAGNOSTIC)

- RHD model

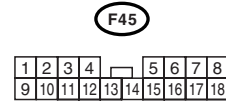
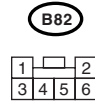
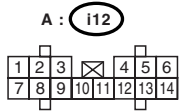
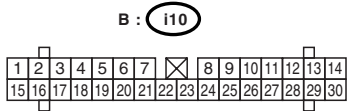
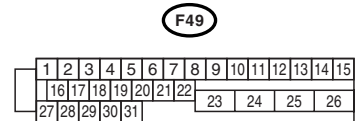
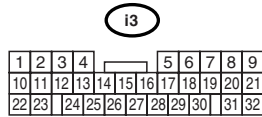
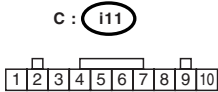
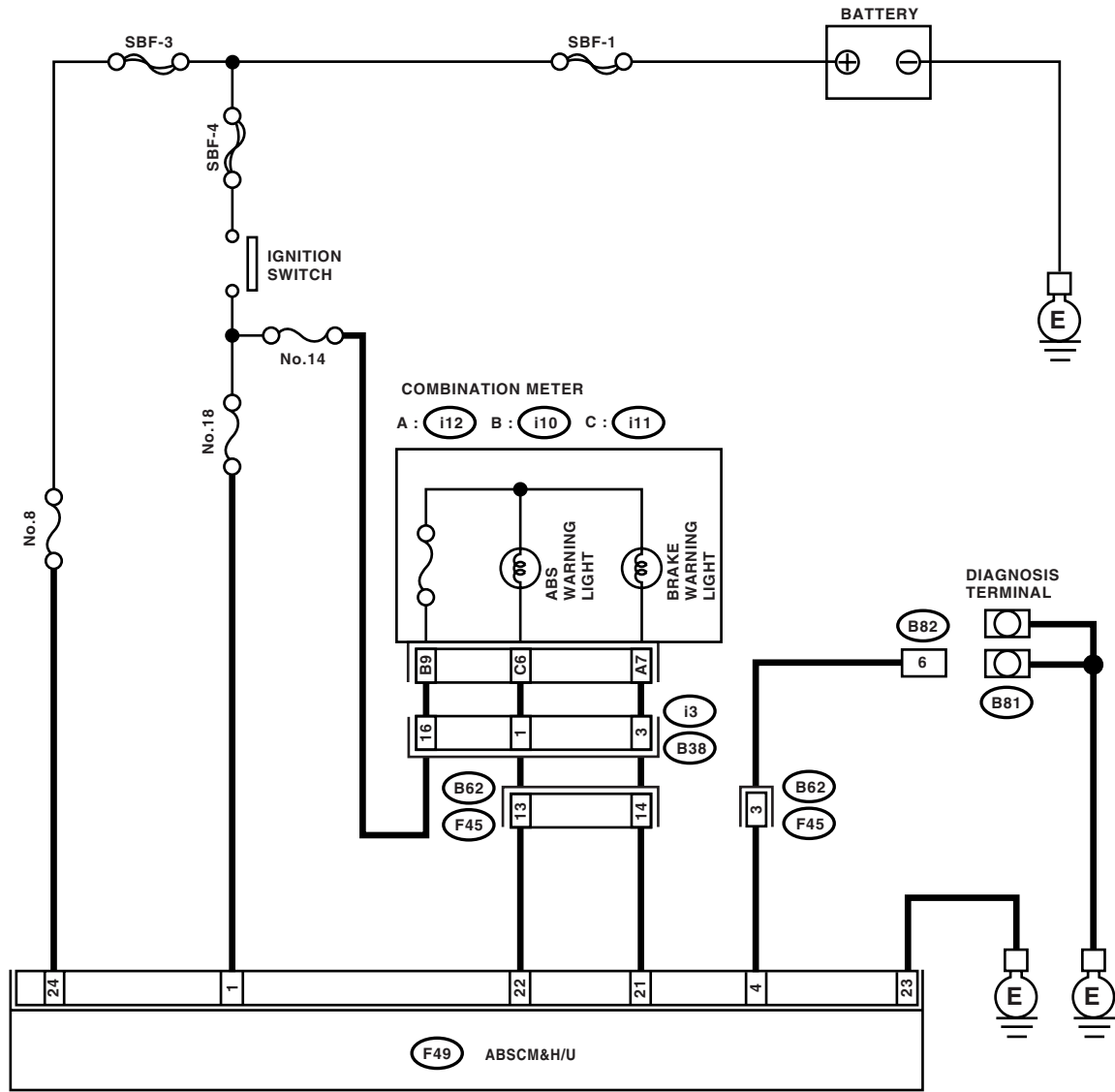

ABS00452

Diagnostics Procedure without Diagnostic Trouble Code (DTC)

ABS (DIAGNOSTIC)

Step	Check	Yes	No
1 CHECK GROUND TERMINAL. 1) Turn the ignition switch to OFF. 2) Measure the resistance between ground terminals (B81) and chassis ground. Terminals <i>Ground terminal (A) — Chassis ground:</i> <i>Ground terminal (B) — Chassis ground:</i>	Is the resistance less than 0.5 Ω ?	Go to step 2.	Repair the ground terminal harness.
2 CHECK DIAGNOSIS LINE. 1) Connect the diagnosis terminal (B81) to diagnosis connector (B82) No. 6. 2) Disconnect the connector from ABSCM&H/U. 3) Measure the resistance between ABSCM&H/U connector and chassis ground. Connector & terminal <i>LHD: (B301) No. 4 — Chassis ground:</i> <i>RHD: (F49) No. 4 — Chassis ground:</i>	Is the resistance less than 0.5 Ω ?	Go to step 3.	Repair the harness connector between ABSCM&H/U and ground connector.
3 CHECK POOR CONTACT IN ABSCM&H/U CONNECTOR.	Is there poor contact in ABSCM&H/U connector?	Repair the connector.	Replace the ABSCM only. <Ref. to ABS-8, ABSCM (ABS CONTROL MODULE), REPLACE, ABS Control Module and Hydraulic Control Unit (ABSCM&H/U).>

E: DTC 21 ABNORMAL ABS SENSOR (OPEN CIRCUIT OR INPUT VOLTAGE TOO HIGH) (FRONT RH)

NOTE:

For the diagnostic procedure, refer to DTC 27. <Ref. to ABS-46, DTC 27 ABNORMAL ABS SENSOR (OPEN CIRCUIT OR INPUT VOLTAGE TOO HIGH) (REAR LH), Diagnostics Procedure without Diagnostic Trouble Code (DTC).>

F: DTC 23 ABNORMAL ABS SENSOR (OPEN CIRCUIT OR INPUT VOLTAGE TOO HIGH) (FRONT LH)

NOTE:

For the diagnostic procedure, refer to DTC 27. <Ref. to ABS-46, DTC 27 ABNORMAL ABS SENSOR (OPEN CIRCUIT OR INPUT VOLTAGE TOO HIGH) (REAR LH), Diagnostics Procedure without Diagnostic Trouble Code (DTC).>

G: DTC 25 ABNORMAL ABS SENSOR (OPEN CIRCUIT OR INPUT VOLTAGE TOO HIGH) (REAR RH)

NOTE:

For the diagnostic procedure, refer to DTC 27. <Ref. to ABS-46, DTC 27 ABNORMAL ABS SENSOR (OPEN CIRCUIT OR INPUT VOLTAGE TOO HIGH) (REAR LH), Diagnostics Procedure without Diagnostic Trouble Code (DTC).>

Diagnostics Procedure without Diagnostic Trouble Code (DTC)

ABS (DIAGNOSTIC)

H: DTC 27 ABNORMAL ABS SENSOR (OPEN CIRCUIT OR INPUT VOLTAGE TOO HIGH) (REAR LH)

DIAGNOSIS:

- Faulty ABS wheel speed sensor (Broken harness, input voltage too high)
- Faulty harness connector

TROUBLE SYMPTOM:

ABS does not operate.

Diagnostics Procedure without Diagnostic Trouble Code (DTC)

ABS (DIAGNOSTIC)

WIRING DIAGRAM:

- LHD model

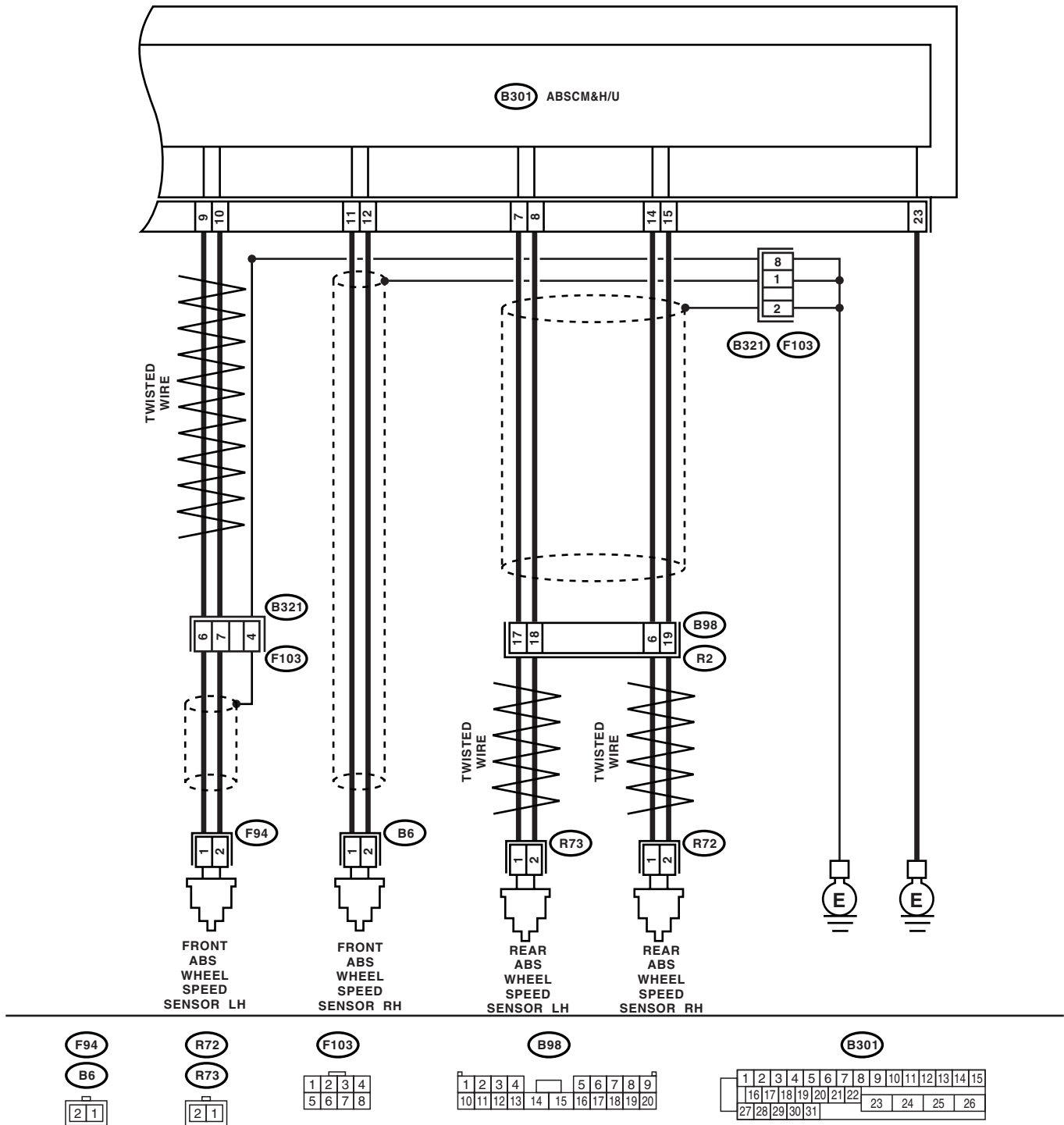

ABS00454

Diagnostics Procedure without Diagnostic Trouble Code (DTC)

ABS (DIAGNOSTIC)

- RHD model

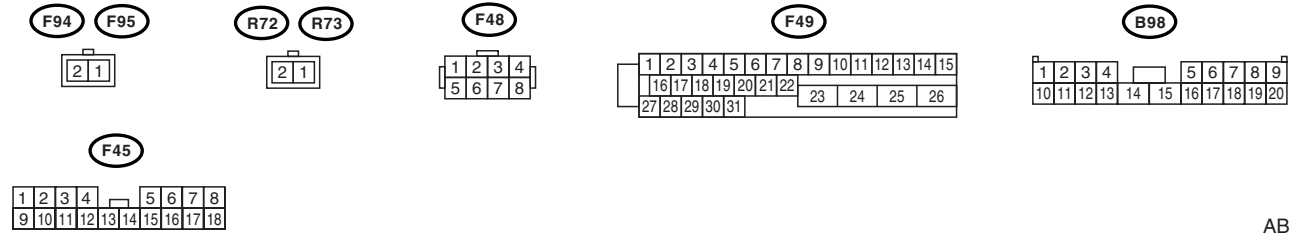
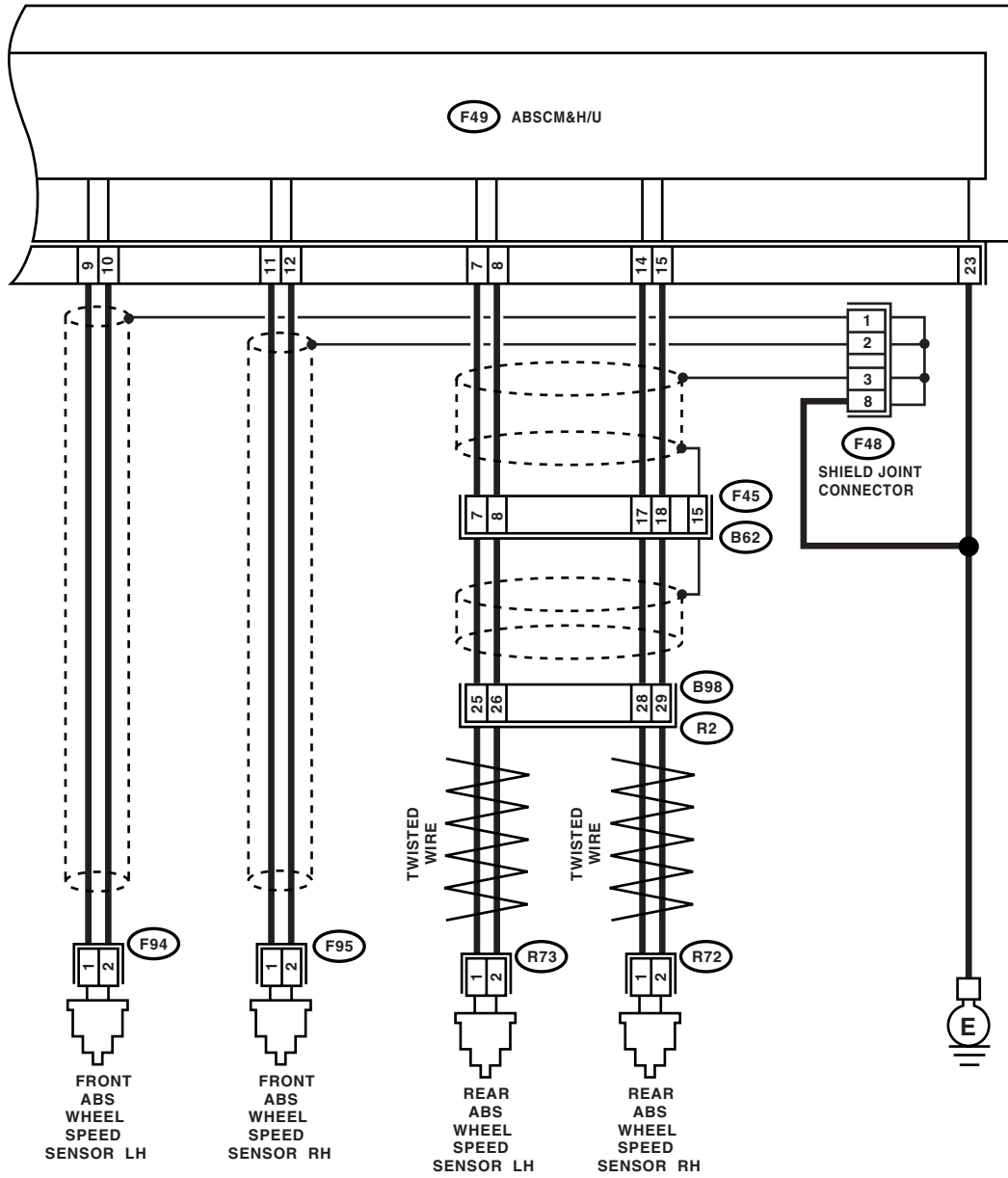

ABS00467

Diagnostics Procedure without Diagnostic Trouble Code (DTC)

ABS (DIAGNOSTIC)

Step	Check	Yes	No
<p>1 CHECK ABS WHEEL SPEED SENSOR.</p> <p>1) Turn the ignition switch to OFF.</p> <p>2) Disconnect the connector from ABS wheel speed sensor.</p> <p>3) Measure the resistance of ABS wheel speed sensor connector terminals while shaking the harness lightly.</p> <p>Terminal</p> <p>Front RH No. 1 — No. 2:</p> <p>Front LH No. 1 — No. 2:</p> <p>Rear RH No. 1 — No. 2:</p> <p>Rear LH No. 1 — No. 2:</p>	<p>Is the resistance the following value?</p> <p>Front: 1 — 1.5 kΩ</p> <p>Rear: 1.025 — 1.265 kΩ</p>	Go to step 2.	<p>Replace the ABS wheel speed sensor. Front: <Ref. to ABS-15, Front ABS Wheel Speed Sensor.> Rear: <Ref. to ABS-18, Rear ABS Wheel Speed Sensor.></p>
<p>2 CHECK BATTERY SHORT OF ABS WHEEL SPEED SENSOR.</p> <p>1) Disconnect the connector from ABSCM&H/U.</p> <p>2) Measure the voltage between ABS wheel speed sensor and chassis ground.</p> <p>Terminal</p> <p>Front RH No. 1 (+) — Chassis ground (-):</p> <p>Front LH No. 1 (+) — Chassis ground (-):</p> <p>Rear RH No. 1 (+) — Chassis ground (-):</p> <p>Rear LH No. 1 (+) — Chassis ground (-):</p>	Is the voltage less than 1 V?	Go to step 3.	<p>Replace the ABS wheel speed sensor. Front: <Ref. to ABS-15, Front ABS Wheel Speed Sensor.> Rear: <Ref. to ABS-18, Rear ABS Wheel Speed Sensor.></p>
<p>3 CHECK BATTERY SHORT OF ABS WHEEL SPEED SENSOR.</p> <p>1) Turn the ignition switch to ON.</p> <p>2) Measure the voltage between ABS wheel speed sensor and chassis ground.</p> <p>Terminal</p> <p>Front RH No. 1 (+) — Chassis ground (-):</p> <p>Front LH No. 1 (+) — Chassis ground (-):</p> <p>Rear RH No. 1 (+) — Chassis ground (-):</p> <p>Rear LH No. 1 (+) — Chassis ground (-):</p>	Is the voltage less than 1 V?	Go to step 4.	<p>Replace the ABS wheel speed sensor. Front: <Ref. to ABS-15, Front ABS Wheel Speed Sensor.> Rear: <Ref. to ABS-18, Rear ABS Wheel Speed Sensor.></p>
<p>4 CHECK HARNESS CONNECTOR BETWEEN ABSCM&H/U AND ABS WHEEL SPEED SENSOR.</p> <p>1) Turn the ignition switch to OFF.</p> <p>2) Connect the connector to ABS wheel speed sensor.</p> <p>3) Measure the resistance between ABSCM&H/U connector terminals.</p> <p>Connector & terminal</p> <p>DTC 21</p> <p>LHD: (B301) No. 11 — No. 12:</p> <p>RHD: (F49) No. 11 — No. 12:</p> <p>DTC 23</p> <p>LHD: (B301) No. 9 — No. 10:</p> <p>RHD: (F49) No. 9 — No. 10:</p> <p>DTC 25</p> <p>LHD: (B301) No. 14 — No. 15:</p> <p>RHD: (F49) No. 14 — No. 15:</p> <p>DTC 27</p> <p>LHD: (B301) No. 7 — No. 8:</p> <p>RHD: (F49) No. 7 — No. 8:</p>	<p>Is the resistance the following value?</p> <p>Front: 1 — 1.5 kΩ</p> <p>Rear: 1.025 — 1.265 kΩ</p>	Go to step 5.	<p>Repair the harness connector between ABSCM&H/U and ABS wheel speed sensor.</p>

Diagnostics Procedure without Diagnostic Trouble Code (DTC)

ABS (DIAGNOSTIC)

Step	Check	Yes	No
<p>5</p> <p>CHECK BATTERY SHORT OF HARNESS. Measure the voltage between ABSCM&H/U connector and chassis ground. Connector & terminal DTC 21 LHD:(B301) No. 11 (+) — Chassis ground (-): RHD: (F49) No. 11 (+) — Chassis ground (-): DTC 23 LHD: (B301) No. 9 (+) — Chassis ground (-): RHD: (F49) No. 9 (+) — Chassis ground (-): DTC 25 LHD:(B301) No. 14 (+) — Chassis ground (-): RHD: (F49) No. 14 (+) — Chassis ground (-): DTC 27 LHD: (B301) No. 7 (+) — Chassis ground (-): RHD: (F49) No. 7 (+) — Chassis ground (-):</p>	<p>Is the voltage less than 1 V?</p>	<p>Go to step 6.</p>	<p>Repair the harness between ABSCM&H/U and ABS wheel speed sensor.</p>
<p>6</p> <p>CHECK BATTERY SHORT OF HARNESS. 1) Turn the ignition switch to ON. 2) Measure the voltage between ABSCM&H/U connector and chassis ground. Connector & terminal DTC 21 LHD:(B301) No. 11 (+) — Chassis ground (-): RHD: (F49) No. 11 (+) — Chassis ground (-): DTC 23 LHD: (B301) No. 9 (+) — Chassis ground (-): RHD: (F49) No. 9 (+) — Chassis ground (-): DTC 25 LHD:(B301) No. 14 (+) — Chassis ground (-): RHD: (F49) No. 14 (+) — Chassis ground (-): DTC 27 LHD: (B301) No. 7 (+) — Chassis ground (-): RHD: (F49) No. 7 (+) — Chassis ground (-):</p>	<p>Is the voltage less than 1 V?</p>	<p>Go to step 7.</p>	<p>Repair the harness between ABSCM&H/U and ABS wheel speed sensor.</p>
<p>7</p> <p>CHECK INSTALLATION OF ABS WHEEL SPEED SENSOR. Turn the ignition switch to OFF.</p>	<p>Are the ABS wheel speed sensor installation bolts tightened 33 N·m (3.4 kgf·m, 24.6 ft·lb)?</p>	<p>Go to step 8.</p>	<p>Tighten the ABS wheel speed sensor installation bolts securely.</p>

Diagnostics Procedure without Diagnostic Trouble Code (DTC)

ABS (DIAGNOSTIC)

Step	Check	Yes	No
8 CHECK ABS WHEEL SPEED SENSOR GAP. Measure the gap between ABS wheel speed sensor piece and tone wheel.	Is the gap the following value? Front wheel: 0.3 — 0.8 mm (0.012 — 0.031 in) Rear wheel: 0.7 — 1.2 mm (0.028 — 0.047 in)	Go to step 9.	Adjust the gap. NOTE: Adjust the gap using spacers (Part No. 26755AA000). If the spacers cannot correct gap, replace worn ABS wheel speed sensor or worn tone wheel.
9 CHECK TONE WHEEL RUNOUT. Measure the tone wheel runout.	Is the runout less than 0.05 mm (0.0020 in)?	Go to step 10.	Replace the tone wheel. Front: <Ref. to ABS-21, Front Tone Wheel.> Rear: <Ref. to ABS-22, Rear Tone Wheel.>
10 CHECK GROUND SHORT OF ABS WHEEL SPEED SENSOR. 1) Turn the ignition switch to ON. 2) Measure the resistance between ABS wheel speed sensor and chassis ground. <i>Terminal</i> <i>Front RH No. 1 — Chassis ground:</i> <i>Front LH No. 1 — Chassis ground:</i> <i>Rear RH No. 1 — Chassis ground:</i> <i>Rear LH No. 1 — Chassis ground:</i>	Is the resistance more than 1 MΩ?	Go to step 11.	Replace ABSCM only and the ABS wheel speed sensor. <Ref. to ABS-8, ABSCM (ABS CONTROL MODULE), REPLACE, ABS Control Module and Hydraulic Control Unit (ABSCM&H/U).> Front: <Ref. to ABS-15, Front ABS Wheel Speed Sensor.> Rear: <Ref. to ABS-18, Rear ABS Wheel Speed Sensor.>
11 CHECK GROUND SHORT OF HARNESS. 1) Turn the ignition switch to OFF. 2) Connect the connector to ABS wheel speed sensor. 3) Measure the resistance between ABSCM&H/U connector terminal and chassis ground. <i>Connector & terminal</i> <i>DTC 21</i> <i>LHD: (B301) No. 11 — Chassis ground:</i> <i>RHD: (F49) No. 11 — Chassis ground:</i> <i>DTC 23</i> <i>LHD: (B301) No. 9 — Chassis ground:</i> <i>RHD: (F49) No. 9 — Chassis ground:</i> <i>DTC 25</i> <i>LHD: (B301) No. 14 — Chassis ground:</i> <i>RHD: (F49) No. 14 — Chassis ground:</i> <i>DTC 27</i> <i>LHD: (B301) No. 7 — Chassis ground:</i> <i>RHD: (F49) No. 7 — Chassis ground:</i>	Is the resistance more than 1 MΩ?	Go to step 12.	Repair the harness between ABSCM&H/U and ABS wheel speed sensor. Replace the ABSCM only. <Ref. to ABS-8, ABSCM (ABS CONTROL MODULE), REPLACE, ABS Control Module and Hydraulic Control Unit (ABSCM&H/U).>
12 CHECK POOR CONTACT IN CONNECTORS.	Is there poor contact in connectors between ABSCM&H/U and ABS wheel speed sensor?	Repair the connector.	Go to step 13.

Diagnostics Procedure without Diagnostic Trouble Code (DTC)

ABS (DIAGNOSTIC)

Step	Check	Yes	No
13 CHECK ABSCM&H/U. 1) Connect all connectors. 2) Erase the memory. 3) Perform the inspection mode. 4) Read out the DTC.	Is the same DTC as in current diagnosis still being output?	Replace the ABSCM only. <Ref. to ABS-8, ABSCM (ABS CONTROL MODULE), REPLACE, ABS Control Module and Hydraulic Control Unit (ABSCM&H/U).>	Go to step 14 .
14 CHECK ANY OTHER DTC APPEARANCE.	Are other DTCs being output?	Proceed with the diagnosis corresponding to the DTC.	A temporary poor contact. NOTE: Check the harness and connectors between ABSCM&H/U and ABS wheel speed sensor.

**I: DTC 22 ABNORMAL ABS SENSOR (ABNORMAL ABS SENSOR SIGNAL)
(FRONT RH)**

NOTE:

For the diagnostic procedure, refer to DTC 28. <Ref. to ABS-54, DTC 28 ABNORMAL ABS SENSOR (ABNORMAL ABS SENSOR SIGNAL) (REAR LH), Diagnostics Procedure without Diagnostic Trouble Code (DTC).>

**J: DTC 24 ABNORMAL ABS SENSOR (ABNORMAL ABS SENSOR SIGNAL)
(FRONT LH)**

NOTE:

For the diagnostic procedure, refer to DTC 28. <Ref. to ABS-54, DTC 28 ABNORMAL ABS SENSOR (ABNORMAL ABS SENSOR SIGNAL) (REAR LH), Diagnostics Procedure without Diagnostic Trouble Code (DTC).>

**K: DTC 26 ABNORMAL ABS SENSOR (ABNORMAL ABS SENSOR SIGNAL)
(REAR RH)**

NOTE:

For the diagnostic procedure, refer to DTC 28. <Ref. to ABS-54, DTC 28 ABNORMAL ABS SENSOR (ABNORMAL ABS SENSOR SIGNAL) (REAR LH), Diagnostics Procedure without Diagnostic Trouble Code (DTC).>

Diagnostics Procedure without Diagnostic Trouble Code (DTC)

ABS (DIAGNOSTIC)

L: DTC 28 ABNORMAL ABS SENSOR (ABNORMAL ABS SENSOR SIGNAL) (REAR LH)

DIAGNOSIS:

- Faulty ABS wheel speed sensor signal (noise, irregular signal, etc.)
- Faulty harness connector

TROUBLE SYMPTOM:

ABS does not operate.

Diagnostics Procedure without Diagnostic Trouble Code (DTC)

ABS (DIAGNOSTIC)

WIRING DIAGRAM:

- LHD model

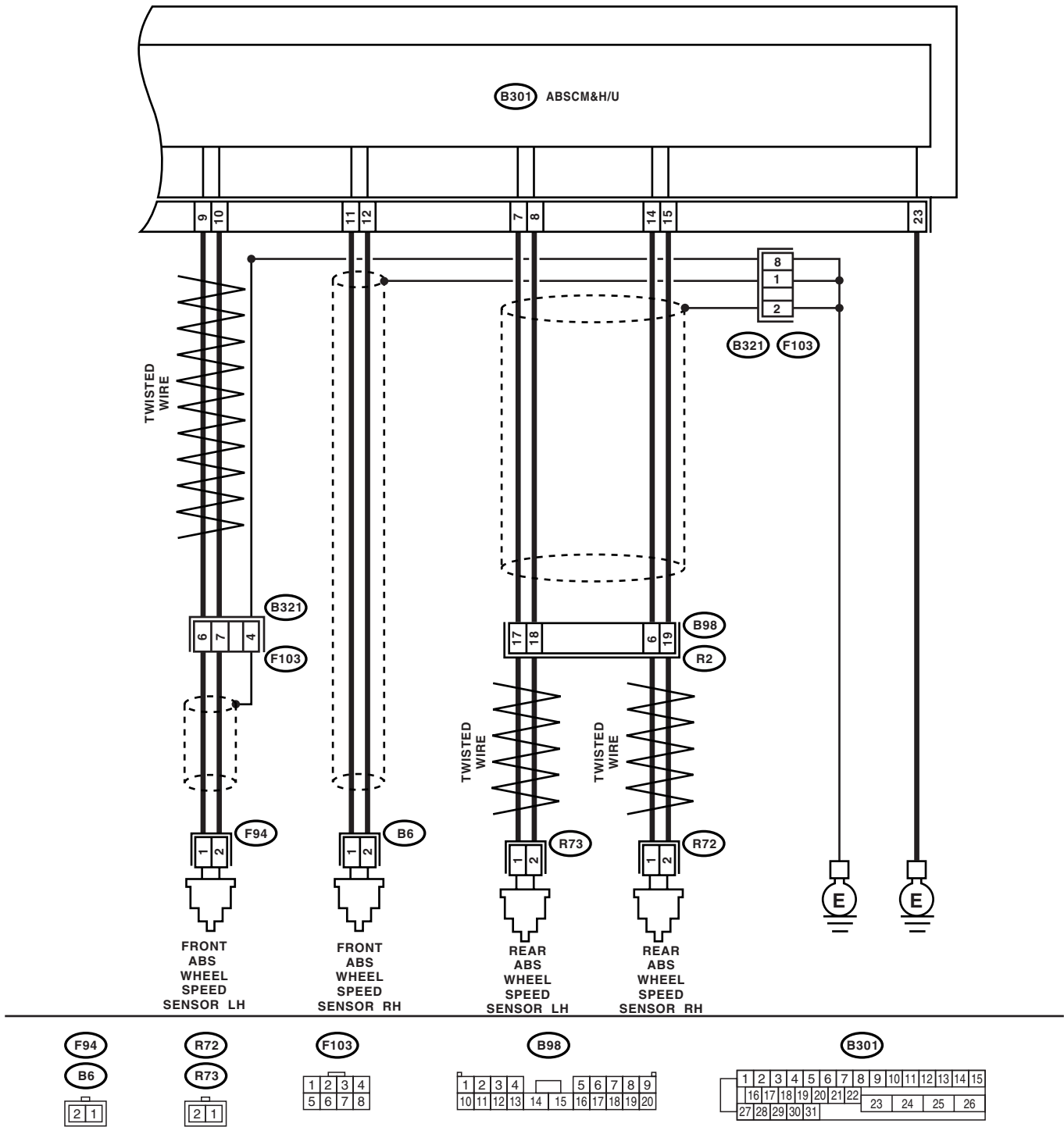

ABS00454

Diagnostics Procedure without Diagnostic Trouble Code (DTC)

ABS (DIAGNOSTIC)

- RHD model

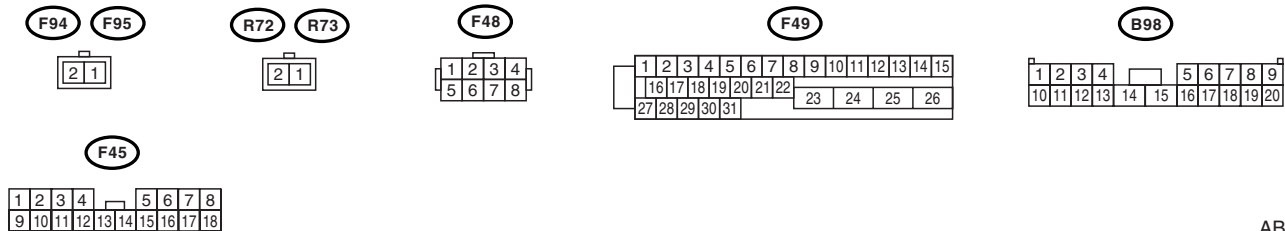
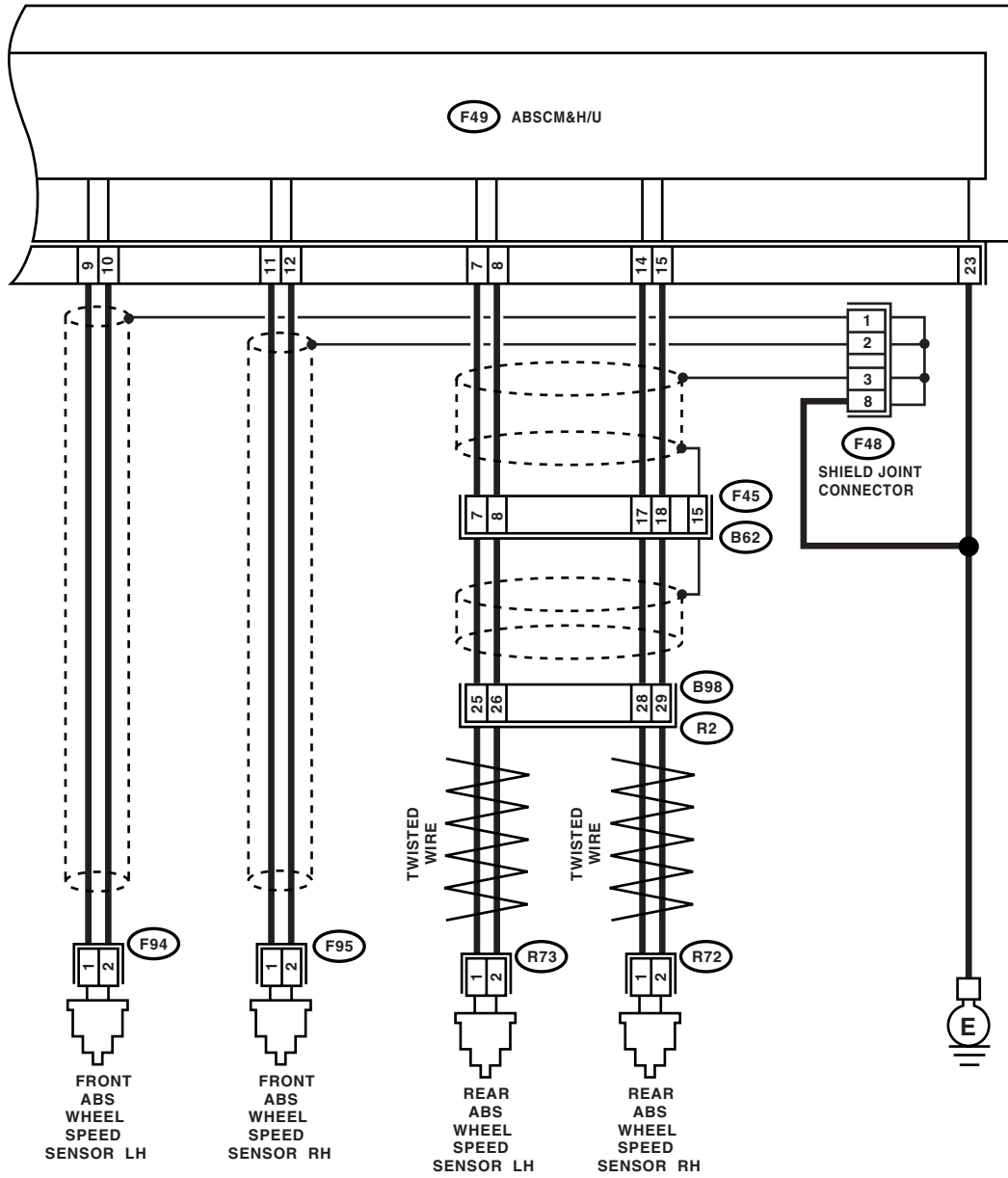

ABS00467

Diagnostics Procedure without Diagnostic Trouble Code (DTC)

ABS (DIAGNOSTIC)

Step	Check	Yes	No
1 CHECK INSTALLATION OF ABS WHEEL SPEED SENSOR. Turn the ignition switch to OFF.	Are the ABS wheel speed sensor installation bolts tightened 33 N·m (3.4 kgf-m, 24.6 ft-lb)?	Go to step 2.	Tighten the ABS wheel speed sensor installation bolts securely.
2 CHECK ABS WHEEL SPEED SENSOR GAP. Measure the gap between ABS wheel speed sensor piece and tone wheel.	Is the gap the following value? Front wheel: 0.3 — 0.8 mm (0.012 — 0.031 in) Rear wheel: 0.7 — 1.2 mm (0.028 — 0.047 in)	Go to step 3.	Adjust the gap. NOTE: Adjust the gap using spacer (Part No. 26755AA000). If the spacer cannot correct gap, replace worn ABS wheel speed sensor or worn tone wheel.
3 PREPARE OSCILLOSCOPE.	Is an oscilloscope available?	Go to step 4.	Go to step 5.
4 CHECK ABS WHEEL SPEED SENSOR SIGNAL. 1) Lift-up the vehicle. 2) Turn the ignition switch to OFF. 3) Connect the oscilloscope to the connector. 4) Turn the ignition switch to ON. 5) Rotate the wheels and measure voltage at specified frequency. <Ref. to ABS-17, WAVEFORM, Control Module I/O Signal.> NOTE: When this inspection is completed, the ABSCM sometimes stores DTC 29 or DTC 56. Connector & terminal DTC 22 <i>LHD: (B6) No. 1 (+) — No. 2 (-):</i> <i>RHD: (F95) No. 1 (+) — No. 2 (-):</i> DTC 24 <i>LHD: (F103) No. 6 (+) — No. 7 (-):</i> <i>RHD: (F94) No. 1 (+) — No. 2 (-):</i> DTC 26 <i>LHD: (B98) No. 6 (+) — No. 19 (-):</i> <i>RHD: (B98) No. 28 (+) — No. 29 (-):</i> DTC 28 <i>LHD: (B98) No. 17 (+) — No. 18 (-):</i> <i>RHD: (B98) No. 25 (+) — No. 26 (-):</i>	Is an oscilloscope pattern smooth, as shown in the figure? <Ref. to ABS-17, WAVEFORM, Control Module I/O Signal.>	Go to step 8.	Go to step 7.
5 CHECK CONTAMINATION OF ABS WHEEL SPEED SENSOR OR TONE WHEEL. Remove the disc rotor or drum from hub in accordance with DTC.	Is the ABS wheel speed sensor piece or the tone wheel contaminated by dirt or other foreign matter?	Thoroughly remove dirt or other foreign matter.	Go to step 6.

Diagnostics Procedure without Diagnostic Trouble Code (DTC)

ABS (DIAGNOSTIC)

Step	Check	Yes	No
6	CHECK DAMAGE OF THE ABS WHEEL SPEED SENSOR OR THE TONE WHEEL.	Are there broken or damaged in the ABS wheel speed sensor piece or the tone wheel?	Replace the ABS wheel speed sensor or the tone wheel. Front: <Ref. to ABS-15, Front ABS Wheel Speed Sensor.> Rear: <Ref. to ABS-18, Rear ABS Wheel Speed Sensor.> Front: <Ref. to ABS-21, Front Tone Wheel.> Rear: <Ref. to ABS-22, Rear Tone Wheel.>
7	CHECK THE TONE WHEEL RUNOUT. Measure the tone wheel runout.	Is the runout less than 0.05 mm (0.0020 in)?	Go to step 8 . Replace the tone wheel. Front: <Ref. to ABS-21, Front Tone Wheel.> Rear: <Ref. to ABS-22, Rear Tone Wheel.>
8	CHECK RESISTANCE OF ABS WHEEL SPEED SENSOR. 1) Turn the ignition switch to OFF. 2) Disconnect the connector from ABS wheel speed sensor. 3) Measure the resistance between ABS wheel speed sensor connector terminals while shaking the harness lightly. Terminal Front RH No. 1 — No. 2: Front LH No. 1 — No. 2: Rear RH No. 1 — No. 2: Rear LH No. 1 — No. 2:	Is the resistance the following value? Front: 1 — 1.5 k Ω Rear: 1.025 — 1.265 k Ω	Go to step 9 . Replace the ABS wheel speed sensor. Front: <Ref. to ABS-15, Front ABS Wheel Speed Sensor.> Rear: <Ref. to ABS-18, Rear ABS Wheel Speed Sensor.>
9	CHECK GROUND SHORT OF ABS WHEEL SPEED SENSOR. Measure the resistance between ABS wheel speed sensor and chassis ground. Terminal Front RH No. 1 — Chassis ground: Front LH No. 1 — Chassis ground: Rear RH No. 1 — Chassis ground: Rear LH No. 1 — Chassis ground:	Is the resistance more than 1 M Ω ?	Go to step 10 . Replace the ABS wheel speed sensor. Front: <Ref. to ABS-15, Front ABS Wheel Speed Sensor.> Rear: <Ref. to ABS-18, Rear ABS Wheel Speed Sensor.>

Diagnostics Procedure without Diagnostic Trouble Code (DTC)

ABS (DIAGNOSTIC)

Step	Check	Yes	No
10 CHECK HARNESS CONNECTOR BETWEEN ABSCM&H/U AND ABS WHEEL SPEED SENSOR. 1) Connect the connector to ABS wheel speed sensor. 2) Disconnect the connector from ABSCM&H/U. 3) Measure the resistance at ABSCM&H/U connector terminals. <i>Connector & terminal</i> DTC 22 <i>LHD: (B301) No. 11 — No. 12:</i> <i>RHD: (F49) No. 11 — No. 12:</i> DTC 24 <i>LHD: (B301) No. 9 — No. 10:</i> <i>RHD: (F49) No. 9 — No. 10:</i> DTC 26 <i>LHD: (B301) No. 14 — No. 15:</i> <i>RHD: (F49) No. 14 — No. 15:</i> DTC 28 <i>LHD: (B301) No. 7 — No. 8:</i> <i>RHD: (F49) No. 7 — No. 8:</i>	Is the resistance the following value? Front: 1 — 1.5 k Ω Rear: 1.025 — 1.265 k Ω	Go to step 11.	Repair the harness connector between ABSCM&H/U and ABS wheel speed sensor.
11 CHECK GROUND SHORT OF HARNESS. Measure the resistance between ABSCM&H/U connector and chassis ground. <i>Connector & terminal</i> DTC 22 <i>LHD: (B301) No. 11 — Chassis ground:</i> <i>RHD: (F49) No. 11 — Chassis ground:</i> DTC 24 <i>LHD: (B301) No. 9 — Chassis ground:</i> <i>RHD: (F49) No. 9 — Chassis ground:</i> DTC 26 <i>LHD: (B301) No. 14 — Chassis ground:</i> <i>RHD: (F49) No. 14 — Chassis ground:</i> DTC 28 <i>LHD: (B301) No. 7 — Chassis ground:</i> <i>RHD: (F49) No. 7 — Chassis ground:</i>	Is the resistance more than 1 M Ω ?	Go to step 12.	Repair the harness connector between ABSCM&H/U and ABS wheel speed sensor.
12 CHECK GROUND CIRCUIT OF ABSCM&H/U. Measure the resistance between ABSCM&H/U and chassis ground. <i>Connector & terminal</i> <i>(B301) No. 23 — Chassis ground:</i>	Is the resistance less than 0.5 Ω ?	Go to step 13.	Repair the ABSCM&H/U ground harness.
13 CHECK POOR CONTACT IN CONNECTORS.	Is there poor contact in connectors between ABSCM&H/U and ABS wheel speed sensor?	Repair the connector.	Go to step 14.
14 CHECK SOURCES OF SIGNAL NOISE.	Is the car phone or wireless transmitter properly installed?	Go to step 15.	Properly install the car phone or wireless transmitter.
15 CHECK SOURCES OF SIGNAL NOISE.	Are noise sources (such as an antenna) installed near the sensor harness?	Install the noise sources apart from sensor harness.	Go to step 16.

Diagnostics Procedure without Diagnostic Trouble Code (DTC)

ABS (DIAGNOSTIC)

Step	Check	Yes	No
16 CHECK SHIELD CIRCUIT. 1) Disconnect the connectors (B303) and (F62). 2) Measure the resistance between shield connector and chassis ground. <i>Connector & terminal</i> <i>DTC 22</i> <i>LHD: (F103) No. 1 — Chassis ground:</i> <i>RHD: (F48) No. 2 — Chassis ground:</i> <i>DTC 24</i> <i>LHD: (F103) No. 8 — Chassis ground:</i> <i>RHD: (F48) No. 1 — Chassis ground:</i> <i>DTC 26</i> <i>LHD: (F103) No. 2 — Chassis ground:</i> <i>RHD: (F48) No. 3 — Chassis ground:</i> <i>DTC 28</i> <i>LHD: (F103) No. 2 — Chassis ground:</i> <i>RHD: (F48) No. 3 — Chassis ground:</i>	Is the resistance less than 0.5 Ω ?	Go to step 17.	Repair the shield harness.
17 CHECK ABSCM&H/U. 1) Connect all connectors. 2) Erase the memory. 3) Perform the inspection mode. 4) Read out the DTC.	Is the same DTC as in current diagnosis still being output?	Replace the ABSCM only. <Ref. to ABS-8, ABSCM (ABS CONTROL MODULE), REPLACE, ABS Control Module and Hydraulic Control Unit (ABSCM&H/U).>	Go to step 18.
18 CHECK ANY OTHER DIAGNOSTIC TROUBLE CODES (DTCs) APPEARANCE.	Are other DTCs being output?	Proceed with the diagnosis corresponding to DTC.	A temporary noise interference. NOTE: Although the ABS warning light remains illuminating at this point, this is a normal condition. Vehicle must be driven at approx. 12 km/h (7.46 MPH) or faster to turn off ABS warning light. Make sure that the ABS warning light goes off after driving vehicle.

**M: DTC 29 ABNORMAL ABS SENSOR (ABNORMAL ABS SENSOR SIGNAL)
(ANY ONE OF FOUR)**

DIAGNOSIS:

- Faulty ABS wheel speed sensor signal (noise, irregular signal, etc.)
- Faulty tone wheel
- Wheels turning freely for a long time

TROUBLE SYMPTOM:

- ABS does not operate.
- EBD does not operate.

NOTE:

In addition to the ABS warning light, brake warning light illuminates.

Diagnostics Procedure without Diagnostic Trouble Code (DTC)

ABS (DIAGNOSTIC)

WIRING DIAGRAM:

- LHD model

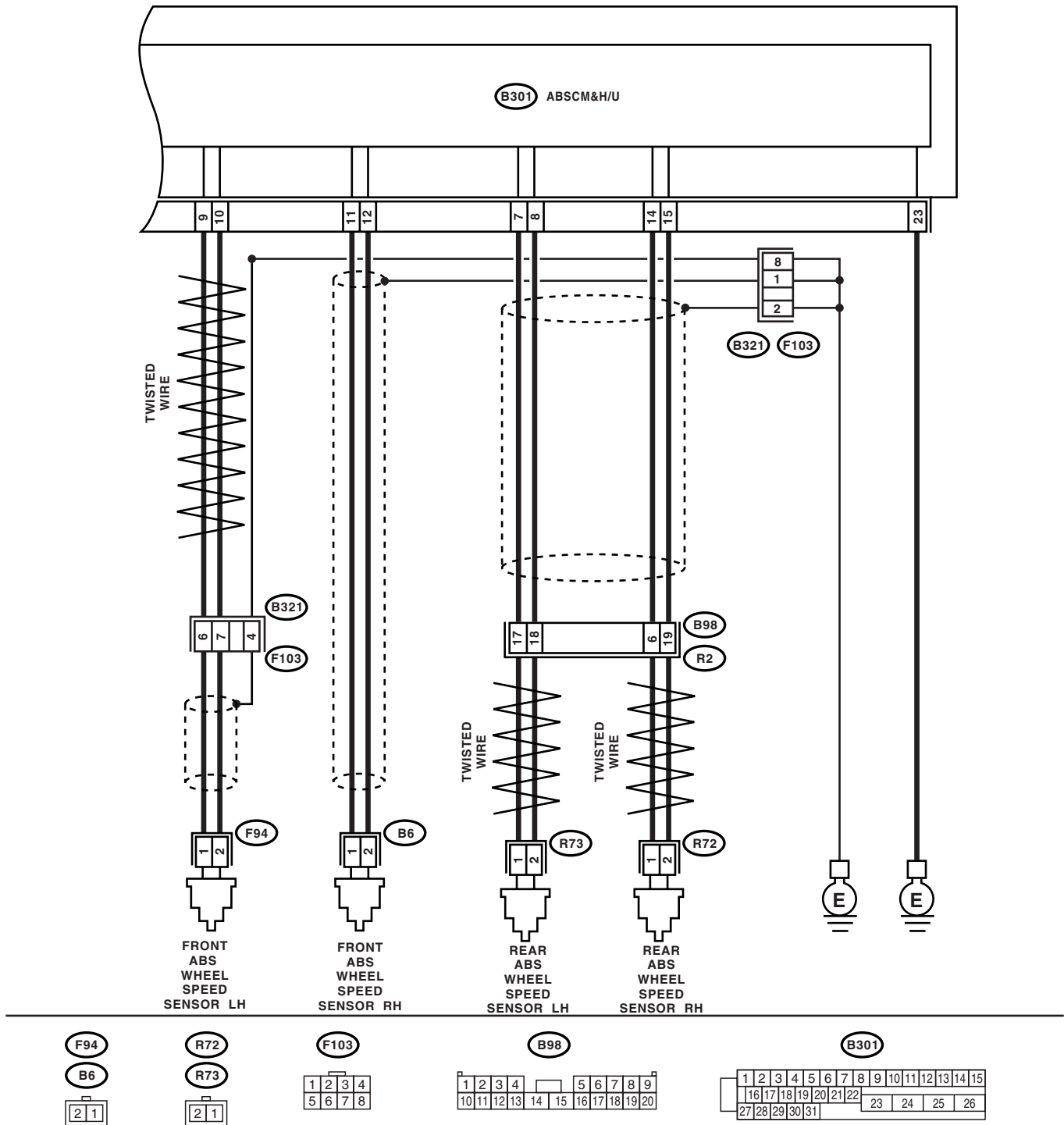

ABS00454

Diagnostics Procedure without Diagnostic Trouble Code (DTC)

ABS (DIAGNOSTIC)

- RHD model

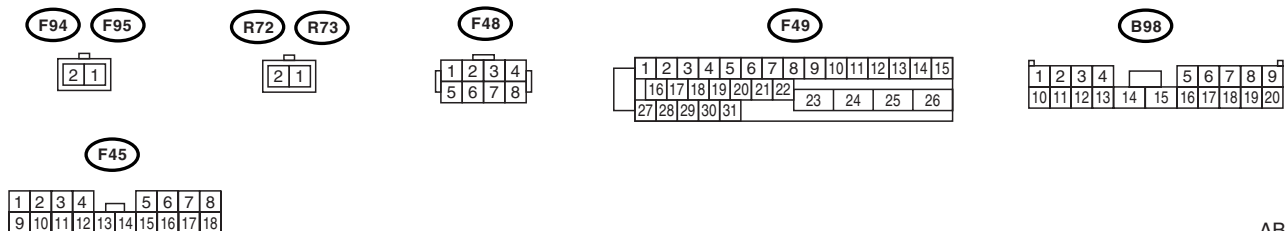
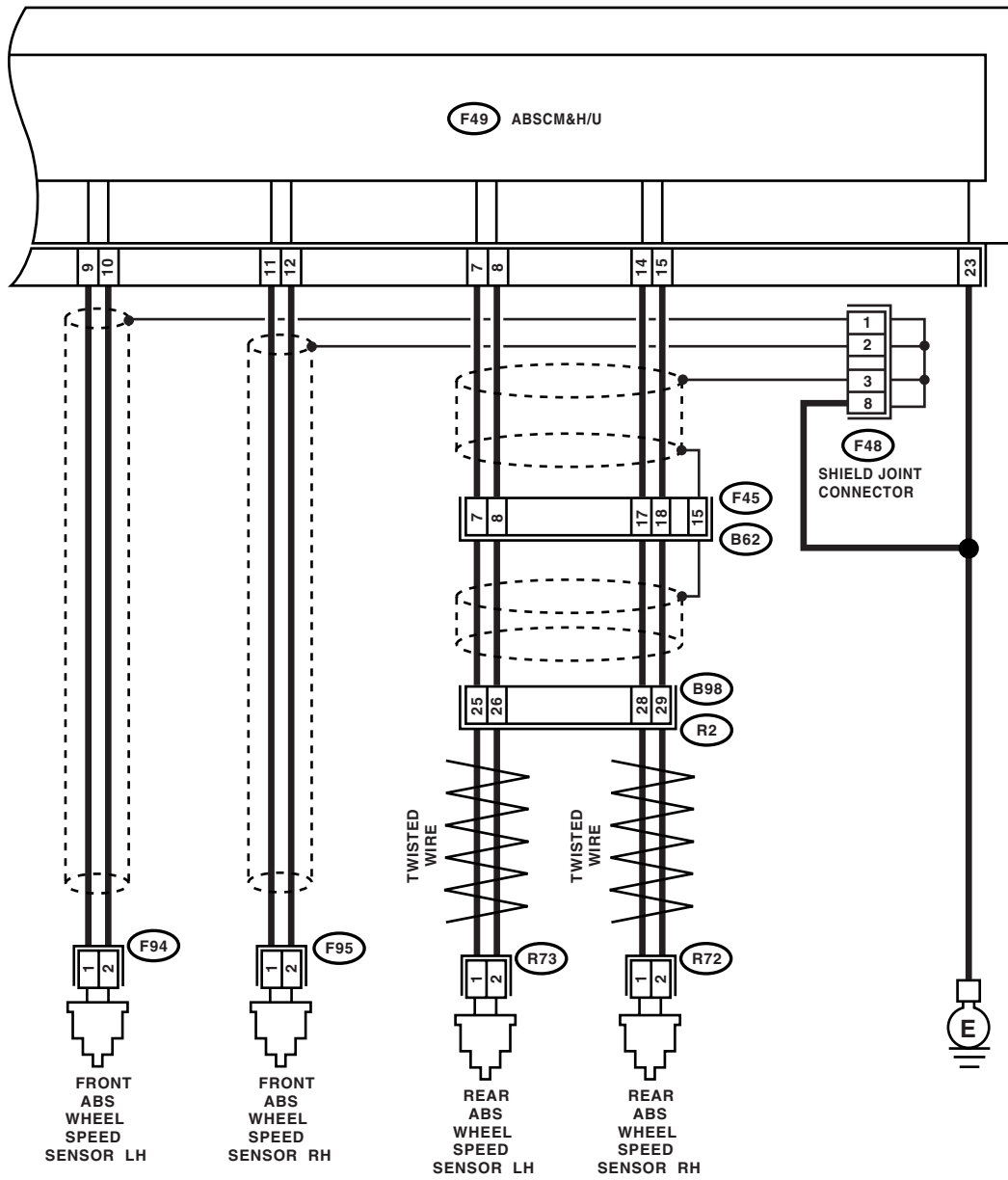

ABS00467

Diagnostics Procedure without Diagnostic Trouble Code (DTC)

ABS (DIAGNOSTIC)

Step	Check	Yes	No	
1	<p>CHECK IF THE WHEELS HAVE TURNED FREELY FOR A LONG TIME. Check if the wheels have been turned freely for more than 1 minute, such as when vehicle is jacked-up, under full-lock cornering or when tire is not in contact with road surface.</p>	Have the wheels been turned freely?	<p>The ABS is normal. Erase the DTC.</p> <p>NOTE: When the wheels turn freely for a long time, such as when the vehicle is towed or jacked-up, or when steering wheel is continuously turned all the way, this DTC may sometimes occur.</p>	Go to step 2.
2	<p>CHECK TIRE SPECIFICATIONS. Turn the ignition switch to OFF.</p>	Are the tire specifications correct?	Go to step 3.	Replace the tire.
3	CHECK WEAR OF TIRE.	Is the tire worn excessively?	Replace the tire.	Go to step 4.
4	CHECK TIRE PRESSURE.	Is the tire pressure correct?	Go to step 5.	Adjust tire pressure.
5	CHECK INSTALLATION OF ABS WHEEL SPEED SENSOR.	Are the ABS wheel speed sensor installation bolts tightened 33 N·m (3.4 kgf-m, 24.6 ft-lb)?	Go to step 6.	Tighten the ABS wheel speed sensor installation bolts securely.
6	<p>CHECK ABS WHEEL SPEED SENSOR GAP. Measure the tone wheel to ABS wheel speed sensor piece gap over entire perimeter of the wheel.</p>	<p>Is the gap the following value?</p> <p>Front wheel: 0.3 — 0.8 mm (0.012 — 0.031 in)</p> <p>Rear wheel: 0.7 — 1.2 mm (0.028 — 0.047 in)</p>	Go to step 7.	<p>Adjust the gap.</p> <p>NOTE: Adjust the gap using spacer (Part No. 26755AA000). If the spacer cannot correct gap, replace worn ABS wheel speed sensor or worn tone wheel.</p>
7	PREPARE OSCILLOSCOPE.	Is an oscilloscope available?	Go to step 8.	Go to step 9.

Diagnostics Procedure without Diagnostic Trouble Code (DTC)

ABS (DIAGNOSTIC)

Step	Check	Yes	No
<p>8 CHECK ABS WHEEL SPEED SENSOR SIGNAL. 1) Raise all four wheels off ground. 2) Turn the ignition switch to OFF. 3) Connect the oscilloscope to the connector. 4) Turn the ignition switch to ON. 5) Rotate the wheels and measure voltage at specified frequency. <Ref. to ABS-17, WAVEFORM, Control Module I/O Signal.></p> <p>NOTE: When this inspection is completed, the ABS-SCM&H/U sometimes stores the DTC 29.</p> <p>Connector & terminal Front RH <i>LHD: (B6) No. 1 (+) — No. 2 (-):</i> <i>RHD: (F95) No. 1 (+) — No. 2 (-):</i> Front LH <i>LHD: (F103) No. 6 (+) — No. 7 (-):</i> <i>RHD: (F94) No. 1 (+) — No. 2 (-):</i> Rear RH <i>LHD: (B98) No. 6 (+) — No. 19 (-):</i> <i>RHD: (B98) No. 28 (+) — No. 29 (-):</i> Rear LH <i>LHD: (B98) No. 17 (+) — No. 18 (-):</i> <i>RHD: (B98) No. 25 (+) — No. 26 (-):</i></p>	<p>Is an oscilloscope pattern smooth, as shown in the figure? <Ref. to ABS-17, WAVEFORM, Control Module I/O Signal.></p>	<p>Go to step 12.</p>	<p>Go to step 9.</p>
<p>9 CHECK CONTAMINATION OF ABS WHEEL SPEED SENSOR OR TONE WHEEL. Remove the disc rotor or drum from hub.</p>	<p>Is the ABS wheel speed sensor piece or the tone wheel contaminated by dirt or other foreign matter?</p>	<p>Thoroughly remove dirt or other foreign matter.</p>	<p>Go to step 10.</p>
<p>10 CHECK DAMAGE OF ABS WHEEL SPEED SENSOR OR TONE WHEEL.</p>	<p>Are there broken or damaged in the ABS wheel speed sensor piece or the tone wheel?</p>	<p>Replace the ABS wheel speed sensor or tone wheel. Front: <Ref. to ABS-15, Front ABS Wheel Speed Sensor.> Rear: <Ref. to ABS-18, Rear ABS Wheel Speed Sensor.> and Front: <Ref. to ABS-21, Front Tone Wheel.> Rear: <Ref. to ABS-22, Rear Tone Wheel.></p>	<p>Go to step 11.</p>
<p>11 CHECK TONE WHEEL RUNOUT. Measure the tone wheel runout.</p>	<p>Is the runout less than 0.05 mm (0.0020 in)?</p>	<p>Go to step 12.</p>	<p>Replace the tone wheel. Front: <Ref. to ABS-21, Front Tone Wheel.> Rear: <Ref. to ABS-22, Rear Tone Wheel.></p>

Diagnosics Procedure without Diagnostic Trouble Code (DTC)

ABS (DIAGNOSTIC)

Step	Check	Yes	No
12 CHECK ABSCM&H/U. 1) Turn the ignition switch to OFF. 2) Connect all connectors. 3) Erase the memory. 4) Perform the inspection mode. 5) Read out the DTC.	Is the same DTC as in current diagnosis still being output?	Replace the ABSCM only. <Ref. to ABS-8, ABSCM (ABS CONTROL MODULE), REPLACE, ABS Control Module and Hydraulic Control Unit (ABSCM&H/U).>	Go to step 13 .
13 CHECK ANY OTHER DIAGNOSTIC TROUBLE CODES (DTCs) APPEARANCE.	Are other DTCs being output?	Proceed with the diagnosis corresponding to DTC.	A temporary poor contact.

N: DTC 31 ABNORMAL INLET SOLENOID VALVE CIRCUIT(S) IN ABSCM&H/U (FRONT RH)

NOTE:

For the diagnostic procedure, refer to DTC 37. <Ref. to ABS-68, DTC 37 ABNORMAL INLET SOLENOID VALVE CIRCUIT(S) IN ABSCM&H/U (REAR LH), Diagnostics Procedure without Diagnostic Trouble Code (DTC).>

O: DTC 33 ABNORMAL INLET SOLENOID VALVE CIRCUIT(S) IN ABSCM&H/U (FRONT LH)

NOTE:

For the diagnostic procedure, refer to DTC 37. <Ref. to ABS-68, DTC 37 ABNORMAL INLET SOLENOID VALVE CIRCUIT(S) IN ABSCM&H/U (REAR LH), Diagnostics Procedure without Diagnostic Trouble Code (DTC).>

P: DTC 35 ABNORMAL INLET SOLENOID VALVE CIRCUIT(S) IN ABSCM&H/U (REAR RH)

NOTE:

For the diagnostic procedure, refer to DTC 37. <Ref. to ABS-68, DTC 37 ABNORMAL INLET SOLENOID VALVE CIRCUIT(S) IN ABSCM&H/U (REAR LH), Diagnostics Procedure without Diagnostic Trouble Code (DTC).>

Diagnostics Procedure without Diagnostic Trouble Code (DTC)

ABS (DIAGNOSTIC)

Q: DTC 37 ABNORMAL INLET SOLENOID VALVE CIRCUIT(S) IN ABSCM&H/U (REAR LH)

DIAGNOSIS:

- Faulty harness connector
- Faulty inlet solenoid valve in ABSCM&H/U

TROUBLE SYMPTOM:

- ABS does not operate.
- EBD does not operate.

NOTE:

In addition to the ABS warning light, brake warning light illuminates.

Diagnostics Procedure without Diagnostic Trouble Code (DTC)

ABS (DIAGNOSTIC)

WIRING DIAGRAM:

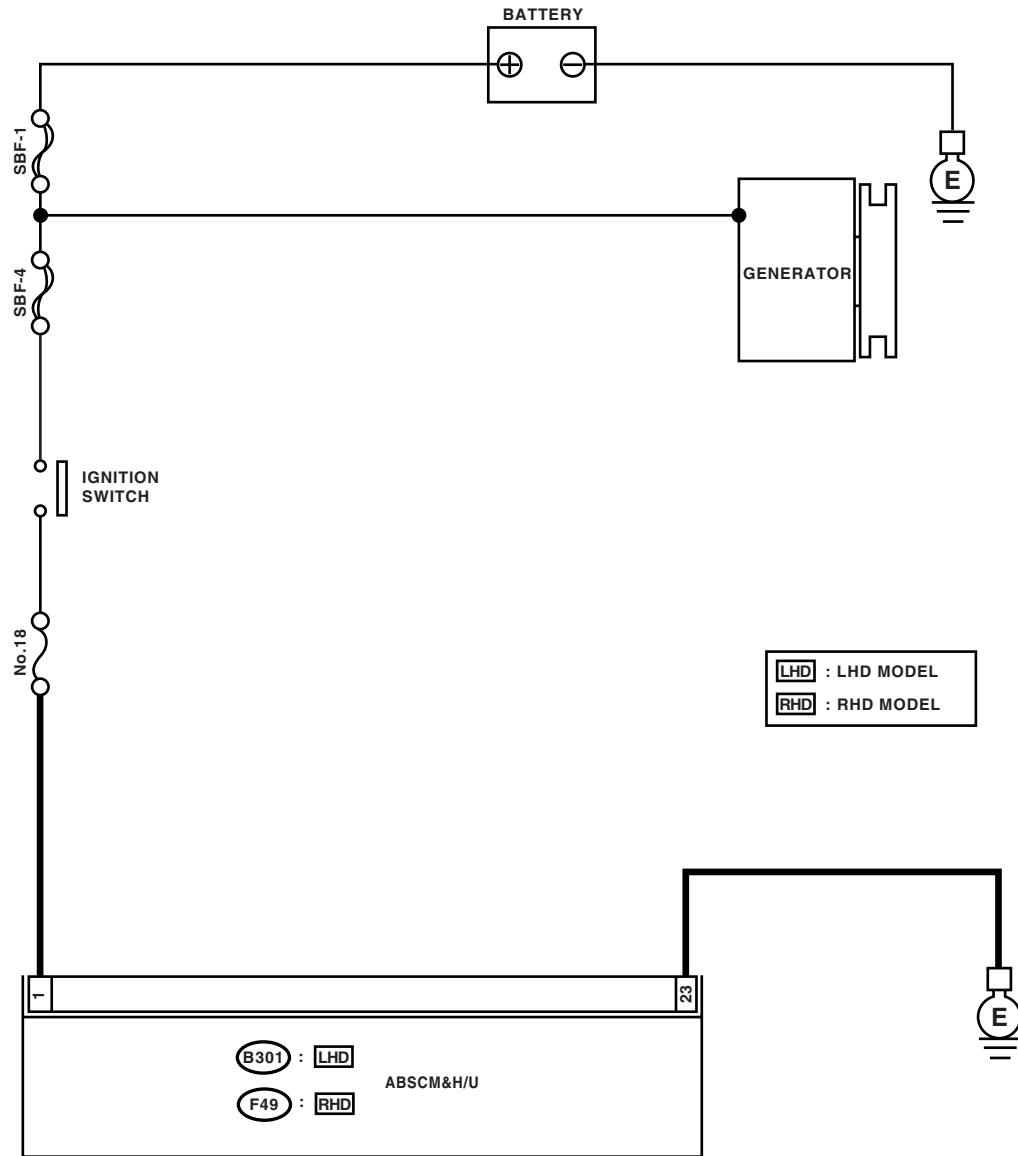

B301 : LHD

F49 : RHD

1	2	3	4	5	6	7	8	9	10	11	12	13	14	15
16	17	18	19	20	21	22	23	24	25	26				
27	28	29	30	31										

ABS00229

Diagnostics Procedure without Diagnostic Trouble Code (DTC)

ABS (DIAGNOSTIC)

Step	Check	Yes	No
1 CHECK INPUT VOLTAGE OF ABSCM&H/U. 1) Turn the ignition switch to OFF. 2) Disconnect the connector from ABSCM&H/U. 3) Run the engine at idle. 4) Measure the voltage between ABSCM&H/U connector and chassis ground. <i>Connector & terminal</i> <i>(B301) No. 1 (+) — Chassis ground (-):</i>	Is the voltage 10 — 15 V?	Go to step 2.	Repair the harness connector between ABS relay and ABSCM&H/U.
2 CHECK GROUND CIRCUIT OF ABSCM&H/U. 1) Turn the ignition switch to OFF. 2) Measure the resistance between ABSCM&H/U connector and chassis ground. <i>Connector & terminal</i> <i>LHD: (B301) No. 23 — Chassis ground:</i> <i>RHD: (F49) No. 23 — Chassis ground:</i>	Is the resistance less than 0.5 Ω ?	Go to step 3.	Repair the ABSCM&H/U ground harness.
3 CHECK POOR CONTACT IN CONNECTORS.	Is there poor contact in connectors among generator, battery and ABSCM&H/U?	Repair the connector.	Go to step 4.
4 CHECK ABSCM&H/U. 1) Connect all connectors. 2) Erase the memory. 3) Perform the inspection mode. 4) Read out the DTC.	Is the same DTC as in the current diagnosis still being output?	Replace the ABSCM&H/U. <Ref. to ABS-7, ABS Control Module and Hydraulic Control Unit (ABSCM&H/U).>	Go to step 5.
5 CHECK ANY OTHER DIAGNOSTIC TROUBLE CODES (DTCs) APPEARANCE.	Are other DTCs being output?	Proceed with the diagnosis corresponding to DTC.	A temporary poor contact.

**R: DTC 32 ABNORMAL OUTLET SOLENOID VALVE CIRCUIT(S) IN ABSCM&H/
U (FRONT RH)**

NOTE:

For the diagnostic procedure, refer to DTC 38. <Ref. to ABS-72, DTC 38 ABNORMAL OUTLET SOLENOID VALVE CIRCUIT(S) IN ABSCM&H/U (REAR LH), Diagnostics Procedure without Diagnostic Trouble Code (DTC).>

**S: DTC 34 ABNORMAL OUTLET SOLENOID VALVE CIRCUIT(S) IN ABSCM&H/
U (FRONT LH)**

NOTE:

For the diagnostic procedure, refer to DTC 38. <Ref. to ABS-72, DTC 38 ABNORMAL OUTLET SOLENOID VALVE CIRCUIT(S) IN ABSCM&H/U (REAR LH), Diagnostics Procedure without Diagnostic Trouble Code (DTC).>

**T: DTC 36 ABNORMAL OUTLET SOLENOID VALVE CIRCUIT(S) IN ABSCM&H/
U (REAR RH)**

NOTE:

For the diagnostic procedure, refer to DTC 38. <Ref. to ABS-72, DTC 38 ABNORMAL OUTLET SOLENOID VALVE CIRCUIT(S) IN ABSCM&H/U (REAR LH), Diagnostics Procedure without Diagnostic Trouble Code (DTC).>

Diagnostics Procedure without Diagnostic Trouble Code (DTC)

ABS (DIAGNOSTIC)

U: DTC 38 ABNORMAL OUTLET SOLENOID VALVE CIRCUIT(S) IN ABSCM&H/ U (REAR LH)

DIAGNOSIS:

- Faulty harness connector
- Faulty outlet solenoid valve in ABSCM&H/U

TROUBLE SYMPTOM:

- ABS does not operate.
- EBD does not operate.

NOTE:

In addition to the ABS warning light, brake warning light illuminates.

Diagnostics Procedure without Diagnostic Trouble Code (DTC)

ABS (DIAGNOSTIC)

WIRING DIAGRAM:

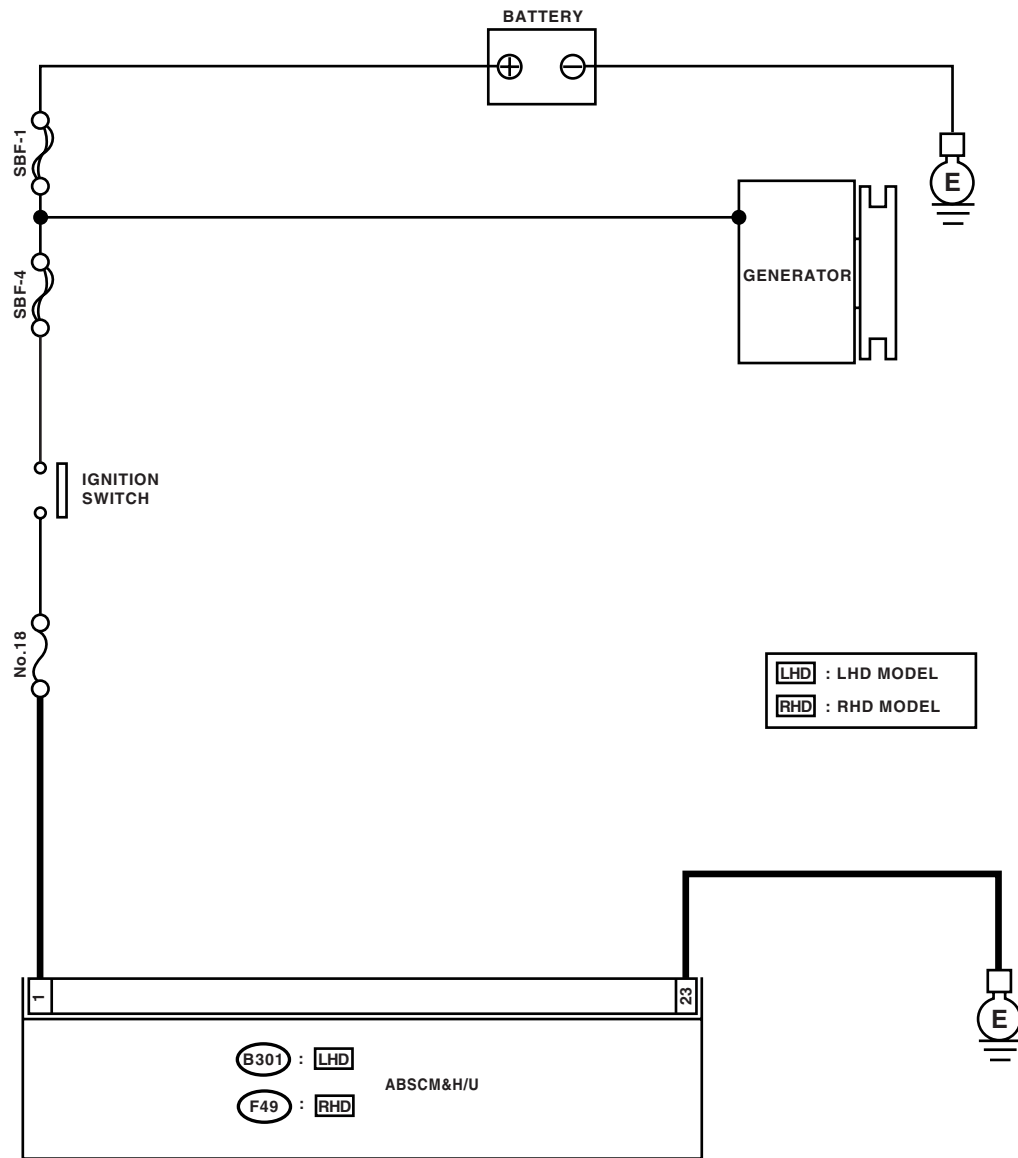

(B301) : LHD

(F49) : RHD

1	2	3	4	5	6	7	8	9	10	11	12	13	14	15
16	17	18	19	20	21	22	23	24	25	26				
27	28	29	30	31										

ABS00229

Diagnostics Procedure without Diagnostic Trouble Code (DTC)

ABS (DIAGNOSTIC)

Step	Check	Yes	No
1 CHECK INPUT VOLTAGE OF ABSCM&H/U. 1) Turn the ignition switch to OFF. 2) Disconnect the connector from ABSCM&H/U. 3) Run the engine at idle. 4) Measure the voltage between ABSCM&H/U connector and chassis ground. Connector & terminal LHD: (B301) No. 1 (+) — Chassis ground (-): RHD: (F49) No. 1 (+) — Chassis ground (-):	Is the voltage 10 — 15 V?	Go to step 2.	Repair the power supply circuit and ABSCM&H/U.
2 CHECK GROUND CIRCUIT OF ABSCM&H/U. 1) Turn the ignition switch to OFF. 2) Measure the resistance between ABSCM&H/U connector and chassis ground. Connector & terminal LHD: (B301) No. 23 — Chassis ground: RHD: (F49) No. 23 — Chassis ground:	Is the resistance less than 0.5 Ω ?	Go to step 3.	Repair the ABSCM&H/U ground harness.
3 CHECK POOR CONTACT IN CONNECTORS.	Is there poor contact in connectors among generator, battery and ABSCM&H/U?	Repair the connector.	Go to step 4.
4 CHECK ABSCM&H/U. 1) Connect all connectors. 2) Erase the memory. 3) Perform the inspection mode. 4) Read out the DTC.	Is the same DTC as in the current diagnosis still being output?	Replace the ABSCM&H/U. <Ref. to ABS-7, ABS Control Module and Hydraulic Control Unit (ABSCM&H/U).>	Go to step 5.
5 CHECK ANY OTHER DIAGNOSTIC TROUBLE CODES (DTCs) APPEARANCE.	Are other DTCs being output?	Proceed with the diagnosis corresponding to DTC.	A temporary poor contact.

V: DTC 41 ABNORMAL ABS CONTROL MODULE

DIAGNOSIS:

Faulty ABSCM&H/U.

TROUBLE SYMPTOM:

- ABS does not operate.
- EBD does not operate.

NOTE:

In addition to the ABS warning light, brake warning light illuminates.

WIRING DIAGRAM:

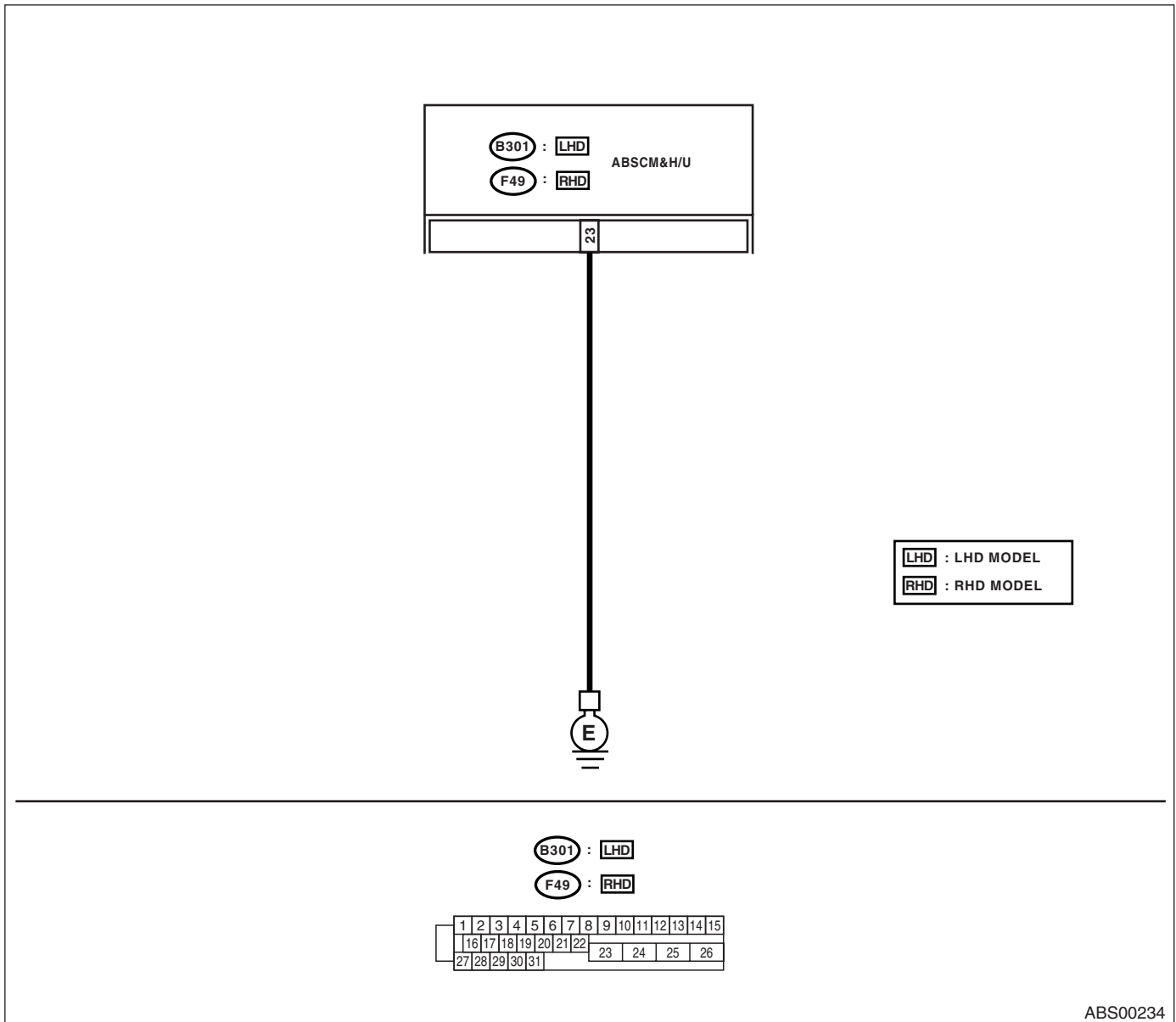

ABS00234

Diagnostics Procedure without Diagnostic Trouble Code (DTC)

ABS (DIAGNOSTIC)

Step	Check	Yes	No
1 CHECK GROUND CIRCUIT OF ABSCM&H/U. 1) Turn the ignition switch to OFF. 2) Disconnect the connector from ABSCM&H/U. 3) Measure the resistance between ABSCM&H/U and chassis ground. <i>Connector & terminal</i> <i>LHD: (B301) No. 23 — Chassis ground:</i> <i>RHD: (F49) No. 23 — Chassis ground:</i>	Is the resistance less than 0.5 Ω ?	Go to step 2.	Repair the ABSCM&H/U ground harness.
2 CHECK POOR CONTACT IN CONNECTORS.	Is there poor contact in connectors between battery, ignition switch and ABSCM&H/U?	Repair the connector.	Go to step 3.
3 CHECK SOURCES OF SIGNAL NOISE.	Is the car telephone or the wireless transmitter properly installed?	Go to step 4.	Properly install the car telephone or wireless transmitter.
4 CHECK SOURCES OF SIGNAL NOISE.	Are noise sources (such as an antenna) installed near the sensor harness?	Install the noise sources apart from the sensor harness.	Go to step 5.
5 CHECK ABSCM&H/U. 1) Connect all connectors. 2) Erase the memory. 3) Perform the inspection mode. 4) Read out the DTC.	Is the same DTC as in current diagnosis still being output?	Replace the ABSCM only. <Ref. to ABS-8, ABSCM (ABS CONTROL MODULE), REPLACE, ABS Control Module and Hydraulic Control Unit (ABSCM&H/U).>	Go to step 6.
6 CHECK ANY OTHER DIAGNOSTIC TROUBLE CODES (DTCs) APPEARANCE.	Are other DTCs being output?	Proceed with the diagnosis corresponding to DTC.	A temporary poor contact.

W: DTC 42 SOURCE VOLTAGE IS ABNORMAL.

DIAGNOSIS:

Power source voltage of the ABSCM&H/U is low or high.

TROUBLE SYMPTOM:

- ABS does not operate.
- EBD does not operate.

NOTE:

In addition to the ABS warning light, brake warning light illuminates temporarily. Both warning lights go off on the recovery of voltage.

Diagnostics Procedure without Diagnostic Trouble Code (DTC)

ABS (DIAGNOSTIC)

WIRING DIAGRAM:

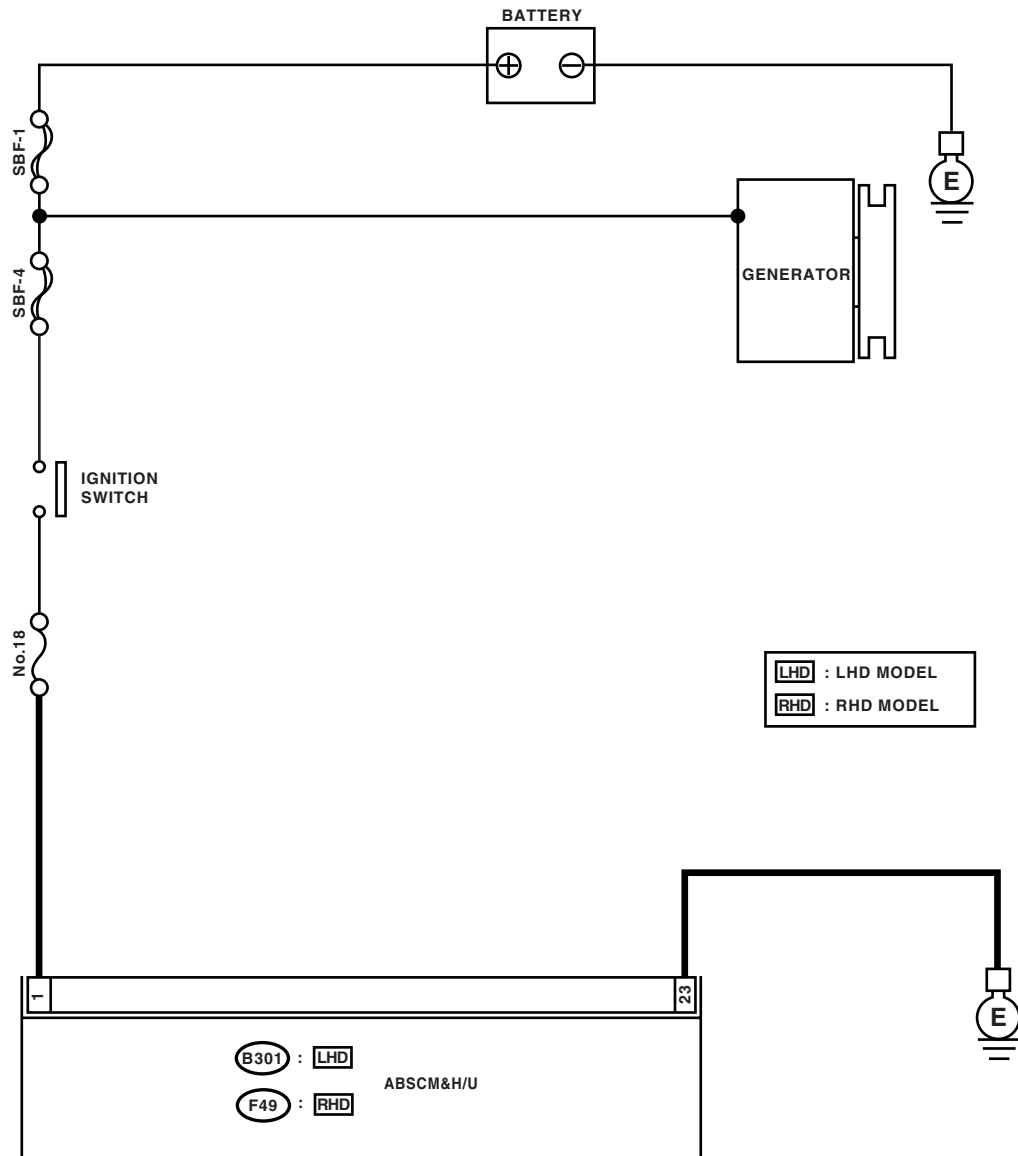

(B301) : LHD

(F49) : RHD

1	2	3	4	5	6	7	8	9	10	11	12	13	14	15
16	17	18	19	20	21	22	23	24	25	26				
27	28	29	30	31										

ABS00229

Diagnostics Procedure without Diagnostic Trouble Code (DTC)

ABS (DIAGNOSTIC)

Step	Check	Yes	No
1 CHECK GENERATOR. 1) Start the engine. 2) Idle after warm-up. 3) Measure the voltage between generator B terminal and chassis ground. <i>Terminal</i> <i>Generator B terminal (+) — Chassis ground (-):</i>	Is the voltage 10 — 17 V?	Go to step 2.	Repair the generator. <Ref. to SC(H4SO)-15, Generator.>
2 CHECK BATTERY TERMINAL. Turn the ignition switch to OFF.	Are the positive and negative battery terminals tightly clamped?	Go to step 3.	Tighten the clamp of terminal.
3 CHECK INPUT VOLTAGE OF ABSCM&H/U. 1) Disconnect the connector from ABSCM&H/U. 2) Run the engine at idle. 3) Operate the electric load applying devices, such as the headlight, A/C, and defogger. 4) Measure the voltage between ABSCM&H/U connector and chassis ground. <i>Connector & terminal</i> <i>LHD: (B301) No. 1 (+) — Chassis ground (-):</i> <i>RHD: (F49) No. 1 (+) — Chassis ground (-):</i>	Is the voltage 10 — 17 V?	Go to step 4.	Repair the harness connector between battery, ignition switch and ABSCM&H/U.
4 CHECK GROUND CIRCUIT OF ABSCM&H/U. 1) Turn the ignition switch to OFF. 2) Measure the resistance between ABSCM&H/U connector and chassis ground. <i>Connector & terminal</i> <i>LHD: (B301) No. 23 — Chassis ground:</i> <i>RHD: (F49) No. 23 — Chassis ground:</i>	Is the resistance less than 0.5 Ω ?	Go to step 5.	Repair the ABSCM&H/U ground harness.
5 CHECK POOR CONTACT IN CONNECTORS.	Is there poor contact in connectors among generator, battery and ABSCM&H/U?	Repair the connector.	Go to step 6.
6 CHECK ABSCM&H/U. 1) Connect all connectors. 2) Erase the memory. 3) Perform the inspection mode. 4) Read out the DTC.	Is the same DTC as in current diagnosis still being output?	Replace the ABSCM only. <Ref. to ABS-8, ABSCM (ABS CONTROL MODULE), REPLACE, ABS Control Module and Hydraulic Control Unit (ABSCM&H/U).>	Go to step 7.
7 CHECK ANY OTHER DIAGNOSTIC TROUBLE CODES (DTCs) APPEARANCE.	Are other DTCs being output?	Proceed with the diagnosis corresponding to DTC.	A temporary poor contact.

Diagnostics Procedure without Diagnostic Trouble Code (DTC)

ABS (DIAGNOSTIC)

X: DTC 44 A COMBINATION OF AT CONTROL ABNORMAL

DIAGNOSIS:

Combination of AT control faults

TROUBLE SYMPTOM:

ABS does not operate.

WIRING DIAGRAM:

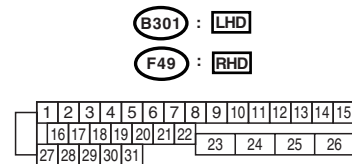
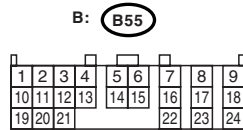
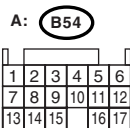
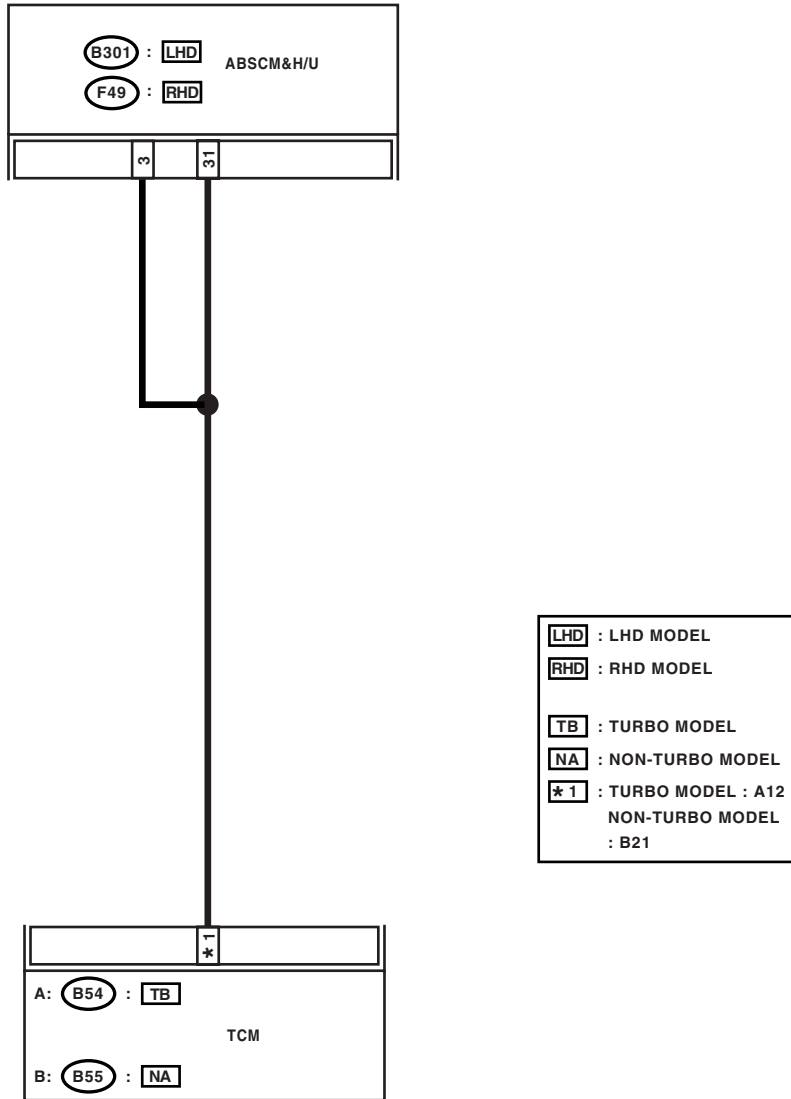

ABS00455

Diagnostics Procedure without Diagnostic Trouble Code (DTC)

ABS (DIAGNOSTIC)

Step	Check	Yes	No	
1	CHECK SPECIFICATIONS OF THE ABSCM&H/U. Check specifications of the mark to on ABSCM&H/U. CO: AT CD: MT	Are the specifications between vehicle and ABSCM&H/U matched?	Go to step 2.	Replace the ABSCM&H/U. <Ref. to ABS-7, ABS Control Module and Hydraulic Control Unit (ABSCM&H/U).>
2	CHECK GROUND SHORT OF HARNESS. 1) Turn the ignition switch to OFF. 2) Disconnect all connectors from TCM. 3) Disconnect the connector from ABSCM&H/U. 4) Measure the resistance between ABSCM&H/U connector and chassis ground. Connector & terminal LHD: (B301) No. 3 — Chassis ground: RHD: (F49) No. 3 — Chassis ground:	Is the resistance more than 1 MΩ?	Go to step 3.	Repair the harness between TCM and ABSCM&H/U.
3	CHECK BATTERY SHORT OF HARNESS. Measure the voltage between ABSCM&H/U connector and chassis ground. Connector & terminal LHD: (B301) No. 3 (+) — Chassis ground (-): RHD: (F49) No. 3 (+) — Chassis ground (-):	Is the voltage less than 1 V?	Go to step 4.	Repair the harness between TCM and ABSCM&H/U.
4	CHECK BATTERY SHORT OF HARNESS. 1) Turn the ignition switch to ON. 2) Measure the voltage between ABSCM&H/U connector and chassis ground. Connector & terminal LHD: (B301) No. 3 (+) — Chassis ground (-): RHD: (F49) No. 3 (+) — Chassis ground (-):	Is the voltage less than 1 V?	Go to step 5.	Repair the harness between TCM and ABSCM&H/U.
5	CHECK TCM. 1) Turn the ignition switch to OFF. 2) Connect all connectors to TCM. 3) Turn the ignition switch to ON. 4) Measure the voltage between TCM connector terminal and chassis ground. Connector & terminal Non-turbo Model (B55) No. 21 (+) — Chassis ground (-): Turbo Model (B54) No. 12 (+) — Chassis ground (-):	Is the voltage less than 10 — 15 V?	Go to step 7.	Go to step 6.
6	CHECK AT.	Is the AT functioning normally?	Replace the TCM.	Repair the AT.
7	CHECK OPEN CIRCUIT OF HARNESS. Measure the voltage between ABSCM&H/U connector and chassis ground. Connector & terminal LHD: (B301) No. 3 (+) — Chassis ground (-): (B301) No. 31 (+) — Chassis ground (-): RHD: (F49) No. 3 (+) — Chassis ground (-): (F49) No. 31 (+) — Chassis ground (-):	Is the voltage less than 10 — 15 V?	Go to step 8.	Repair the harness/connector between TCM and ABSCM&H/U.
8	CHECK POOR CONTACT IN CONNECTORS.	Is there poor contact in connectors between TCM and ABSCM&H/U?	Repair the connector.	Go to step 9.

Diagnosics Procedure without Diagnostic Trouble Code (DTC)

ABS (DIAGNOSTIC)

Step	Check	Yes	No
9 CHECK ABSCM&H/U. 1) Turn the ignition switch to OFF. 2) Connect all connectors. 3) Erase the memory. 4) Perform the inspection mode. 5) Read out the DTC.	Is the same DTC as in the current diagnosis still being output?	Replace the ABSCM only. <Ref. to ABS-8, ABSCM (ABS CONTROL MODULE), REPLACE, ABS Control Module and Hydraulic Control Unit (ABSCM&H/U).>	Go to step 10 .
10 CHECK ANY OTHER DIAGNOSTIC TROUBLE CODES (DTCs) APPEARANCE.	Are other DTCs being output?	Proceed with the diagnosis corresponding to DTC.	A temporary poor contact.

Y: DTC 51 ABNORMAL VALVE RELAY

DIAGNOSIS:

Faulty valve relay

TROUBLE SYMPTOM:

- ABS does not operate.
- EBD does not operate in some malfunctions.

NOTE:

In addition to the ABS warning light, brake warning light illuminates, if the EBD does not operate.

WIRING DIAGRAM:

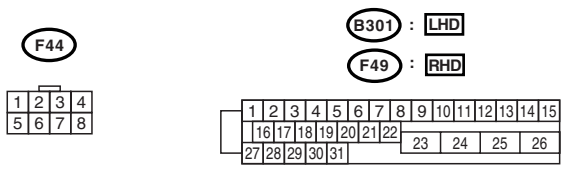
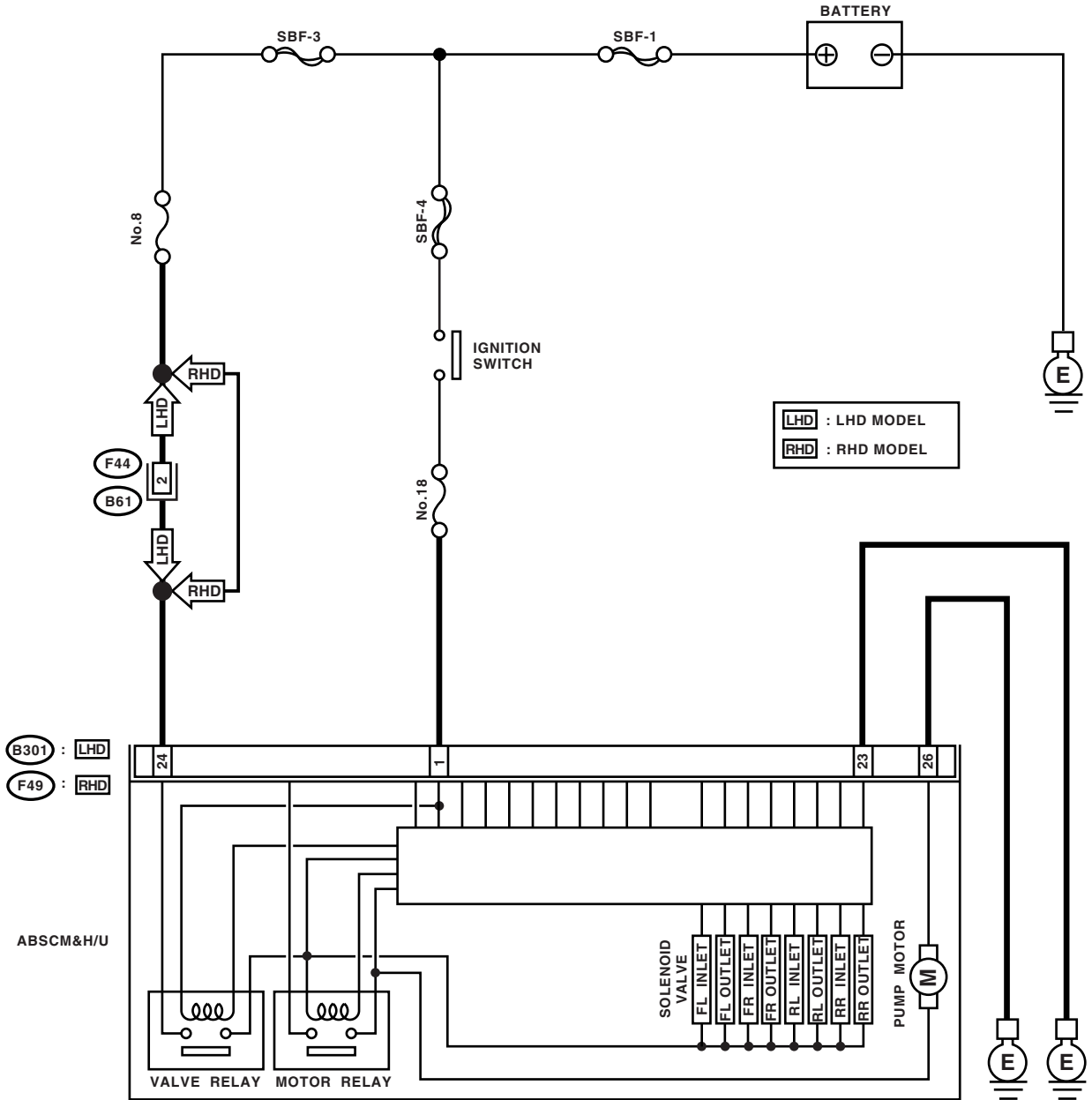

Diagnostics Procedure without Diagnostic Trouble Code (DTC)

ABS (DIAGNOSTIC)

Step	Check	Yes	No
1 CHECK INPUT VOLTAGE OF ABSCM&H/U. 1) Turn the ignition switch to OFF. 2) Disconnect the connector from ABSCM&H/U. 3) Run the engine at idle. 4) Measure the voltage between ABSCM&H/U connector and chassis ground. Connector & terminal LHD: (B301) No. 1 (+) — Chassis ground (-): (B301) No. 24 (+) — Chassis ground (-): RHD: (F49) No. 1 (+) — Chassis ground (-): (B301) No. 24 (+) — Chassis ground (-):	Is the voltage 10 — 15 V?	Go to step 2.	Repair the harness connector between battery, ABS relay and ABSCM&H/U.
2 CHECK GROUND CIRCUIT OF ABSCM&H/U. 1) Turn the ignition switch to OFF. 2) Measure the resistance between ABSCM&H/U connector and chassis ground. Connector & terminal LHD: (B301) No. 23 — Chassis ground: RHD: (F49) No. 23 — Chassis ground:	Is the resistance less than 0.5 Ω ?	Go to step 3.	Repair the ABSCM&H/U ground harness.
3 CHECK VALVE RELAY IN ABSCM&H/U. Measure the resistance between ABSCM&H/U and terminals. Terminals No. 23 — No. 24:	Is the resistance more than 1 M Ω ?	Go to step 4.	Replace the ABSCM only. <Ref. to ABS-8, ABSCM (ABS CONTROL MODULE), REPLACE, ABS Control Module and Hydraulic Control Unit (ABSCM&H/U).>
4 CHECK POOR CONTACT IN CONNECTORS.	Is there poor contact in connectors among generator, battery and ABSCM&H/U?	Repair the connector.	Go to step 5.
5 CHECK ABSCM&H/U. 1) Connect all connectors. 2) Erase the memory. 3) Perform the inspection mode. 4) Read out the DTC.	Is the same DTC as in the current diagnosis still being output?	Replace the ABSCM only. <Ref. to ABS-8, ABSCM (ABS CONTROL MODULE), REPLACE, ABS Control Module and Hydraulic Control Unit (ABSCM&H/U).>	Go to step 6.
6 CHECK ANY OTHER DIAGNOSTIC TROUBLE CODES (DTCs) APPEARANCE.	Are other DTCs being output?	Proceed with the diagnosis corresponding to DTC.	A temporary poor contact.

Z: DTC 52 ABNORMAL MOTOR AND/OR MOTOR RELAY

DIAGNOSIS:

- Faulty motor
- Faulty motor relay
- Faulty harness connector

TROUBLE SYMPTOM:

ABS does not operate.

WIRING DIAGRAM:

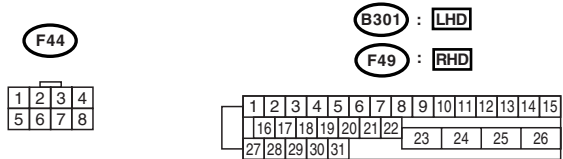
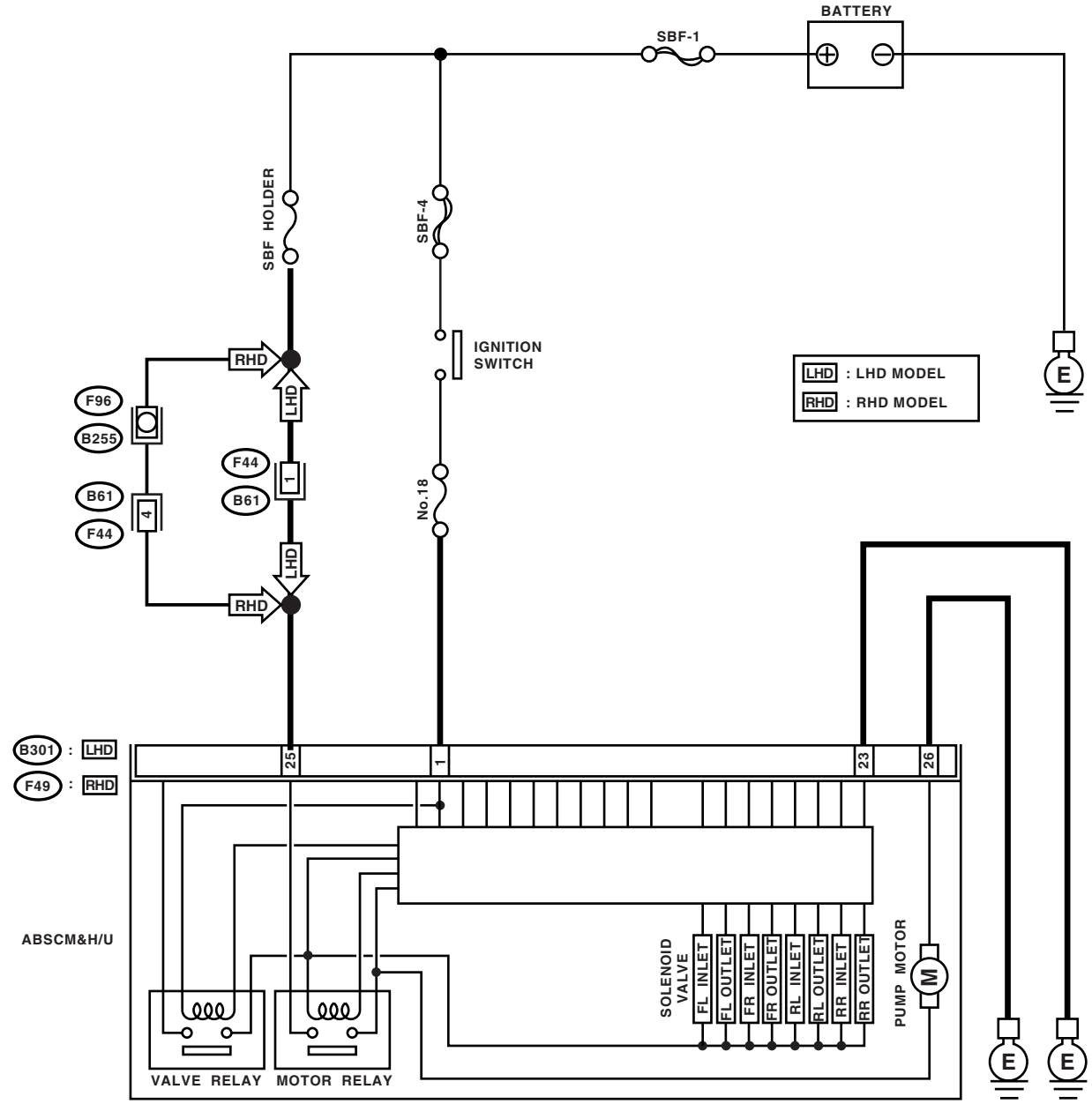

Diagnostics Procedure without Diagnostic Trouble Code (DTC)

ABS (DIAGNOSTIC)

Step	Check	Yes	No
1 CHECK INPUT VOLTAGE OF ABSCM&H/U. 1) Turn the ignition switch to OFF. 2) Disconnect the connector from ABSCM&H/U. 3) Turn the ignition switch to ON. 4) Measure the voltage between ABSCM&H/U connector and chassis ground. Connector & terminal LHD: (B301) No. 25 (+) — Chassis ground (-): RHD: (F49) No. 25 (+) — Chassis ground (-):	Is the voltage 10 — 15 V?	Go to step 2.	Repair the harness/connector between battery and ABSCM&H/U and check fuse SBF-holder.
2 CHECK GROUND CIRCUIT OF MOTOR. 1) Turn the ignition switch to OFF. 2) Measure the resistance between ABSCM&H/U connector and chassis ground. Connector & terminal LHD: (B301) No. 26 — Chassis ground: RHD: (F49) No. 26 — Chassis ground:	Is the resistance less than 0.5 Ω ?	Go to step 3.	Repair the ABSCM&H/U ground harness.
3 CHECK INPUT VOLTAGE OF ABSCM&H/U. 1) Run the engine at idle. 2) Measure the voltage between ABSCM&H/U connector and chassis ground. Connector & terminal LHD: (B301) No. 1 (+) — Chassis ground (-): RHD: (F49) No. 1 (+) — Chassis ground (-):	Is the voltage 10 — 15 V?	Go to step 4.	Repair the harness connector between battery, ignition switch and ABSCM&H/U.
4 CHECK GROUND CIRCUIT OF ABSCM&H/U. 1) Turn the ignition switch to OFF. 2) Measure the resistance between ABSCM&H/U connector and chassis ground. Connector & terminal LHD: (B301) No. 23 — Chassis ground: RHD: (F49) No. 23 — Chassis ground:	Is the resistance less than 0.5 Ω ?	Go to step 5.	Repair the ABSCM&H/U ground harness.
5 CHECK MOTOR OPERATION. Operate the sequence control. <Ref. to ABS-11, ABS Sequence Control.> NOTE: Use the diagnosis connector to operate the sequence control.	Can motor revolution noise (buzz) be heard when carrying out the sequence control?	Go to step 6.	Replace the ABSCM&H/U. <Ref. to ABS-7, ABS Control Module and Hydraulic Control Unit (ABSCM&H/U).>
6 CHECK POOR CONTACT IN CONNECTORS. Turn the ignition switch to OFF.	Is there poor contact in connector among generator, battery and ABSCM&H/U?	Repair the connector.	Go to step 7.
7 CHECK ABSCM&H/U. 1) Connect all connectors. 2) Erase the memory. 3) Perform the inspection mode. 4) Read out the DTC.	Is the same DTC as in the current diagnosis still being output?	Replace the ABSCM&H/U. <Ref. to ABS-7, ABS Control Module and Hydraulic Control Unit (ABSCM&H/U).>	Go to step 8.

Diagnostics Procedure without Diagnostic Trouble Code (DTC)

ABS (DIAGNOSTIC)

Step	Check	Yes	No
8 CHECK ANY OTHER DIAGNOSTIC TROUBLE CODES (DTCs) APPEARANCE.	Are other DTCs being output?	Proceed with the diagnosis corresponding to DTC.	A temporary poor contact. NOTE: Although the ABS warning light remains illuminating at this point, this is a normal condition. Vehicle must be driven at approx. 12 km/h (7.46 MPH) or faster to turn off ABS warning light. Make sure that the ABS warning light goes off after driving vehicle.

Diagnostics Procedure without Diagnostic Trouble Code (DTC)

ABS (DIAGNOSTIC)

AA:DTC 54 ABNORMAL STOP LIGHT SWITCH

DIAGNOSIS:

Faulty stop light switch

TROUBLE SYMPTOM:

ABS does not operate.

WIRING DIAGRAM:

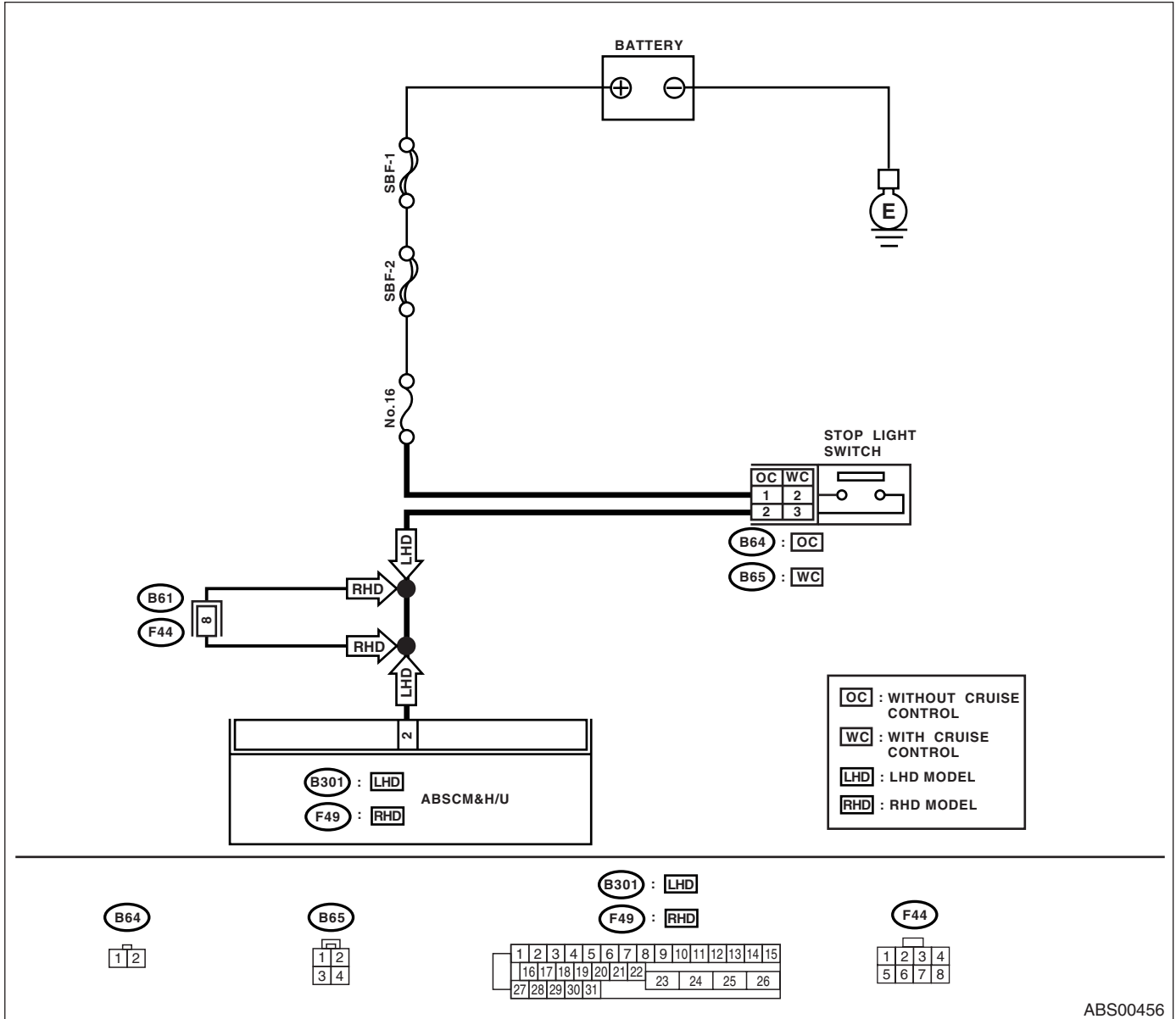

Diagnostics Procedure without Diagnostic Trouble Code (DTC)

ABS (DIAGNOSTIC)

Step	Check	Yes	No
1 CHECK STOP LIGHTS COME ON. Depress the brake pedal.	Do the stop lights come on?	Go to step 2.	Repair the stop lights circuit.
2 CHECK OPEN CIRCUIT IN HARNESS. 1) Turn the ignition switch to OFF. 2) Disconnect the connector from ABSCM&H/U. 3) Depress the brake pedal. 4) Measure the voltage between ABSCM&H/U connector and chassis ground. Connector & terminal LHD: (B301) No. 2 (+) — Chassis ground (-): RHD: (F49) No. 2 (+) — Chassis ground (-):	Is the voltage 10 — 15 V?	Go to step 3.	Repair the harness between stop light switch and ABSCM&H/U.
3 CHECK POOR CONTACT IN CONNECTORS.	Is there poor contact in connector between stop light switch and ABSCM&H/U?	Repair the connector.	Go to step 4.
4 CHECK ABSCM&H/U. 1) Connect all connectors. 2) Erase the memory. 3) Perform the inspection mode. 4) Read out the DTC.	Is the same DTC as in the current diagnosis still being output?	Replace the ABSCM only. <Ref. to ABS-8, ABSCM (ABS CONTROL MODULE), REPLACE, ABS Control Module and Hydraulic Control Unit (ABSCM&H/U).>	Go to step 5.
5 CHECK ANY OTHER DIAGNOSTIC TROUBLE CODES (DTCs) APPEARANCE.	Are other DTCs being output?	Proceed with the diagnosis corresponding to DTC.	A temporary poor contact.

Diagnostics Procedure without Diagnostic Trouble Code (DTC)

ABS (DIAGNOSTIC)

AB:DTC 56 ABNORMAL G SENSOR OUTPUT VOLTAGE

DIAGNOSIS:

Faulty G sensor output voltage

TROUBLE SYMPTOM:

ABS does not operate.

WIRING DIAGRAM:

- LHD model

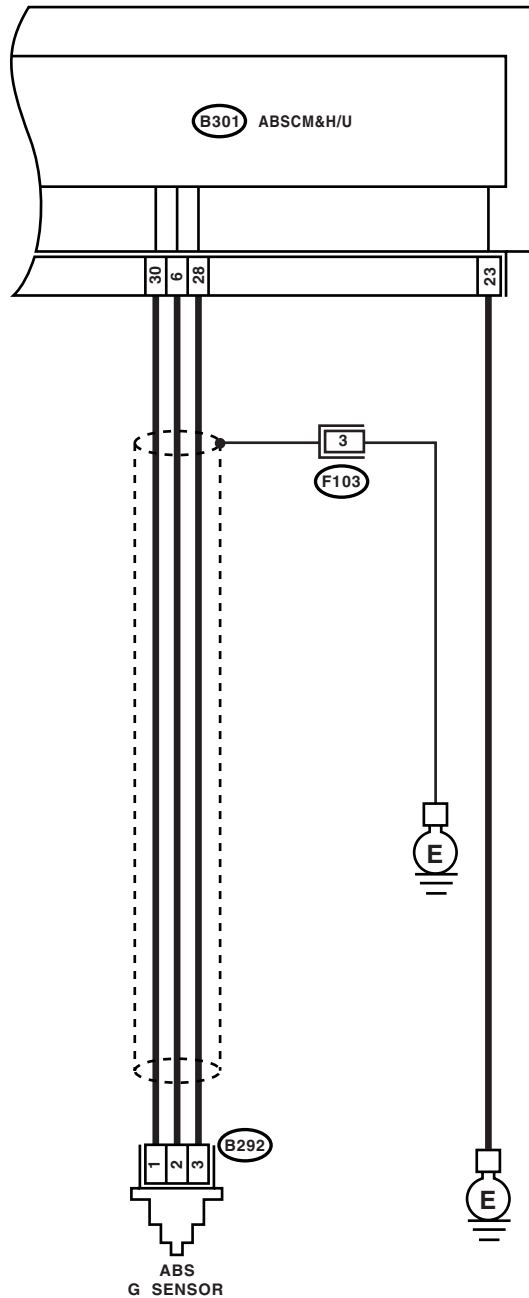

B292

1	2	3
---	---	---

F103

1	2	3	4
5	6	7	8

B301

1	2	3	4	5	6	7	8	9	10	11	12	13	14	15
16	17	18	19	20	21	22	23	24	25	26				
27	28	29	30	31										

ABS00457

Diagnostics Procedure without Diagnostic Trouble Code (DTC)

ABS (DIAGNOSTIC)

- RHD model

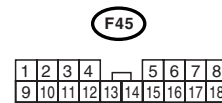
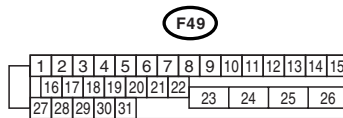
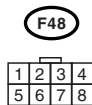
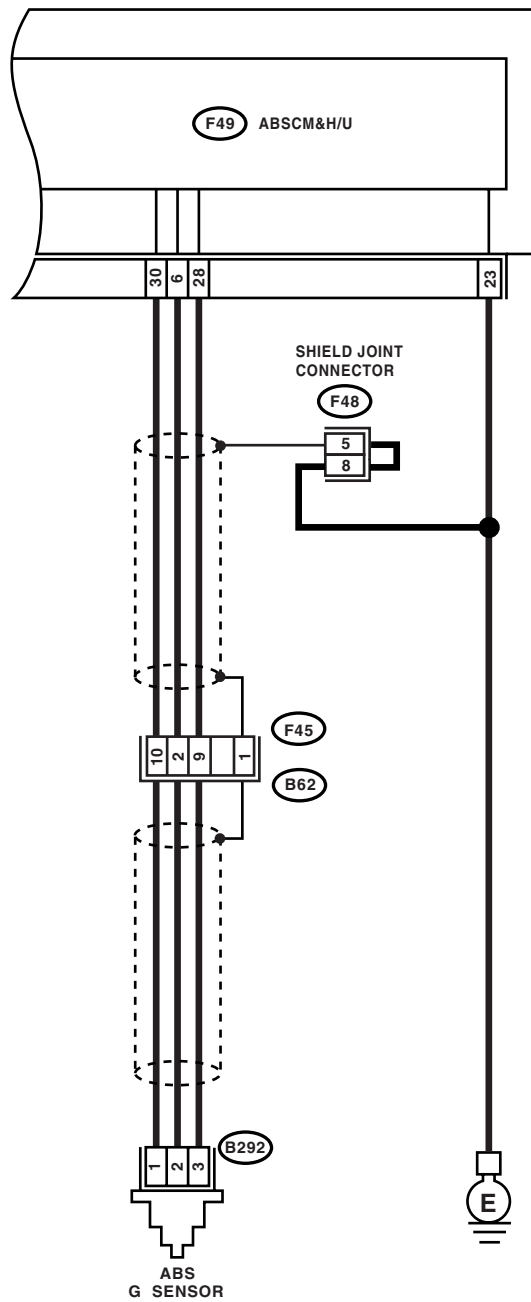

ABS00264

Diagnostics Procedure without Diagnostic Trouble Code (DTC)

ABS (DIAGNOSTIC)

Step	Check	Yes	No
1	CHECK ALL FOUR WHEELS FOR FREE TURNING.	The ABS is normal. Erase the DTC.	Go to step 2.
2	CHECK SPECIFICATIONS OF ABSCM&H/U. Check the specifications of the mark to the ABSCM&H/U. CO: AT CP: MT	Go to step 3.	Replace the ABSCM&H/U. <Ref. to ABS-7, ABS Control Module and Hydraulic Control Unit (ABSCM&H/U).>
3	CHECK INPUT VOLTAGE OF G SENSOR. 1) Turn the ignition switch to OFF. 2) Remove the console box. 3) Remove the G sensor from vehicle. (Do not disconnect the connector.) 4) Turn the ignition switch to ON. 5) Measure the voltage between G sensor connector terminals. Connector & terminal (B292) No. 1 (+) — No. 3 (-):	Go to step 4.	Repair the harness connector between G sensor and ABSCM&H/U.
4	CHECK OPEN CIRCUIT IN G SENSOR OUTPUT HARNESS AND GROUND HARNESS. 1) Turn the ignition switch to OFF. 2) Disconnect the connector from ABSCM&H/U. 3) Measure the resistance between ABSCM&H/U connector terminals. Connector & terminal LHD: (B301) No. 6 — No. 28: RHD: (F49) No. 6 — No. 28:	Go to step 5.	Repair the harness connector between G sensor and ABSCM&H/U.
5	CHECK GROUND SHORT IN G SENSOR OUTPUT HARNESS. 1) Disconnect the connector from G sensor. 2) Measure the resistance between ABSCM&H/U connector and chassis ground. Connector & terminal LHD: (B301) No. 6 — Chassis ground: RHD: (F49) No. 6 — Chassis ground:	Go to step 6.	Repair the harness between G sensor and ABSCM&H/U.
6	CHECK BATTERY SHORT OF HARNESS. Measure the voltage between ABSCM&H/U connector and chassis ground. Connector & terminal LHD: (B301) No. 6 (+) — Chassis ground (-): RHD: (F49) No. 6 (+) — Chassis ground (-):	Go to step 7.	Repair the harness between G sensor and ABSCM&H/U.
7	CHECK BATTERY SHORT OF HARNESS. 1) Turn the ignition switch to ON. 2) Measure the voltage between ABSCM&H/U connector and chassis ground. Connector & terminal LHD: (B301) No. 6 (+) — Chassis ground (-): RHD: (F49) No. 6 (+) — Chassis ground (-):	Go to step 8.	Repair the harness between G sensor and ABSCM&H/U.

Diagnostics Procedure without Diagnostic Trouble Code (DTC)

ABS (DIAGNOSTIC)

Step	Check	Yes	No
8 CHECK GROUND SHORT OF HARNESS. Measure the resistance between ABSCM&H/U connector and chassis ground. <i>Connector & terminal</i> <i>LHD: (B301) No. 28 — Chassis ground:</i> <i>RHD: (F49) No. 28 — Chassis ground:</i>	Is the resistance more than 1 MΩ?	Go to step 9.	Repair the harness between G sensor and ABSCM&H/U. Replace the ABSCM only. <Ref. to ABS-8, ABSCM (ABS CONTROL MODULE), REPLACE, ABS Control Module and Hydraulic Control Unit (ABSCM&H/U).>
9 CHECK G SENSOR. 1) Turn the ignition switch to OFF. 2) Remove the G sensor from vehicle. 3) Connect the connector to G sensor. 4) Connect the connector to ABSCM&H/U. 5) Turn the ignition switch to ON. 6) Measure the voltage between G sensor connector terminals. <i>Connector & terminal</i> <i>(B292) No. 2 (+) — No. 3 (-):</i>	Is the voltage 2.1 — 2.4 V when G sensor is in horizontal position?	Go to step 10.	Replace the G sensor. <Ref. to ABS-23, G Sensor.>
10 CHECK G SENSOR. Measure the voltage between G sensor connector terminals. <i>Connector & terminal</i> <i>(B292) No. 2 (+) — No. 3 (-):</i>	Is the voltage 3.7 — 4.1 V when G sensor is inclined forwards to 90°?	Go to step 11.	Replace the G sensor. <Ref. to ABS-23, G Sensor.>
11 CHECK G SENSOR. Measure the voltage between G sensor connector terminals. <i>Connector & terminal</i> <i>(B292) No. 2 (+) — No. 3 (-):</i>	Is the voltage 0.5 — 0.9 V when G sensor is inclined backwards to 90°?	Go to step 12.	Replace the G sensor. <Ref. to ABS-23, G Sensor.>
12 CHECK POOR CONTACT IN CONNECTORS.	Is there poor contact in connector between ABSCM&H/U and G sensor?	Repair the connector.	Go to step 13.
13 CHECK ABSCM&H/U. 1) Connect all connectors. 2) Erase the memory. 3) Perform inspection mode. 4) Read out the DTC.	Is the same DTC as in the current diagnosis still being output?	Replace the ABSCM only. <Ref. to ABS-8, ABSCM (ABS CONTROL MODULE), REPLACE, ABS Control Module and Hydraulic Control Unit (ABSCM&H/U).>	Go to step 14.
14 CHECK ANY OTHER DIAGNOSTIC TROUBLE CODES (DTCs) APPEARANCE.	Are other DTCs being output?	Proceed with the diagnosis corresponding to DTC.	A temporary poor contact.

Diagnostics Procedure with Diagnostic Trouble Code (DTC)

ABS (DIAGNOSTIC)

13. Diagnostics Procedure with Diagnostic Trouble Code (DTC)

A: COMMUNICATION FOR INITIALIZING IMPOSSIBLE

DIAGNOSIS:

Faulty harness connector

TROUBLE SYMPTOM:

ABS warning light remains on.

WIRING DIAGRAM:

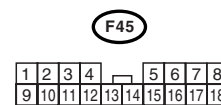
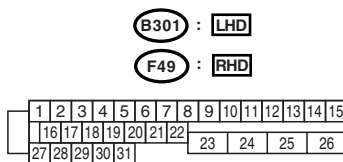
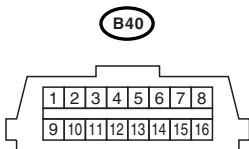
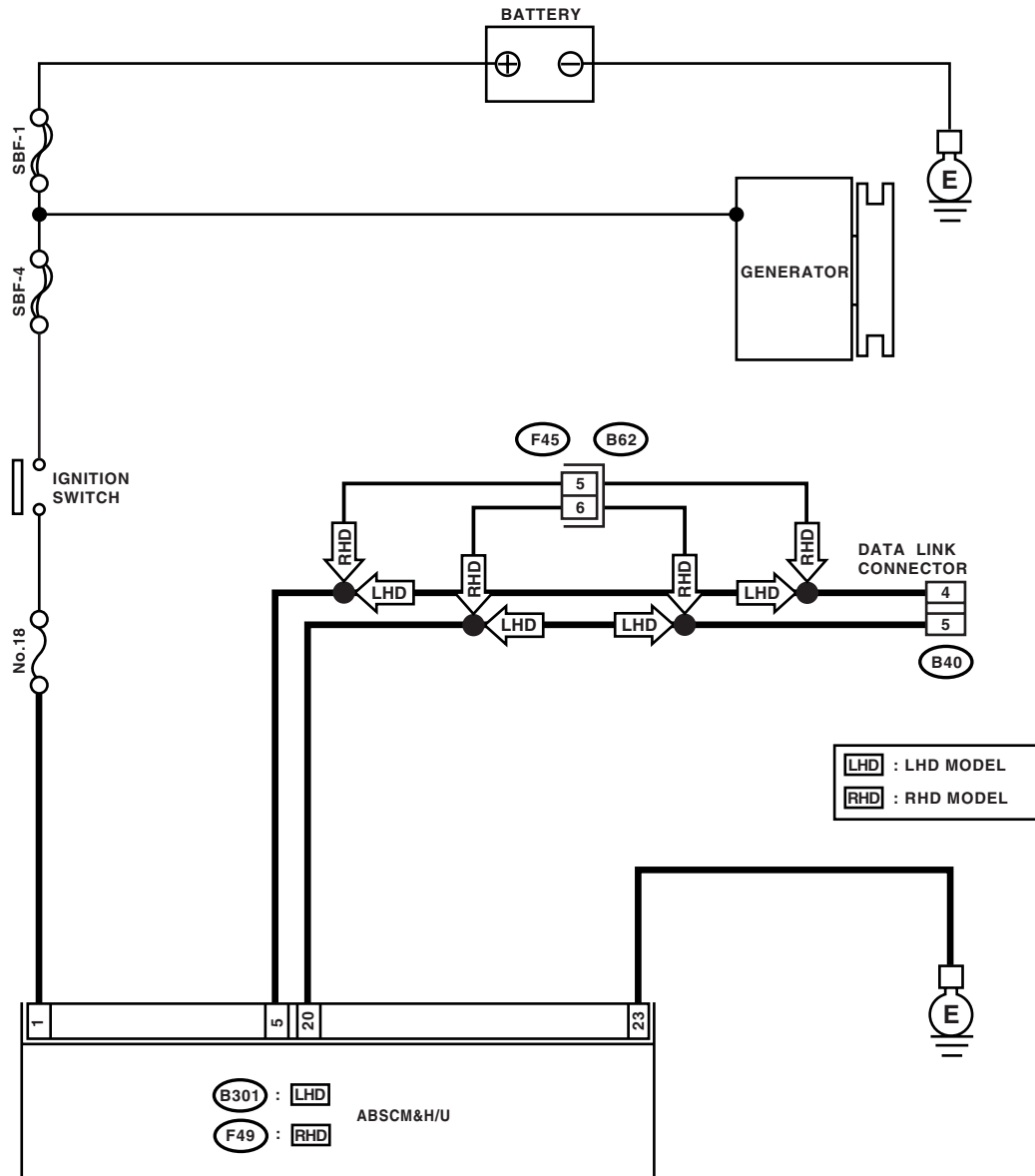

Diagnostics Procedure with Diagnostic Trouble Code (DTC)

ABS (DIAGNOSTIC)

Step	Check	Yes	No	
1	CHECK IGNITION SWITCH.	Is the ignition switch turned to ON?	Go to step 2.	Turn the ignition switch to ON, and select ABS mode using SUBARU select monitor.
2	CHECK BATTERY. 1) Turn the ignition switch to OFF. 2) Measure the battery voltage.	Is the voltage more than 11 V?	Go to step 3.	Charge or replace the battery.
3	CHECK BATTERY TERMINAL.	Is there poor contact at battery terminal?	Repair or tighten the battery terminal.	Go to step 4.
4	CHECK COMMUNICATION OF SELECT MONITOR. 1) Turn the ignition switch to ON. 2) Using the select monitor, check whether communication to other system can be executed normally.	Are the name and year of system displayed on select monitor?	Go to step 7.	Go to step 5.
5	CHECK COMMUNICATION OF SELECT MONITOR. 1) Turn the ignition switch to OFF. 2) Disconnect the ABSCM&H/U connector. 3) Turn the ignition switch to ON. 4) Check whether communication to other systems can be executed normally.	Are the name and year of system displayed on select monitor?	Go to step 7.	Go to step 6.
6	CHECK HARNESS CONNECTOR BETWEEN EACH CONTROL MODULE AND DATA LINK CONNECTOR. 1) Turn the ignition switch to OFF. 2) Disconnect the ABSCM&H/U, ECM and TCM connectors. 3) Measure the resistance between data link connector and chassis ground. Connector & terminal (B40) No. 5 — Chassis ground: (B40) No. 4 — Chassis ground:	Is the resistance more than 1 M Ω ?	Go to step 7.	Repair the harness and connector between each control module and data link connector.
7	CHECK OUTPUT SIGNAL FOR ABSCM&H/U. 1) Turn the ignition switch to ON. 2) Measure the voltage between ABSCM&H/U and chassis ground. Connector & terminal (B40) No. 5 (+) — Chassis ground (-): (B40) No. 4 (+) — Chassis ground (-):	Is the voltage less than 1 V?	Go to step 8.	Repair the harness and connector between each control module and data link connector.
8	CHECK HARNESS/CONNECTOR BETWEEN ABSCM&H/U AND DATA LINK CONNECTOR. Measure the resistance between ABSCM&H/U connector and data link connector. Connector & terminal LHD: (B301) No. 20 — (B40) No. 5: (B301) No. 5 — (B40) No. 4: RHD: (F49) No. 20 — (B40) No. 5: (F49) No. 5 — (B40) No. 4:	Is the resistance less than 0.5 Ω ?	Go to step 9.	Repair the harness and connector between ABSCM&H/U and data link connector.
9	CHECK INSTALLATION OF ABSCM&H/U CONNECTOR. Turn the ignition switch to OFF.	Is the ABSCM&H/U connector inserted into ABSCM&H/U until the clamp locks onto it?	Go to step 10.	Insert the ABSCM&H/U connector into ABSCM&H/U.

Diagnostics Procedure with Diagnostic Trouble Code (DTC)

ABS (DIAGNOSTIC)

Step	Check	Yes	No
10 CHECK POWER SUPPLY CIRCUIT. 1) Turn the ignition switch to ON (engine OFF). 2) Measure the ignition power supply voltage between ABSCM&H/U connector and chassis ground. <i>Connector & terminal</i> <i>LHD: (B301) No. 1 (+) — Chassis ground (-):</i> <i>RHD: (F49) No. 1 (+) — Chassis ground (-):</i>	Is the voltage more than 10 V?	Go to step 11.	Repair the open circuit in harness between ABSCM&H/U and battery.
11 CHECK HARNESS CONNECTOR BETWEEN ABSCM&H/U AND CHASSIS GROUND. 1) Turn the ignition switch to OFF. 2) Disconnect the connector from ABSCM&H/U and transmission. 3) Measure the resistance of harness between ABSCM&H/U and chassis ground. <i>Connector & terminal</i> <i>LHD: (B301) No. 23 — Chassis ground:</i> <i>RHD: (F49) No. 23 — Chassis ground:</i>	Is the resistance less than 1 Ω ?	Go to step 12.	Repair the open circuit in harness between ABSCM&H/U and inhibitor side connector, and poor contact in coupling connector.
12 CHECK POOR CONTACT IN CONNECTORS.	Is there poor contact in control module power supply, ground line and data link connector?	Repair the connector.	Replace the ABSCM only. <Ref. to ABS-8, ABSCM (ABS CONTROL MODULE), REPLACE, ABS Control Module and Hydraulic Control Unit (ABSCM&H/U).>

B: NO TROUBLE CODE

DIAGNOSIS:

ABS warning light circuit is shorted.

TROUBLE SYMPTOM:

- ABS warning light remains on.
- NO TROUBLE CODE displayed on the select monitor.

NOTE:

When the ABS warning light is OFF and “NO TROUBLE CODE” is displayed on select monitor, the system is in normal condition.

Diagnostics Procedure with Diagnostic Trouble Code (DTC)

ABS (DIAGNOSTIC)

WIRING DIAGRAM:

- LHD model

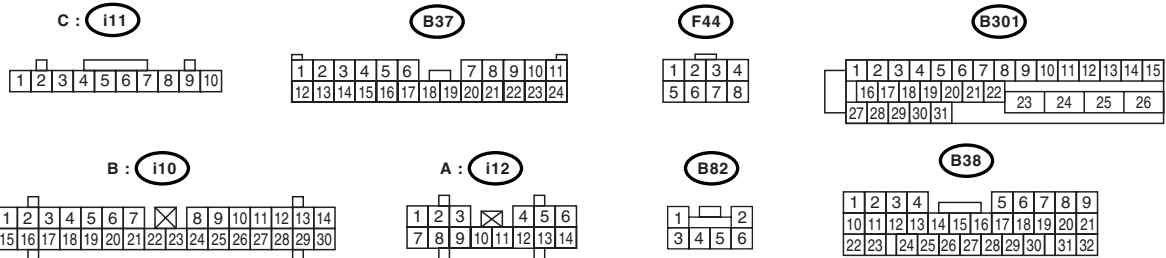
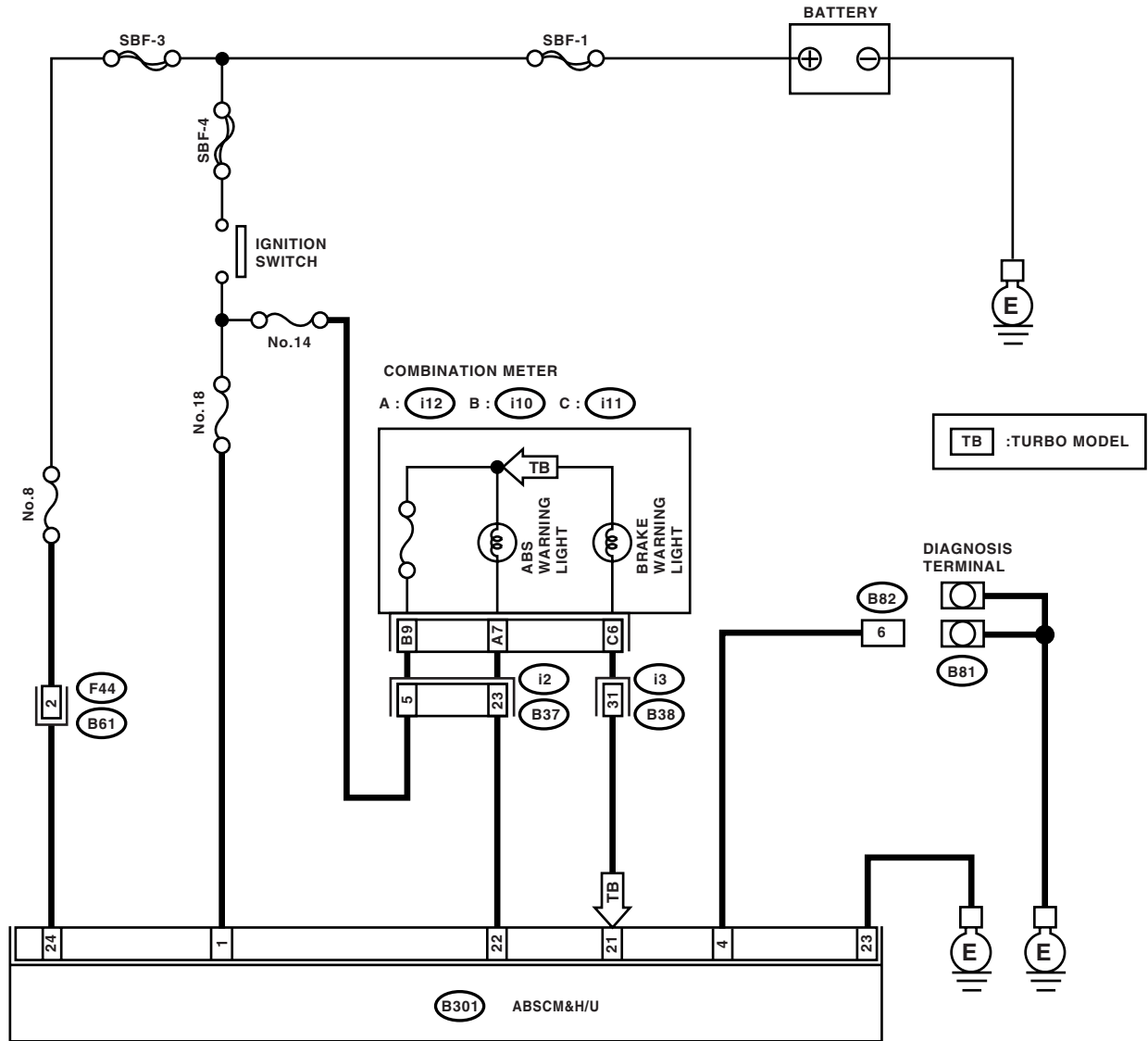

ABS00451

Diagnostics Procedure with Diagnostic Trouble Code (DTC)

ABS (DIAGNOSTIC)

- RHD model

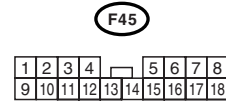
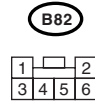
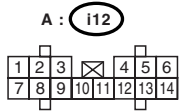
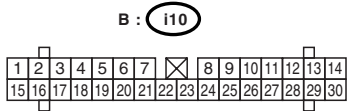
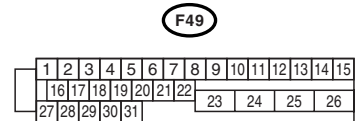
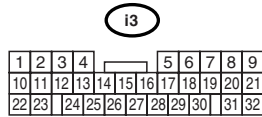
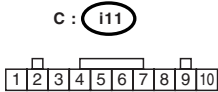
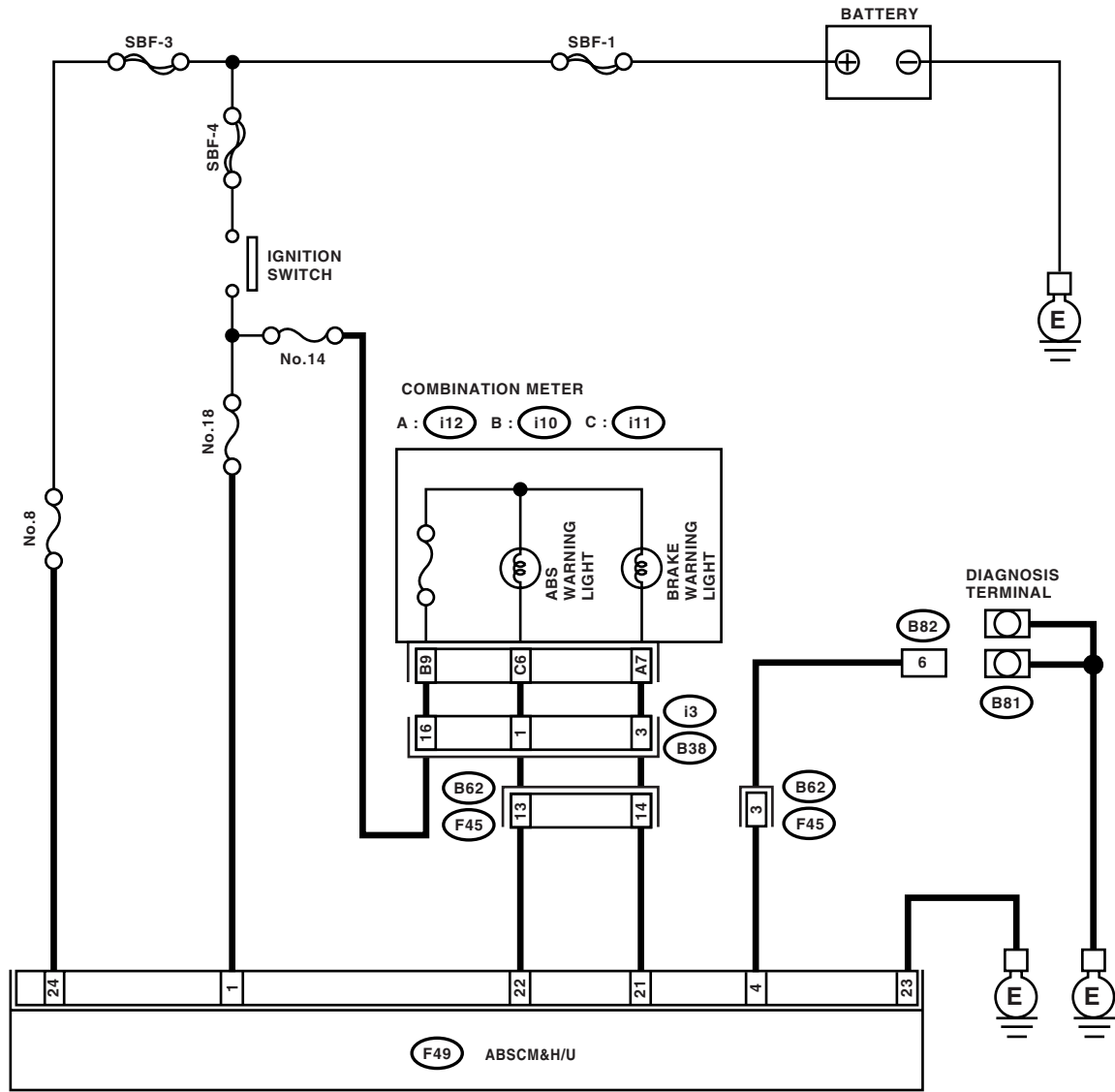

ABS00452

Diagnostics Procedure with Diagnostic Trouble Code (DTC)

ABS (DIAGNOSTIC)

Step	Check	Yes	No
1 CHECK WIRING HARNESS. 1) Turn the ignition switch to OFF. 2) Disconnect the connector (B38) from connector (i3). 3) Turn ignition switch to ON.	Does the ABS warning light turn on?	Go to step 2.	Repair the front wiring harness.
2 CHECK PROJECTION AT ABSCM&H/U. 1) Turn the ignition switch to OFF. 2) Disconnect the connector from ABSCM&H/U.	Is there any damage on projection?	Replace the ABSCM only. <Ref. to ABS-8, ABSCM (ABS CONTROL MODULE), REPLACE, ABS Control Module and Hydraulic Control Unit (ABSCM&H/U).>	Go to step 3.
3 CHECK ABSCM&H/U. Measure the resistance between ABSCM&H/U terminals. Terminals No. 22 — No. 23:	Is the resistance more than 1 M Ω ?	Go to step 4.	Replace the ABSCM only. <Ref. to ABS-8, ABSCM (ABS CONTROL MODULE), REPLACE, ABS Control Module and Hydraulic Control Unit (ABSCM&H/U).>
4 CHECK WIRING HARNESS. Measure the resistance between connector and chassis ground. Connector & terminal LHD: (B301) No. 22 — Chassis ground: RHD: (F49) No. 22 — Chassis ground:	Is the resistance less than 0.5 Ω ?	Go to step 5.	Repair the harness.
5 CHECK WIRING HARNESS. 1) Connect the connector to ABSCM&H/U. 2) Measure the resistance between connector and chassis ground. Connector & terminal LHD: (B301) No. 22 — Chassis ground: RHD: (F49) No. 22 — Chassis ground:	Is the resistance more than 1 M Ω ?	Go to step 6.	Repair the harness.
6 CHECK POOR CONTACT IN ABSCM&H/U CONNECTOR.	Is there poor contact in ABSCM&H/U connector?	Repair the connector.	Replace the ABSCM only. <Ref. to ABS-8, ABSCM (ABS CONTROL MODULE), REPLACE, ABS Control Module and Hydraulic Control Unit (ABSCM&H/U).>

C: DTC 21 OPEN OR SHORT CIRCUIT IN FRONT RIGHT ABS SENSOR CIRCUIT

NOTE:

For the diagnostic procedure, refer to DTC 27. <Ref. to ABS-102, DTC 27 OPEN OR SHORT CIRCUIT IN REAR LEFT ABS SENSOR CIRCUIT, Diagnosics Procedure with Diagnostic Trouble Code (DTC).>

D: DTC 23 OPEN OR SHORT CIRCUIT IN FRONT LEFT ABS SENSOR CIRCUIT

NOTE:

For the diagnostic procedure, refer to DTC 27. <Ref. to ABS-102, DTC 27 OPEN OR SHORT CIRCUIT IN REAR LEFT ABS SENSOR CIRCUIT, Diagnosics Procedure with Diagnostic Trouble Code (DTC).>

E: DTC 25 OPEN OR SHORT CIRCUIT IN REAR RIGHT ABS SENSOR CIRCUIT

NOTE:

For the diagnostic procedure, refer to DTC 27. <Ref. to ABS-102, DTC 27 OPEN OR SHORT CIRCUIT IN REAR LEFT ABS SENSOR CIRCUIT, Diagnosics Procedure with Diagnostic Trouble Code (DTC).>

Diagnostics Procedure with Diagnostic Trouble Code (DTC)

ABS (DIAGNOSTIC)

F: DTC 27 OPEN OR SHORT CIRCUIT IN REAR LEFT ABS SENSOR CIRCUIT

DIAGNOSIS:

- Faulty ABS wheel speed sensor (Broken wire, input voltage too high)
- Faulty harness connector

TROUBLE SYMPTOM:

ABS does not operate.

Diagnostics Procedure with Diagnostic Trouble Code (DTC)

ABS (DIAGNOSTIC)

WIRING DIAGRAM:

- LHD model

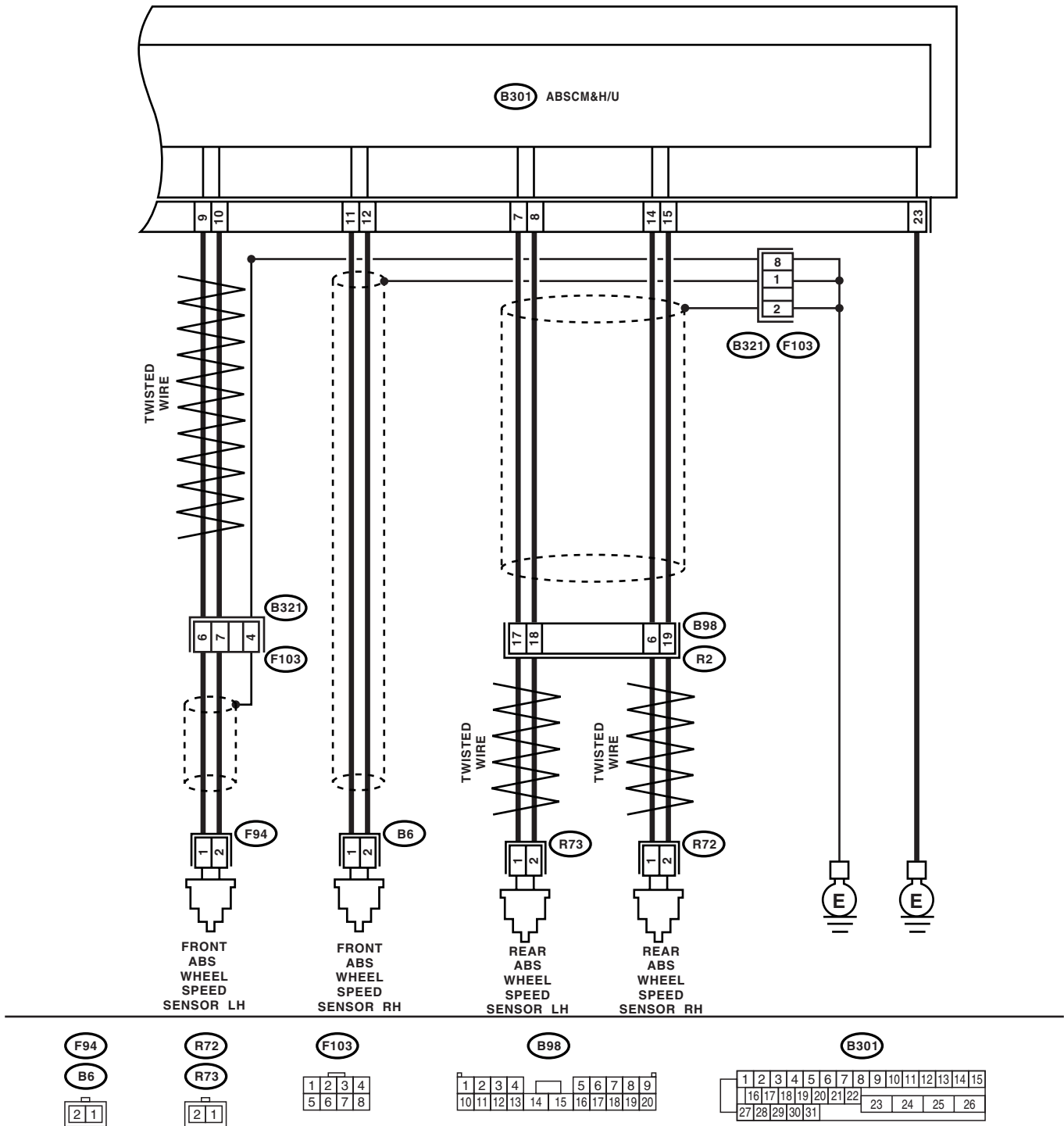

ABS00454

Diagnostics Procedure with Diagnostic Trouble Code (DTC)

ABS (DIAGNOSTIC)

- RHD model

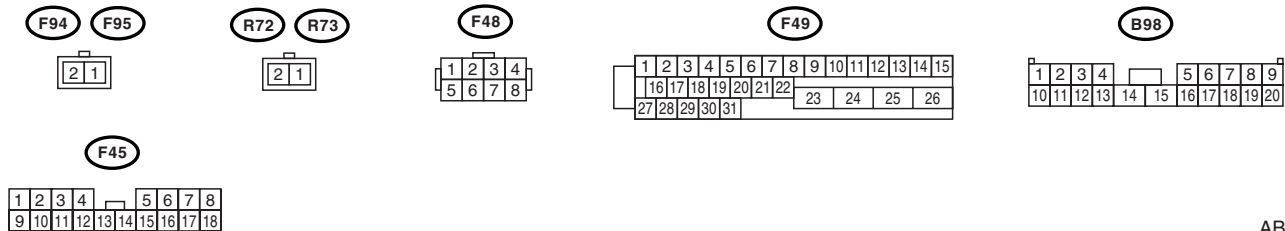
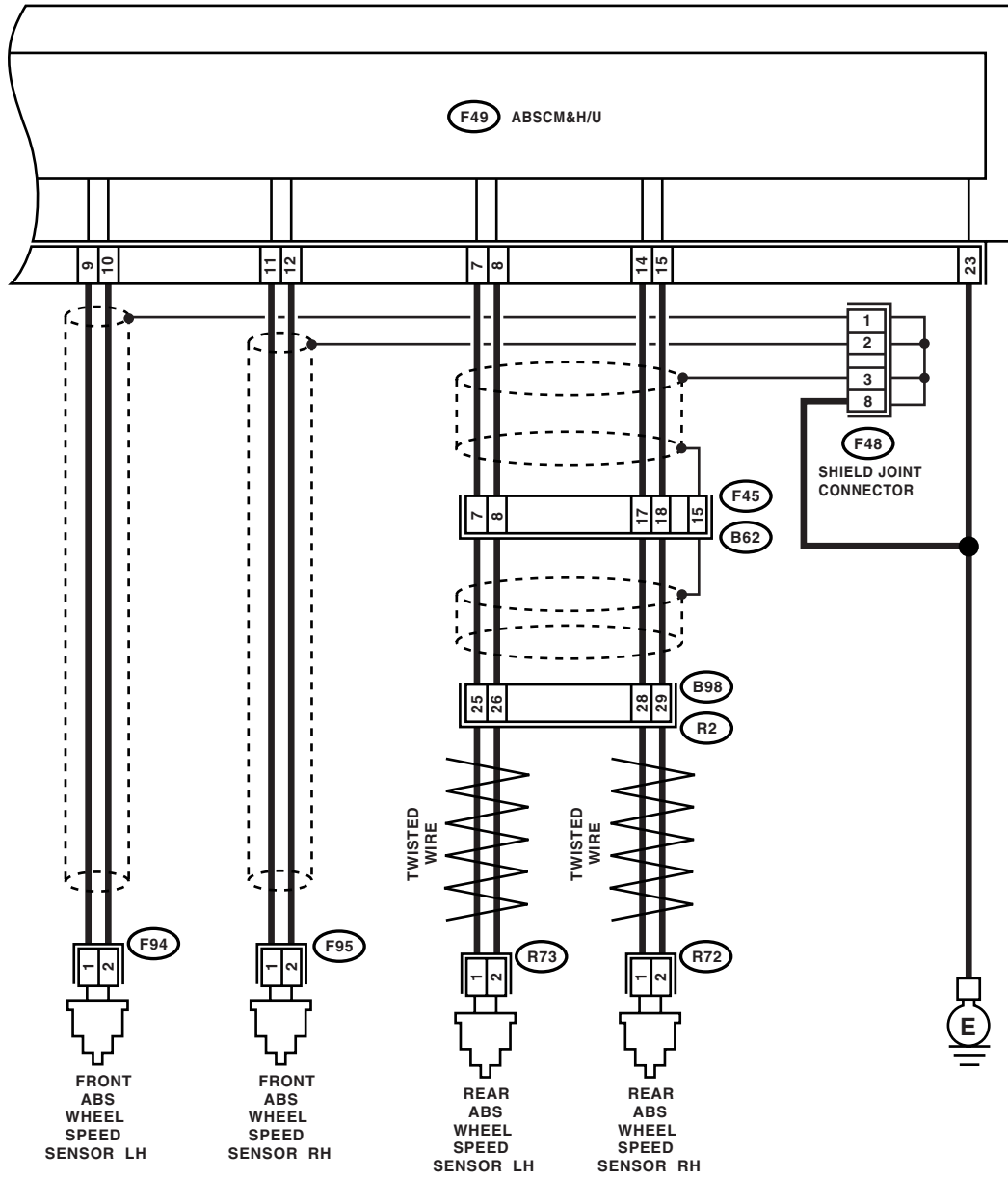

ABS00467

Diagnostics Procedure with Diagnostic Trouble Code (DTC)

ABS (DIAGNOSTIC)

Step	Check	Yes	No
1 CHECK OUTPUT OF ABS WHEEL SPEED SENSOR USING SELECT MONITOR. 1) Select "Current data display & Save" on the select monitor. 2) Read the ABS wheel speed sensor output corresponding to faulty system in the select monitor data display mode.	Does the speed indicated on display change in response to speedometer reading during acceleration/deceleration when the steering wheel is in straight-ahead position?	Go to step 2.	Go to step 8.
2 CHECK INSTALLATION OF ABS WHEEL SPEED SENSOR.	Are the ABS wheel speed sensor installation bolts tightened 33 N·m (3.4 kgf-m, 24.6 ft-lb)?	Go to step 3.	Tighten the ABS wheel speed sensor installation bolts securely.
3 CHECK ABS WHEEL SPEED SENSOR GAP. Measure the tone wheel to ABS wheel speed sensor piece gap over entire perimeter of the wheel.	Is the gap the following value? Front wheel: 0.3 — 0.8 mm (0.012 — 0.031 in) Rear wheel 0.7 — 1.2 mm (0.028 — 0.047 in)	Go to step 4.	Adjust the gap. NOTE: Adjust the gap using spacers (Part No. 26755AA000). If the spacers cannot correct gap, replace worn ABS wheel speed sensor or worn tone wheel.
4 CHECK TONE WHEEL RUNOUT. Measure the tone wheel runout.	Is the runout less than 0.05 mm (0.0020 in)?	Go to step 5.	Replace the tone wheel. Front: <Ref. to ABS-21, Front Tone Wheel.> Rear: <Ref. to ABS-22, Rear Tone Wheel.>
5 CHECK POOR CONTACT IN CONNECTORS. Turn the ignition switch to OFF.	Is there poor contact in connectors between ABSCM&H/U and ABS wheel speed sensor?	Repair the connector.	Go to step 6.
6 CHECK ABSCM&H/U. 1) Connect all connectors. 2) Erase the memory. 3) Perform the inspection mode. 4) Read out the DTC.	Is the same DTC as in the current diagnosis still being output?	Replace the ABSCM only. <Ref. to ABS-8, ABSCM (ABS CONTROL MODULE), REPLACE, ABS Control Module and Hydraulic Control Unit (ABSCM&H/U).>	Go to step 7.
7 CHECK ANY OTHER DIAGNOSTIC TROUBLE CODES (DTCs) APPEARANCE.	Are other DTCs being output?	Proceed with the diagnosis corresponding to DTC.	A temporary poor contact. NOTE: Check the harness and connectors between ABSCM&H/U and ABS wheel speed sensor.

Diagnostics Procedure with Diagnostic Trouble Code (DTC)

ABS (DIAGNOSTIC)

Step	Check	Yes	No
<p>8 CHECK ABS WHEEL SPEED SENSOR.</p> <p>1) Turn the ignition switch to OFF.</p> <p>2) Disconnect the connector from ABS wheel speed sensor.</p> <p>3) Measure the resistance of ABS wheel speed sensor connector terminals while shaking the harness lightly.</p> <p>Terminal</p> <p>Front RH No. 1 — No. 2:</p> <p>Front LH No. 1 — No. 2:</p> <p>Rear RH No. 1 — No. 2:</p> <p>Rear LH No. 1 — No. 2:</p>	<p>Is the resistance the following value?</p> <p>Front: 1 — 1.5 kΩ</p> <p>Rear: 1.025 — 1.265 kΩ</p>	Go to step 9.	<p>Replace the ABS wheel speed sensor. Front: <Ref. to ABS-15, Front ABS Wheel Speed Sensor.> Rear: <Ref. to ABS-18, Rear ABS Wheel Speed Sensor.></p>
<p>9 CHECK BATTERY SHORT OF ABS WHEEL SPEED SENSOR.</p> <p>1) Disconnect the connector from ABSCM&H/U.</p> <p>2) Measure the voltage between ABS wheel speed sensor and chassis ground.</p> <p>Terminal</p> <p>Front RH No. 1 (+) — Chassis ground (-):</p> <p>Front LH No. 1 (+) — Chassis ground (-):</p> <p>Rear RH No. 1 (+) — Chassis ground (-):</p> <p>Rear LH No. 1 (+) — Chassis ground (-):</p>	Is the voltage less than 1 V?	Go to step 10.	<p>Replace the ABS wheel speed sensor. Front: <Ref. to ABS-15, Front ABS Wheel Speed Sensor.> Rear: <Ref. to ABS-18, Rear ABS Wheel Speed Sensor.></p>
<p>10 CHECK BATTERY SHORT OF ABS WHEEL SPEED SENSOR.</p> <p>1) Turn the ignition switch to ON.</p> <p>2) Measure the voltage between ABS wheel speed sensor and chassis ground.</p> <p>Terminal</p> <p>Front RH No. 1 (+) — Chassis ground (-):</p> <p>Front LH No. 1 (+) — Chassis ground (-):</p> <p>Rear RH No. 1 (+) — Chassis ground (-):</p> <p>Rear LH No. 1 (+) — Chassis ground (-):</p>	Is the voltage less than 1 V?	Go to step 11.	<p>Replace the ABS wheel speed sensor. Front: <Ref. to ABS-15, Front ABS Wheel Speed Sensor.> Rear: <Ref. to ABS-18, Rear ABS Wheel Speed Sensor.></p>
<p>11 CHECK HARNESS/CONNECTOR BETWEEN ABSCM&H/U AND ABS WHEEL SPEED SENSOR.</p> <p>1) Turn the ignition switch to OFF.</p> <p>2) Connect the connector to ABS wheel speed sensor.</p> <p>3) Measure the resistance between ABSCM&H/U connector terminals.</p> <p>Connector & terminal</p> <p>DTC 21</p> <p>LHD: (B301) No. 11 — No. 12:</p> <p>RHD: (F49) No. 11 — No. 12:</p> <p>DTC 23</p> <p>LHD: (B301) No. 9 — No. 10:</p> <p>RHD: (F49) No. 9 — No. 10:</p> <p>DTC 25</p> <p>LHD: (B301) No. 14 — No. 15:</p> <p>RHD: (F49) No. 14 — No. 15:</p> <p>DTC 27</p> <p>LHD: (B301) No. 7 — No. 8:</p> <p>RHD: (F49) No. 7 — No. 8:</p>	<p>Is the resistance the following value?</p> <p>Front: 1 — 1.5 kΩ</p> <p>Rear: 1.025 — 1.265 kΩ</p>	Go to step 12.	<p>Repair the harness/connector between ABSCM&H/U and ABS wheel speed sensor.</p>

Diagnostics Procedure with Diagnostic Trouble Code (DTC)

ABS (DIAGNOSTIC)

Step	Check	Yes	No
<p>12 CHECK BATTERY SHORT OF HARNESS. Measure the voltage between ABSCM&H/U connector and chassis ground. <i>Connector & terminal</i> DTC 21 <i>LHD: (B301) No. 11 (+) — Chassis ground (-):</i> <i>RHD: (F49) No. 11 (+) — Chassis ground (-):</i> DTC 23 <i>LHD: (B301) No. 9 (+) — Chassis ground (-):</i> <i>RHD: (F49) No. 9 (+) — Chassis ground (-):</i> DTC 25 <i>LHD: (B301) No. 14 (+) — Chassis ground (-):</i> <i>RHD: (F49) No. 14 (+) — Chassis ground (-):</i> DTC 27 <i>LHD: (B301) No. 7 (+) — Chassis ground (-):</i> <i>RHD: (F49) No. 7 (+) — Chassis ground (-):</i></p>	<p>Is the voltage less than 1 V?</p>	<p>Go to step 13.</p>	<p>Repair the harness between ABSCM&H/U and ABS wheel speed sensor.</p>
<p>13 CHECK BATTERY SHORT OF HARNESS. 1) Turn the ignition switch to ON. 2) Measure the voltage between ABSCM&H/U connector and chassis ground. <i>Connector & terminal</i> DTC 21 <i>LHD: (B301) No. 11 (+) — Chassis ground (-):</i> <i>RHD: (F49) No. 11 (+) — Chassis ground (-):</i> DTC 23 <i>LHD: (B301) No. 9 (+) — Chassis ground (-):</i> <i>RHD: (F49) No. 9 (+) — Chassis ground (-):</i> DTC 25 <i>LHD: (B301) No. 14 (+) — Chassis ground (-):</i> <i>RHD: (F49) No. 14 (+) — Chassis ground (-):</i> DTC 27 <i>LHD: (B301) No. 7 (+) — Chassis ground (-):</i> <i>RHD: (F49) No. 7 (+) — Chassis ground (-):</i></p>	<p>Is the voltage less than 1 V?</p>	<p>Go to step 14.</p>	<p>Repair the harness between ABSCM&H/U and ABS wheel speed sensor.</p>
<p>14 CHECK INSTALLATION OF ABS WHEEL SPEED SENSOR.</p>	<p>Are the ABS wheel speed sensor installation bolts tightened 33 N·m (3.4 kgf·m, 24.6 ft·lb)?</p>	<p>Go to step 15.</p>	<p>Tighten the ABS wheel speed sensor installation bolts securely.</p>

Diagnostics Procedure with Diagnostic Trouble Code (DTC)

ABS (DIAGNOSTIC)

Step	Check	Yes	No
15 CHECK ABS WHEEL SPEED SENSOR GAP. Measure the tone wheel to ABS wheel speed sensor piece gap over entire perimeter of the wheel.	Is the gap the following value? Front wheel: 0.3 — 0.8 mm (0.012 — 0.031 in) Rear wheel: 0.7 — 1.2 mm (0.028 — 0.047 in)	Go to step 16.	Adjust the gap. NOTE: Adjust the gap using spacers (Part No. 26755AA000). If the spacers cannot correct gap, replace worn ABS wheel speed sensor or worn tone wheel.
16 CHECK TONE WHEEL RUNOUT. Measure the tone wheel runout.	Is the runout less than 0.05 mm (0.0020 in)?	Go to step 17.	Replace the tone wheel. Front: <Ref. to ABS-21, Front Tone Wheel.> Rear: <Ref. to ABS-22, Rear Tone Wheel.>
17 CHECK GROUND SHORT OF ABS WHEEL SPEED SENSOR. 1) Turn the ignition switch to ON. 2) Measure the resistance between ABS wheel speed sensor and chassis ground. <i>Terminal</i> <i>Front RH No. 1 — Chassis ground:</i> <i>Front LH No. 1 — Chassis ground:</i> <i>Rear RH No. 1 — Chassis ground:</i> <i>Rear LH No. 1 — Chassis ground:</i>	Is the resistance more than 1 M Ω ?	Go to step 18.	Replace the ABS wheel speed sensor and ABSCM only. Front: <Ref. to ABS-15, Front ABS Wheel Speed Sensor.> Rear: <Ref. to ABS-18, Rear ABS Wheel Speed Sensor.> <Ref. to ABS-8, ABSCM (ABS CONTROL MODULE), REPLACE, ABS Control Module and Hydraulic Control Unit (ABSCM&H/U).>
18 CHECK GROUND SHORT OF HARNESS. 1) Turn the ignition switch to OFF. 2) Connect the connector to ABS wheel speed sensor. 3) Measure the resistance between ABSCM&H/U connector terminal and chassis ground. <i>Connector & terminal</i> <i>DTC 21</i> <i>LHD: (B301) No. 11 — Chassis ground:</i> <i>RHD: (F49) No. 11 — Chassis ground:</i> <i>DTC 23</i> <i>LHD: (B301) No. 9 — Chassis ground:</i> <i>RHD: (F49) No. 9 — Chassis ground:</i> <i>DTC 25</i> <i>LHD: (B301) No. 14 — Chassis ground:</i> <i>RHD: (F49) No. 14 — Chassis ground:</i> <i>DTC 27</i> <i>LHD: (B301) No. 7 — Chassis ground:</i> <i>RHD: (F49) No. 7 — Chassis ground:</i>	Is the resistance more than 1 M Ω ?	Go to step 19.	Repair the harness between ABSCM&H/U and ABS wheel speed sensor. And replace the ABSCM only. <Ref. to ABS-8, ABSCM (ABS CONTROL MODULE), REPLACE, ABS Control Module and Hydraulic Control Unit (ABSCM&H/U).>
19 CHECK POOR CONTACT IN CONNECTORS.	Is there poor contact in connectors between ABSCM&H/U and ABS wheel speed sensor?	Repair the connector.	Go to step 20.

Diagnosics Procedure with Diagnostic Trouble Code (DTC)

ABS (DIAGNOSTIC)

Step	Check	Yes	No
20 CHECK ABSCM&H/U. 1) Connect all connectors. 2) Erase the memory. 3) Perform the inspection mode. 4) Read out the DTC.	Is the same DTC as in current diagnosis still being output?	Replace the ABSCM only.	Go to step 21.
21 CHECK ANY OTHER DIAGNOSTIC TROUBLE CODES (DTCs) APPEARANCE.	Are other DTCs being output?	Proceed with the diagnosis corresponding to DTC.	A temporary poor contact. NOTE: Check the harness and connectors between AB-SCM&H/U and ABS wheel speed sensor.

Diagnostics Procedure with Diagnostic Trouble Code (DTC)

ABS (DIAGNOSTIC)

G: DTC 22 FRONT RIGHT ABNORMAL ABS SENSOR SIGNAL

NOTE:

For the diagnostic procedure, refer to DTC 28. <Ref. to ABS-111, DTC 28 REAR LEFT ABNORMAL ABS SENSOR SIGNAL, Diagnostics Procedure with Diagnostic Trouble Code (DTC).>

H: DTC 24 FRONT LEFT ABNORMAL ABS SENSOR SIGNAL

NOTE:

For the diagnostic procedure, refer to DTC 28. <Ref. to ABS-111, DTC 28 REAR LEFT ABNORMAL ABS SENSOR SIGNAL, Diagnostics Procedure with Diagnostic Trouble Code (DTC).>

I: DTC 26 REAR RIGHT ABNORMAL ABS SENSOR SIGNAL

NOTE:

For the diagnostic procedure, refer to DTC 28. <Ref. to ABS-111, DTC 28 REAR LEFT ABNORMAL ABS SENSOR SIGNAL, Diagnostics Procedure with Diagnostic Trouble Code (DTC).>

J: DTC 28 REAR LEFT ABNORMAL ABS SENSOR SIGNAL

DIAGNOSIS:

- Faulty ABS wheel speed sensor signal (noise, irregular signal, etc.)
- Faulty harness/connector

TROUBLE SYMPTOM:

ABS does not operate.

WIRING DIAGRAM:

- LHD model

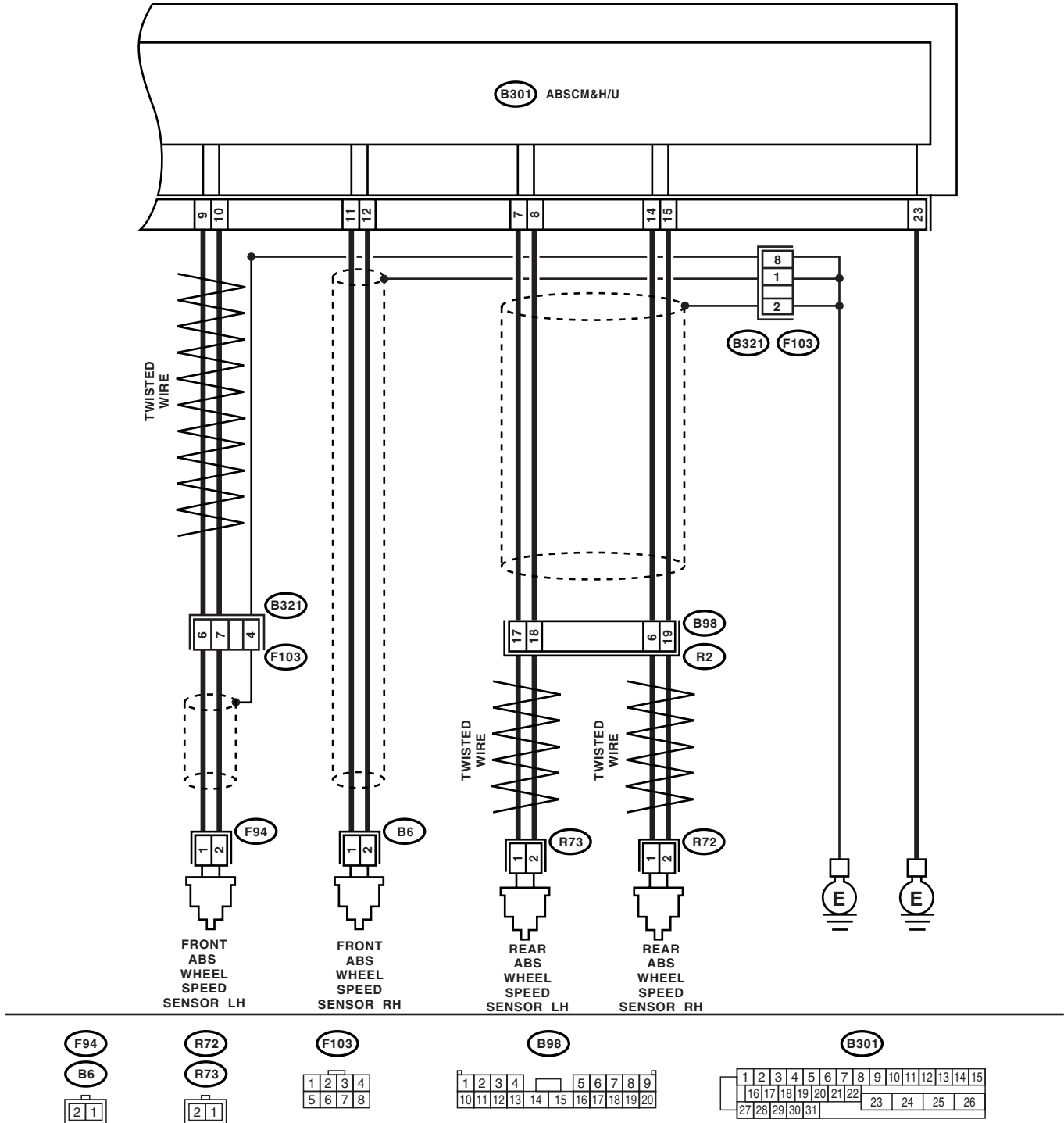

Diagnostics Procedure with Diagnostic Trouble Code (DTC)

ABS (DIAGNOSTIC)

- RHD model

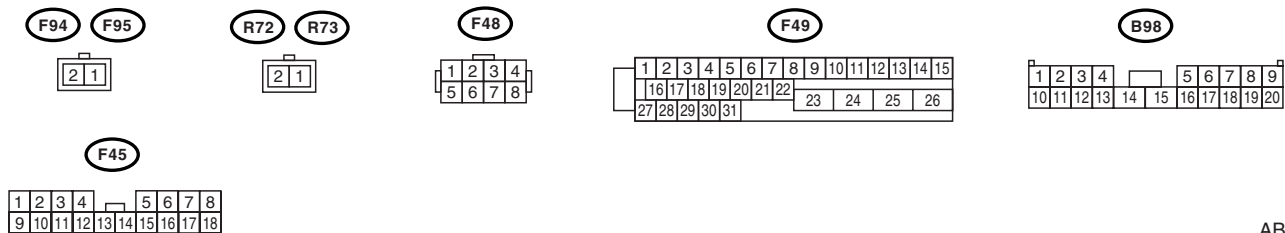
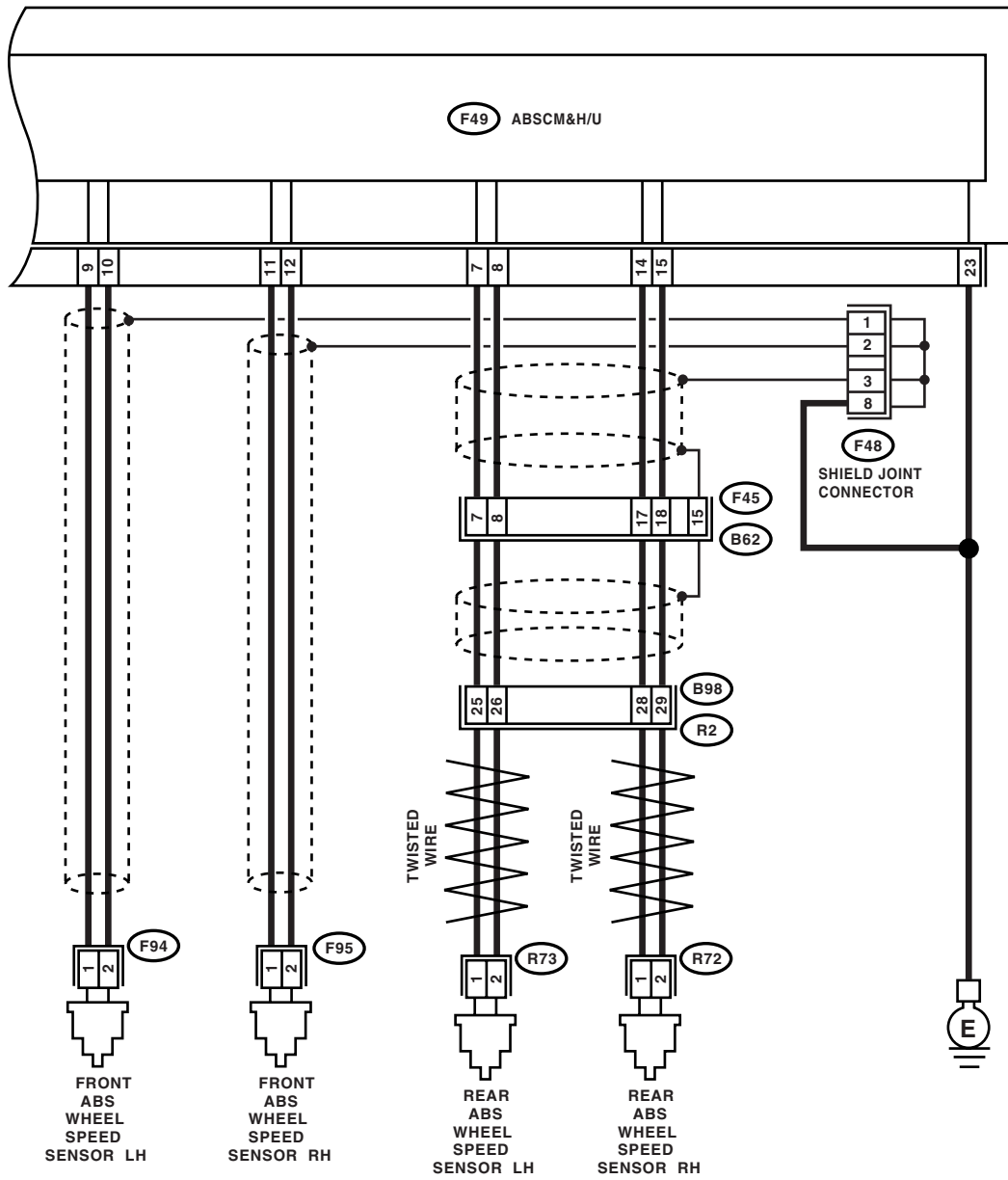

ABS00467

Diagnostics Procedure with Diagnostic Trouble Code (DTC)

ABS (DIAGNOSTIC)

Step	Check	Yes	No
1 CHECK OUTPUT OF ABS WHEEL SPEED SENSOR USING SELECT MONITOR. 1) Select "Current data display & Save" on the select monitor. 2) Read the ABS wheel speed sensor output corresponding to faulty system in the select monitor data display mode.	Does the speed indicated on display change in response to speedometer reading during acceleration/deceleration when the steering wheel is in straight-ahead position?	Go to step 2.	Go to step 8.
2 CHECK POOR CONTACT IN CONNECTORS. Turn the ignition switch to OFF.	Is there poor contact in connectors between ABSCM&H/U and ABS wheel speed sensor?	Repair the connector.	Go to step 3.
3 CHECK SOURCES OF SIGNAL NOISE.	Is the car telephone or wireless transmitter properly installed?	Go to step 4.	Properly install the car telephone or wireless transmitter.
4 CHECK SOURCES OF SIGNAL NOISE.	Are noise sources (such as an antenna) installed near the sensor harness?	Install the noise sources apart from sensor harness.	Go to step 5.
5 CHECK SHIELD CIRCUIT. 1) Turn the ignition switch to OFF. 2) Connect all connectors. 3) Measure the resistance between shield connector and chassis ground. Connector & terminal DTC 22 <i>LHD: (F103) No. 1 — Chassis ground:</i> <i>RHD: (F48) No. 2 — Chassis ground:</i> DTC 24 <i>LHD: (F103) No. 8 — Chassis ground:</i> <i>RHD: (F48) No. 1 — Chassis ground:</i> DTC 26 <i>LHD: (F103) No. 2 — Chassis ground:</i> <i>RHD: (F48) No. 3 — Chassis ground:</i> DTC 28 <i>LHD: (F103) No. 2 — Chassis ground:</i> <i>RHD: (F48) No. 3 — Chassis ground:</i>	Is the resistance less than 0.5 Ω ?	Go to step 6.	Repair the shield harness.
6 CHECK ABSCM&H/U. 1) Connect all connectors. 2) Erase the memory. 3) Perform the inspection mode. 4) Read out the DTC.	Is the same DTC as in the current diagnosis still being output?	Replace the ABSCM only. <Ref. to ABS-8, ABSCM (ABS CONTROL MODULE), REPLACE, ABS Control Module and Hydraulic Control Unit (ABSCM&H/U).>	Go to step 7.
7 CHECK ANY OTHER DIAGNOSTIC TROUBLE CODES (DTCs) APPEARANCE.	Are other DTCs being output?	Proceed with the diagnosis corresponding to DTC.	A temporary noise interference.
8 CHECK INSTALLATION OF ABS WHEEL SPEED SENSOR.	Are the ABS wheel speed sensor installation bolts tightened 33 N·m (3.4 kgf-m, 24.6 ft-lb)?	Go to step 9.	Tighten the ABS wheel speed sensor installation bolts securely.

Diagnostics Procedure with Diagnostic Trouble Code (DTC)

ABS (DIAGNOSTIC)

Step	Check	Yes	No
9 CHECK ABS WHELL SPEED SENSOR GAP. Measure the tone wheel to ABS wheel speed sensor piece gap over entire perimeter of wheel.	Is the gap the following value? Front wheel: 0.3 — 0.8 mm (0.012 — 0.031 in) Rear wheel: 0.7 — 1.2 mm (0.028 — 0.047 in)	Go to step 10.	Adjust the gap. NOTE: Adjust the gap using spacer (Part No. 26755AA000). If the spacers cannot correct gap, replace worn ABS wheel speed sensor or worn tone wheel.
10 PREPARE OSCILLOSCOPE.	Is an oscilloscope available?	Go to step 11.	Go to step 12.
11 CHECK ABS WHEEL SPEED SENSOR SIGNAL. 1) Raise all four wheels off ground. 2) Turn the ignition switch to OFF. 3) Connect the oscilloscope to the connector. 4) Turn the ignition switch to ON. 5) Rotate the wheels and measure voltage at specified frequency. <Ref. to ABS-17, WAVEFORM, Control Module I/O Signal.> NOTE: When this inspection is completed, the ABS-CM&H/U sometimes stores DTC 29 or DTC 56. Connector & terminal DTC 22 <i>LHD: (B6) No. 1 (+) — No. 2 (-):</i> <i>RHD: (F95) No. 1 (+) — No. 2 (-):</i> DTC 24 <i>LHD: (F103) No. 6 (+) — No. 7 (-):</i> <i>RHD: (F94) No. 1 (+) — No. 2 (-):</i> DTC 26 <i>LHD: (B98) No. 6 (+) — No. 19 (-):</i> <i>RHD: (B98) No. 28 (+) — No. 29 (-):</i> DTC 28 <i>LHD: (B98) No. 17 (+) — No. 18 (-):</i> <i>RHD: (B98) No. 25 (+) — No. 26 (-):</i>	Is oscilloscope pattern as shown in the figure? <Ref. to ABS-17, WAVEFORM, Control Module I/O Signal.>	Go to step 15.	Go to step 12.
12 CHECK CONTAMINATION OF ABS WHEEL SPEED SENSOR OR TONE WHEEL. Remove the disc rotor or drum from hub in accordance with DTC.	Is the ABS wheel speed sensor piece or tone wheel contaminated by dirt or other foreign matter?	Thoroughly remove dirt or other foreign matter.	Go to step 13.
13 CHECK DAMAGE OF ABS WHEEL SPEED SENSOR OR TONE WHEEL.	Are there broken or damaged in the ABS wheel speed sensor piece or tone wheel?	Replace the ABS wheel speed sensor or tone wheel. Front: <Ref. to ABS-15, Front ABS Wheel Speed Sensor.> Rear: <Ref. to ABS-18, Rear ABS Wheel Speed Sensor.> and Front: <Ref. to ABS-21, Front Tone Wheel.> Rear: <Ref. to ABS-22, Rear Tone Wheel.>	Go to step 14.

Diagnostics Procedure with Diagnostic Trouble Code (DTC)

ABS (DIAGNOSTIC)

Step	Check	Yes	No
14 CHECK TONE WHEEL RUNOUT. Measure the tone wheel runout.	Is the runout less than 0.05 mm (0.0020 in)?	Go to step 15.	Replace the tone wheel. Front: <Ref. to ABS-21, Front Tone Wheel.> Rear: <Ref. to ABS-22, Rear Tone Wheel.>
15 CHECK RESISTANCE OF ABS WHEEL SPEED SENSOR. 1) Turn the ignition switch to OFF. 2) Disconnect the connector from ABS wheel speed sensor. 3) Measure the resistance between ABS wheel speed sensor connector terminals while shaking the harness lightly. <i>Terminal</i> <i>Front RH No. 1 — No. 2:</i> <i>Front LH No. 1 — No. 2:</i> <i>Rear RH No. 1 — No. 2:</i> <i>Rear LH No. 1 — No. 2:</i>	Is the resistance the following value? Front: 1 — 1.5 k Ω Rear: 1.025 — 1.265 k Ω	Go to step 16.	Replace the ABS wheel speed sensor. Front: <Ref. to ABS-15, Front ABS Wheel Speed Sensor.> Rear: <Ref. to ABS-18, Rear ABS Wheel Speed Sensor.>
16 CHECK GROUND SHORT OF ABS WHEEL SPEED SENSOR. Measure the resistance between ABS wheel speed sensor and chassis ground. <i>Terminal</i> <i>Front RH No. 1 — Chassis ground:</i> <i>Front LH No. 1 — Chassis ground:</i> <i>Rear RH No. 1 — Chassis ground:</i> <i>Rear LH No. 1 — Chassis ground:</i>	Is the resistance more than 1 M Ω ?	Go to step 17.	Replace the ABS wheel speed sensor. Front: <Ref. to ABS-15, Front ABS Wheel Speed Sensor.> Rear: <Ref. to ABS-18, Rear ABS Wheel Speed Sensor.>
17 CHECK HARNESS/CONNECTOR BETWEEN ABSCM&H/U AND ABS WHEEL SPEED SENSOR. 1) Connect the connector to ABS wheel speed sensor. 2) Disconnect the connector from ABSCM&H/U. 3) Measure the resistance at ABSCM&H/U connector terminals. <i>Connector & terminal</i> <i>DTC 22</i> <i>LHD: (B301) No. 11 — No. 12:</i> <i>RHD: (F49) No. 11 — No. 12:</i> <i>DTC 24</i> <i>LHD: (B301) No. 9 — No. 10:</i> <i>RHD: (F49) No. 9 — No. 10:</i> <i>DTC 26</i> <i>LHD: (B301) No. 14 — No. 15:</i> <i>RHD: (F49) No. 14 — No. 15:</i> <i>DTC 28</i> <i>LHD: (B301) No. 7 — No. 8:</i> <i>RHD: (F49) No. 7 — No. 8:</i>	Is the resistance the following value? Front: 1 — 1.5 k Ω Rear: 1.025 — 1.265 k Ω	Go to step 18.	Repair the harness connector between ABSCM&H/U and ABS wheel speed sensor.

Diagnostics Procedure with Diagnostic Trouble Code (DTC)

ABS (DIAGNOSTIC)

Step	Check	Yes	No
18 CHECK GROUND SHORT OF HARNESS. Measure the resistance between ABSCM&H/U connector and chassis ground. <i>Connector & terminal</i> DTC 22 <i>LHD: (B301) No. 11 — Chassis ground:</i> <i>RHD: (F49) No. 11 — Chassis ground:</i> DTC 24 <i>LHD: (B301) No. 9 — Chassis ground:</i> <i>RHD: (F49) No. 9 — Chassis ground:</i> DTC 26 <i>LHD: (B301) No. 14 — Chassis ground:</i> <i>RHD: (F49) No. 14 — Chassis ground:</i> DTC 28 <i>LHD: (B301) No. 7 — Chassis ground:</i> <i>RHD: (F49) No. 7 — Chassis ground:</i>	Is the resistance more than 1 M Ω ?	Go to step 19.	Repair the harness connector between ABSCM&H/U and ABS wheel speed sensor.
19 CHECK GROUND CIRCUIT OF ABSCM&H/U. Measure the resistance between ABSCM&H/U and chassis ground. <i>Connector & terminal</i> <i>LHD: (B301) No. 23 — Chassis ground:</i> <i>RHD: (F49) No. 23 — Chassis ground:</i>	Is the resistance less than 0.5 Ω ?	Go to step 20.	Repair the ABSCM&H/U ground harness.
20 CHECK POOR CONTACT IN CONNECTORS.	Is there poor contact in connectors between ABSCM&H/U and ABS wheel speed sensor?	Repair the connector.	Go to step 21.
21 CHECK SOURCES OF SIGNAL NOISE.	Is the car telephone or the wireless transmitter properly installed?	Go to step 22.	Properly install the car telephone or wireless transmitter.
22 CHECK SOURCES OF SIGNAL NOISE.	Are noise sources (such as an antenna) installed near the sensor harness?	Install the noise sources apart from sensor harness.	Go to step 23.
23 CHECK SHIELD CIRCUIT. 1) Connect all connectors. 2) Measure the resistance between shield connector and chassis ground. <i>Connector & terminal</i> DTC 22 <i>LHD: (F103) No. 1 — Chassis ground:</i> <i>RHD: (F48) No. 2 — Chassis ground:</i> DTC 24 <i>LHD: (F103) No. 8 — Chassis ground:</i> <i>RHD: (F48) No. 1 — Chassis ground:</i> DTC 26 <i>LHD: (F103) No. 2 — Chassis ground:</i> <i>RHD: (F48) No. 3 — Chassis ground:</i> DTC 28 <i>LHD: (F103) No. 2 — Chassis ground:</i> <i>RHD: (F48) No. 3 — Chassis ground:</i>	Is the resistance less than 0.5 Ω ?	Go to step 24.	Repair the shield harness.
24 CHECK ABSCM&H/U. 1) Connect all connectors. 2) Erase the memory. 3) Perform the inspection mode. 4) Read out the DTC.	Is the same DTC as in the current diagnosis still being output?	Replace the ABSCM only. <Ref. to ABS-8, ABSCM (ABS CONTROL MODULE), REPLACE, ABS Control Module and Hydraulic Control Unit (ABSCM&H/U).>	Go to step 25.

Diagnosics Procedure with Diagnostic Trouble Code (DTC)

ABS (DIAGNOSTIC)

Step	Check	Yes	No
25 CHECK ANY OTHER DIAGNOSTIC TROUBLE CODES (DTCs) APPEARANCE.	Are other DTCs being output?	Proceed with the diagnosis corresponding to DTC.	A temporary noise interference. NOTE: Although the ABS warning light remains illuminating at this point, this is a normal condition. Vehicle must be driven at approx. 12 km/h (7.46 MPH) or faster to turn off ABS warning light. Make sure that the ABS warning light goes off after driving vehicle.

Diagnostics Procedure with Diagnostic Trouble Code (DTC)

ABS (DIAGNOSTIC)

K: DTC 29 ABNORMAL ABS SENSOR SIGNAL ON ANY ONE OF FOUR SENSORS

DIAGNOSIS:

- Faulty ABS wheel speed sensor signal (noise, irregular signal, etc.)
- Faulty tone wheel
- Wheels turning freely for a long time

TROUBLE SYMPTOM:

- ABS does not operate.
- EBD does not operate.

NOTE:

In addition to the ABS warning light, brake warning light illuminates.

Diagnostics Procedure with Diagnostic Trouble Code (DTC)

ABS (DIAGNOSTIC)

WIRING DIAGRAM:

- LHD model

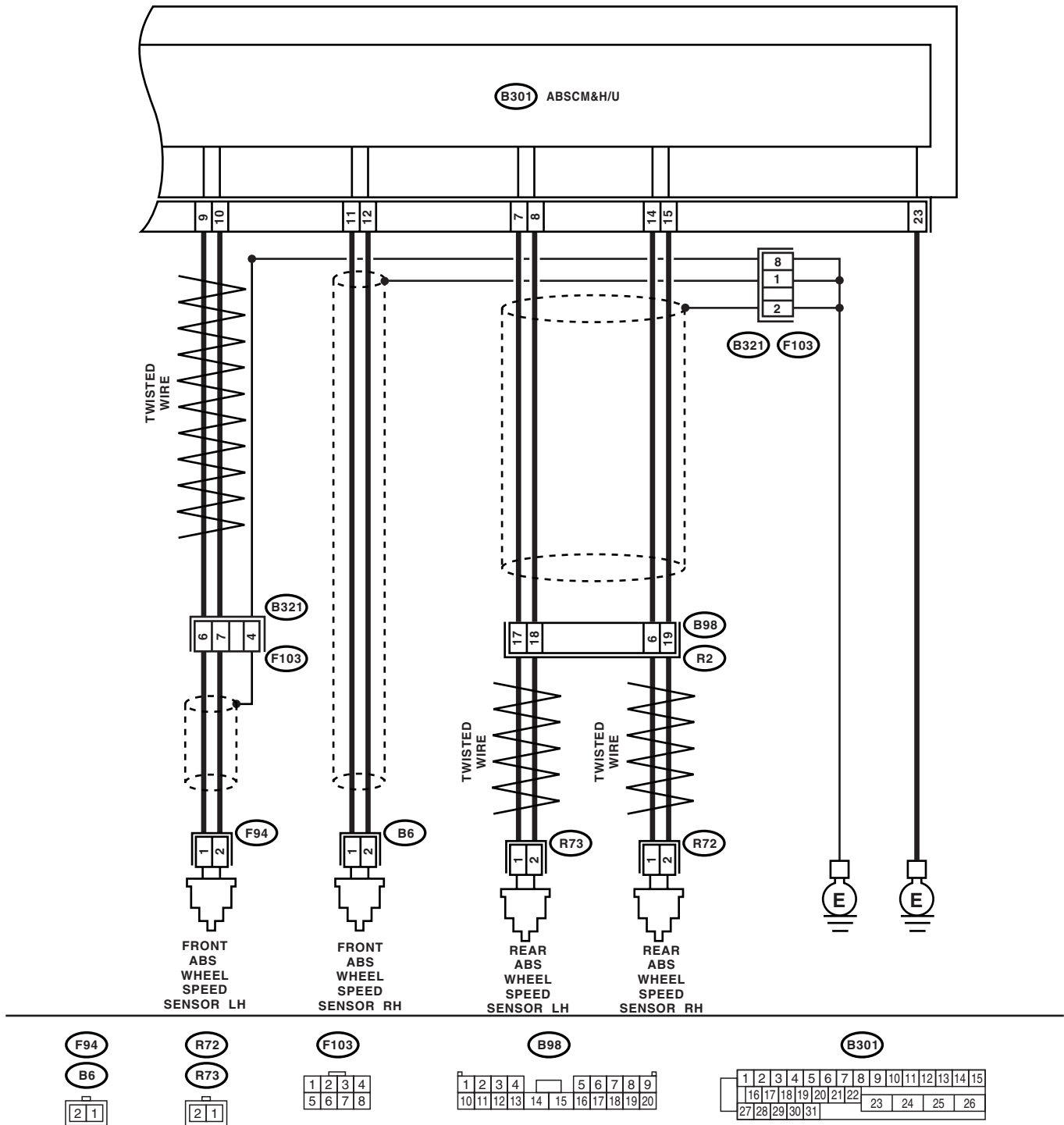

ABS00454

Diagnostics Procedure with Diagnostic Trouble Code (DTC)

ABS (DIAGNOSTIC)

- RHD model

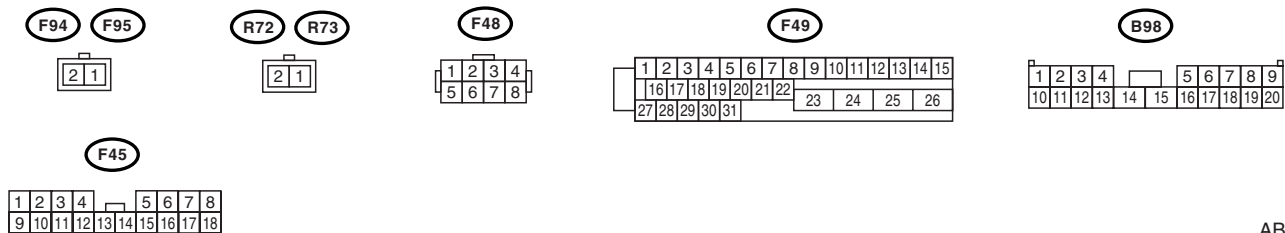
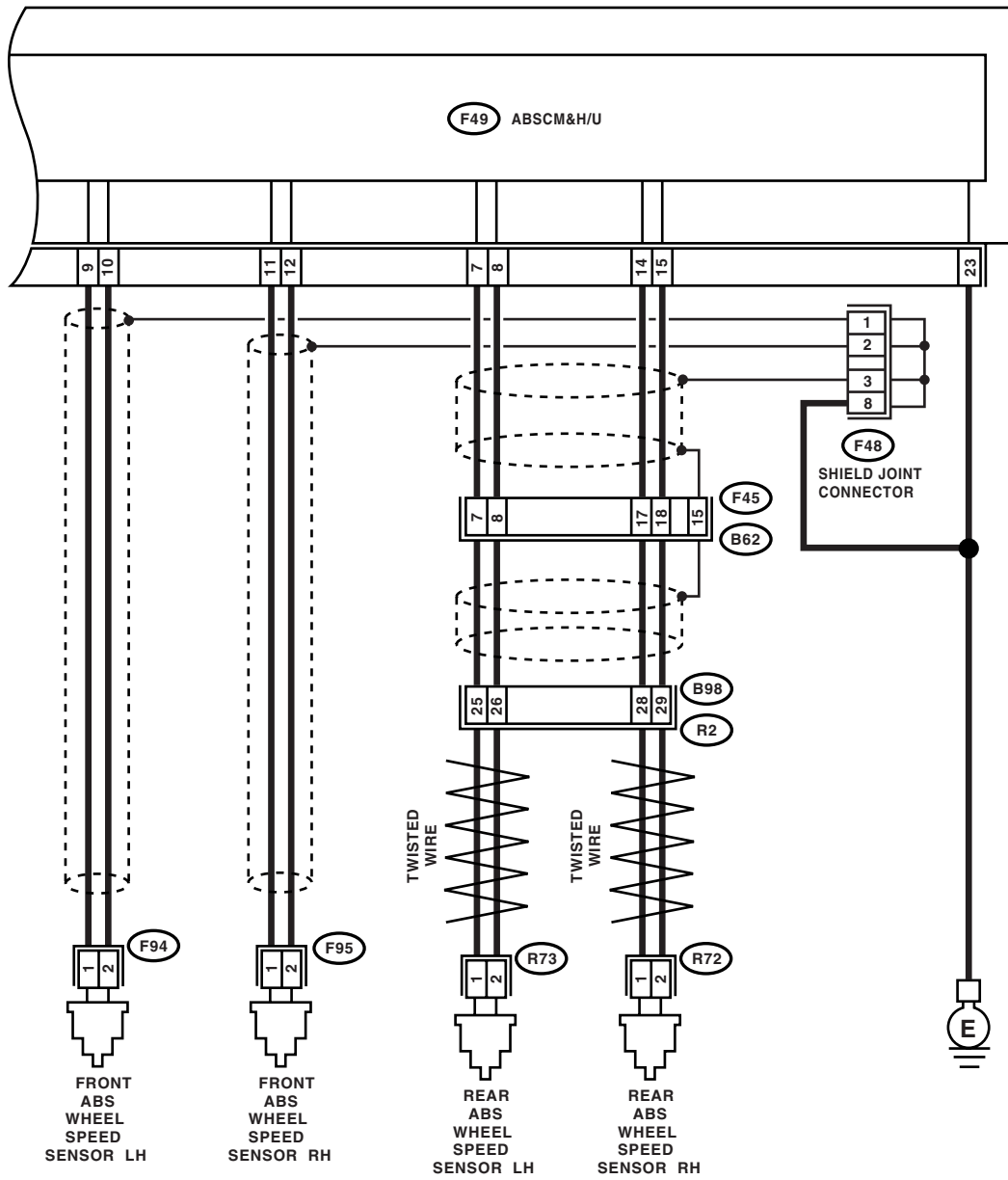

ABS00467

Diagnostics Procedure with Diagnostic Trouble Code (DTC)

ABS (DIAGNOSTIC)

Step	Check	Yes	No	
1	CHECK IF THE WHEELS HAVE TURNED FREELY FOR A LONG TIME.	Check if the wheels have been turned freely for more than one minute, such as when vehicle is jacked-up, under full-lock cornering or when tire is not in contact with road surface. Did the wheels turn freely?	The ABS is normal. Erase the DTC. NOTE: When the wheels turn freely for a long time, such as when vehicle is towed or jacked-up, or when steering wheel is continuously turned all way, this trouble code may sometimes occur.	Go to step 2.
2	CHECK TIRE SPECIFICATIONS. Turn the ignition switch to OFF.	Are the tire specifications correct?	Go to step 3.	Replace the tire.
3	CHECK WEAR OF TIRE.	Is the tire worn excessively?	Replace the tire.	Go to step 4.
4	CHECK TIRE PRESSURE.	Is the tire pressure correct?	Go to step 5.	Adjust the tire pressure.
5	CHECK INSTALLATION OF ABS WHEEL SPEED SENSOR.	Are the ABS wheel speed sensor installation bolts tightend 33 N·m (3.4 kgf-m, 24.6 ft-lb)	Go to step 6.	Tighten the ABS wheel speed sensor installation bolts securely.
6	CHECK ABS WHEEL SPEED SENSOR GAP. Measure the tone wheel to ABS wheel speed sensor piece gap over entire perimeter of the wheel.	Is the gap the following value? Front wheel: 0.3 — 0.8 mm (0.012 — 0.031 in) Rear wheel: 0.7 — 1.2 mm (0.028 — 0.047 in)	Go to step 7.	Adjust the gap. NOTE: Adjust the gap using spacer (Part No. 26755AA000). If the spacers cannot correct gap, replace worn ABS wheel speed sensor or worn tone wheel.
7	PREPARE OSCILLOSCOPE.	Is an oscilloscope available?	Go to step 8.	Go to step 9.

Diagnostics Procedure with Diagnostic Trouble Code (DTC)

ABS (DIAGNOSTIC)

Step	Check	Yes	No
<p>8 CHECK ABS WHEEL SPEED SENSOR SIGNAL. 1) Raise all four wheels off ground. 2) Turn the ignition switch to OFF. 3) Connect the oscilloscope to connector (B6), (B98), (F95) or (F94) in accordance with DTC. 4) Turn the ignition switch to ON. 5) Rotate the wheels and measure voltage at specified frequency. <Ref. to ABS-17, WAVEFORM, Control Module I/O Signal.></p> <p>NOTE: When this inspection is completed, ABSCM&H/U sometimes stores the DTC 29.</p> <p>Connector & terminal Front RH <i>LHD: (B6) No. 1 (+) — No. 2 (-):</i> <i>RHD: (F95) No. 1 (+) — No. 2 (-):</i> Front LH <i>LHD: (F103) No. 6 (+) — No. 7 (-):</i> <i>RHD: (F94) No. 1 (+) — No. 2 (-):</i> Rear RH <i>LHD: (B98) No. 6 (+) — No. 19 (-):</i> <i>RHD: (B98) No. 28 (+) — No. 29 (-):</i> Rear LH <i>LHD: (B98) No. 17 (+) — No. 18 (-):</i> <i>RHD: (B98) No. 25 (+) — No. 26 (-):</i></p>	<p>Is an oscilloscope pattern the same as shown in the figure? <Ref. to ABS-17, WAVEFORM, Control Module I/O Signal.></p>	<p>Go to step 12.</p>	<p>Go to step 9.</p>
<p>9 CHECK CONTAMINATION OF ABS WHEEL SPEED SENSOR OR TONE WHEEL. Remove the disc rotor or drum from hub.</p>	<p>Is the ABS wheel speed sensor piece or tone wheel contaminated by dirt or other foreign matter?</p>	<p>Thoroughly remove dirt or other foreign matter.</p>	<p>Go to step 10.</p>
<p>10 CHECK DAMAGE OF ABS WHEEL SPEED SENSOR OR TONE WHEEL.</p>	<p>Are there broken or damaged teeth in the ABS wheel speed sensor piece or tone wheel?</p>	<p>Replace the ABS wheel speed sensor or tone wheel. Front: <Ref. to ABS-15, Front ABS Wheel Speed Sensor.> Rear: <Ref. to ABS-18, Rear ABS Wheel Speed Sensor.> and Front: <Ref. to ABS-21, Front Tone Wheel.> Rear: <Ref. to ABS-22, Rear Tone Wheel.></p>	<p>Go to step 11.</p>
<p>11 CHECK TONE WHEEL RUNOUT. Measure the tone wheel runout.</p>	<p>Is the runout less than 0.05 mm (0.0020 in)?</p>	<p>Go to step 12.</p>	<p>Replace the tone wheel. Front: <Ref. to ABS-21, Front Tone Wheel.> Rear: <Ref. to ABS-22, Rear Tone Wheel.></p>

Diagnosics Procedure with Diagnostic Trouble Code (DTC)

ABS (DIAGNOSTIC)

Step	Check	Yes	No
12 CHECK ABSCM&H/U. 1) Turn the ignition switch to OFF. 2) Connect all connectors. 3) Erase the memory. 4) Perform the inspection mode. 5) Read out the DTC.	Is the same DTC as in the current diagnosis still being output?	Replace the ABSCM only. <Ref. to ABS-8, ABSCM (ABS CONTROL MODULE), REPLACE, ABS Control Module and Hydraulic Control Unit (ABSCM&H/U).>	Go to step 13 .
13 CHECK ANY OTHER DIAGNOSTIC TROUBLE CODES (DTCs) APPEARANCE.	Are other DTCs being output?	Proceed with the diagnosis corresponding to DTC.	A temporary poor contact.

Diagnosics Procedure with Diagnostic Trouble Code (DTC)

ABS (DIAGNOSTIC)

L: DTC 31 FRONT RIGHT INLET VALVE MALFUNCTION

NOTE:

For the diagnostic procedure, refer to DTC 37. <Ref. to ABS-125, DTC 37 REAR LEFT INLET VALVE MALFUNCTION, Diagnosics Procedure with Diagnostic Trouble Code (DTC).>

M: DTC 33 FRONT LEFT INLET VALVE MALFUNCTION

NOTE:

For the diagnostic procedure, refer to DTC 37. <Ref. to ABS-125, DTC 37 REAR LEFT INLET VALVE MALFUNCTION, Diagnosics Procedure with Diagnostic Trouble Code (DTC).>

N: DTC 35 REAR RIGHT INLET VALVE MALFUNCTION

NOTE:

For the diagnostic procedure, refer to DTC 37. <Ref. to ABS-125, DTC 37 REAR LEFT INLET VALVE MALFUNCTION, Diagnosics Procedure with Diagnostic Trouble Code (DTC).>

O: DTC 37 REAR LEFT INLET VALVE MALFUNCTION

DIAGNOSIS:

- Faulty harness connector
- Faulty inlet solenoid valve

TROUBLE SYMPTOM:

- ABS does not operate.
- EBD does not operate.

NOTE:

In addition to the ABS warning light, brake warning light illuminates.

Diagnostics Procedure with Diagnostic Trouble Code (DTC)

ABS (DIAGNOSTIC)

WIRING DIAGRAM:

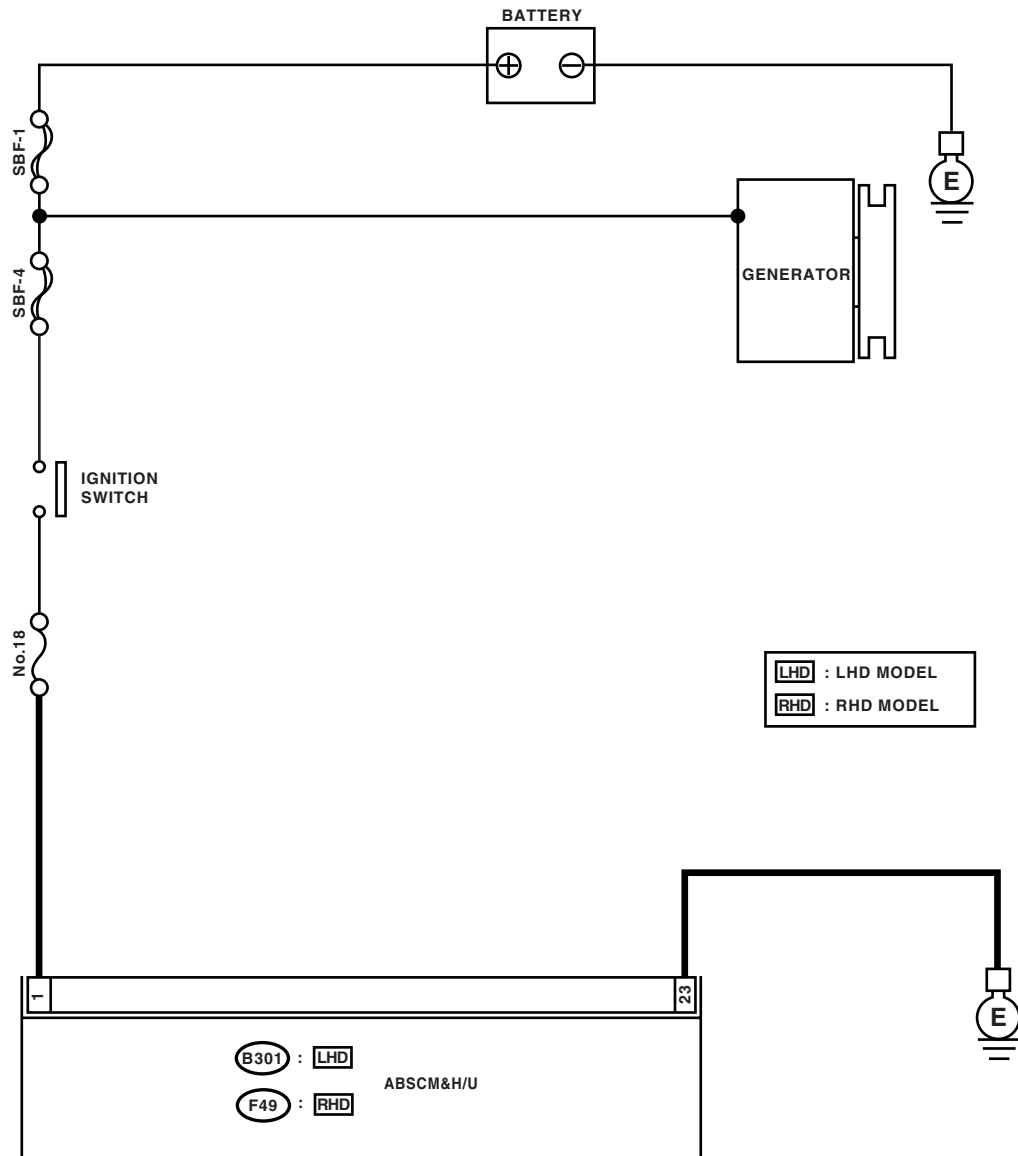

(B301) : LHD

(F49) : RHD

1	2	3	4	5	6	7	8	9	10	11	12	13	14	15
16	17	18	19	20	21	22	23	24	25	26				
27	28	29	30	31										

ABS00229

Diagnostics Procedure with Diagnostic Trouble Code (DTC)

ABS (DIAGNOSTIC)

Step	Check	Yes	No
1 CHECK INPUT VOLTAGE OF ABSCM&H/U. 1) Turn the ignition switch to OFF. 2) Disconnect the connector from ABSCM&H/U. 3) Run the engine at idle. 4) Measure the voltage between ABSCM&H/U connector and chassis ground. Connector & terminal LHD: (B301) No. 1 (+) — Chassis ground (-): RHD: (F49) No. 1 (+) — Chassis ground (-):	Is the voltage 10 — 15 V?	Go to step 2.	Repair the harness connector between battery, ignition switch and ABSCM&H/U.
2 CHECK GROUND CIRCUIT OF ABSCM&H/U. 1) Turn the ignition switch to OFF. 2) Measure the resistance between ABSCM&H/U connector and chassis ground. Connector & terminal LHD: (B301) No. 23 — Chassis ground: RHD: (F49) No. 23 — Chassis ground:	Is the resistance less than 0.5 Ω ?	Go to step 3.	Repair the ABSCM&H/U ground harness.
3 CHECK POOR CONTACT IN CONNECTORS.	Is there poor contact in connectors between generator, battery and ABSCM&H/U?	Repair the connector.	Go to step 4.
4 CHECK ABSCM&H/U. 1) Connect all connectors. 2) Erase the memory. 3) Perform the inspection mode. 4) Read out the DTC.	Is the same DTC as in the current diagnosis still being output?	Replace the ABSCM&H/U. <Ref. to ABS-7, ABS Control Module and Hydraulic Control Unit (ABSCM&H/U).>	Go to step 5.
5 CHECK ANY OTHER DIAGNOSTIC TROUBLE CODES (DTCs) APPEARANCE.	Are other DTCs being output?	Proceed with the diagnosis corresponding to DTC.	A temporary poor contact.

Diagnostics Procedure with Diagnostic Trouble Code (DTC)

ABS (DIAGNOSTIC)

P: DTC 32 FRONT RIGHT OUTLET VALVE MALFUNCTION

NOTE:

For the diagnostic procedure, refer to DTC 38. <Ref. to ABS-129, DTC 38 REAR LEFT OUTLET VALVE MALFUNCTION, Diagnostics Procedure with Diagnostic Trouble Code (DTC).>

Q: DTC 34 FRONT LEFT OUTLET VALVE MALFUNCTION

NOTE:

For the diagnostic procedure, refer to DTC 38. <Ref. to ABS-129, DTC 38 REAR LEFT OUTLET VALVE MALFUNCTION, Diagnostics Procedure with Diagnostic Trouble Code (DTC).>

R: DTC 36 REAR RIGHT OUTLET VALVE MALFUNCTION

NOTE:

For the diagnostic procedure, refer to DTC 38. <Ref. to ABS-129, DTC 38 REAR LEFT OUTLET VALVE MALFUNCTION, Diagnostics Procedure with Diagnostic Trouble Code (DTC).>

S: DTC 38 REAR LEFT OUTLET VALVE MALFUNCTION

DIAGNOSIS:

- Faulty harness connector
- Faulty outlet solenoid valve

TROUBLE SYMPTOM:

- ABS does not operate.
- EBD does not operate.

NOTE:

In addition to the ABS warning light, brake warning light illuminates.

Diagnostics Procedure with Diagnostic Trouble Code (DTC)

ABS (DIAGNOSTIC)

WIRING DIAGRAM:

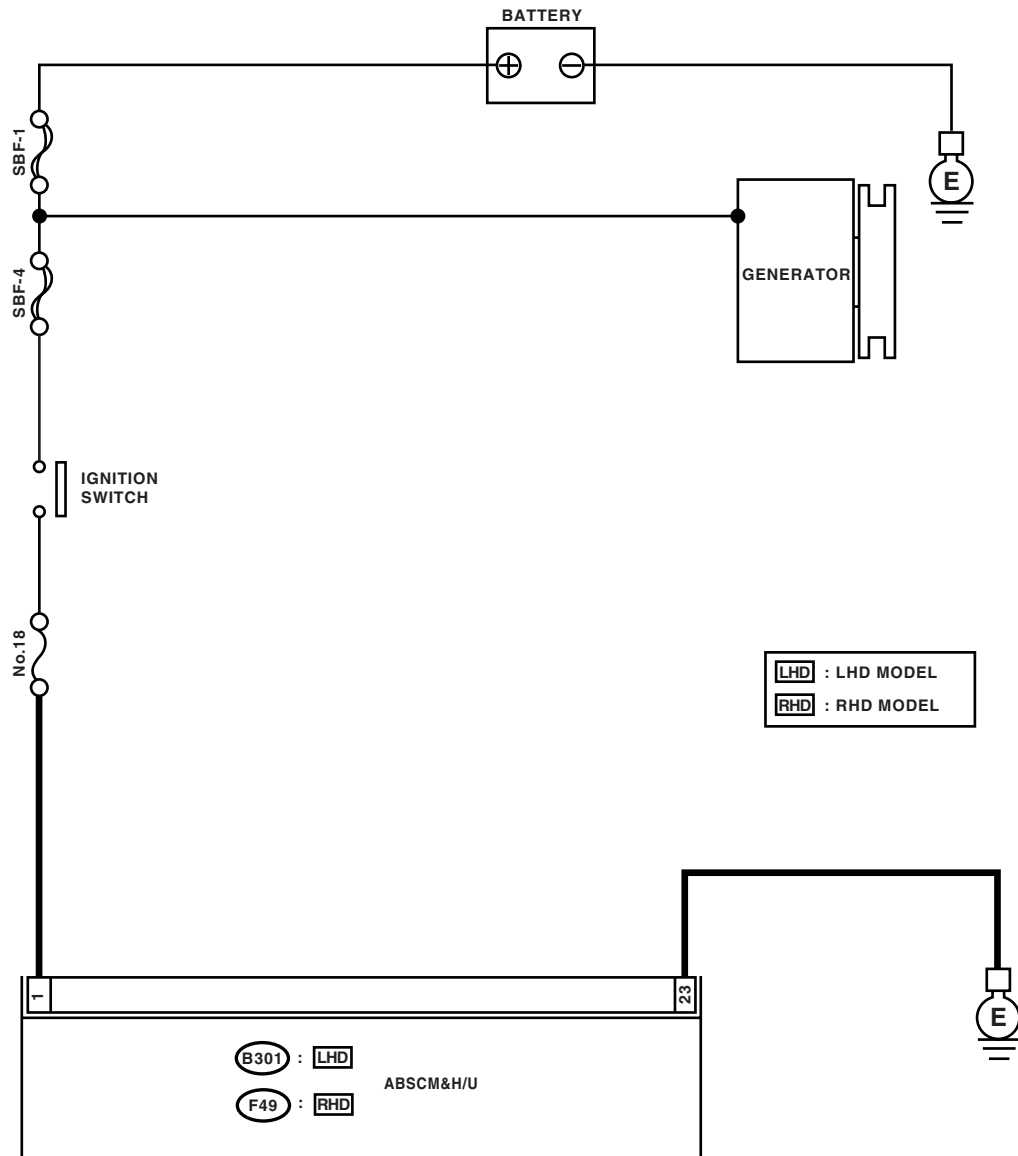

(B301) : LHD

(F49) : RHD

1	2	3	4	5	6	7	8	9	10	11	12	13	14	15
16	17	18	19	20	21	22	23	24	25	26				
27	28	29	30	31										

ABS00229

Diagnostics Procedure with Diagnostic Trouble Code (DTC)

ABS (DIAGNOSTIC)

Step	Check	Yes	No
1 CHECK INPUT VOLTAGE OF ABSCM&H/U. 1) Turn the ignition switch to OFF. 2) Disconnect the connector from ABSCM&H/U. 3) Run the engine at idle. 4) Measure the voltage between ABSCM&H/U connector and chassis ground. Connector & terminal LHD: (B301) No. 1 (+) — Chassis ground (-): RHD: (F49) No. 1 (+) — Chassis ground (-):	Is the voltage 10 — 15 V?	Go to step 2.	Repair the harness connector between battery, ignition switch and ABSCM&H/U.
2 CHECK GROUND CIRCUIT OF ABSCM&H/U. 1) Turn the ignition switch to OFF. 2) Measure the resistance between ABSCM&H/U connector and chassis ground. Connector & terminal LHD: (B301) No. 23 — Chassis ground: RHD: (F49) No. 23 — Chassis ground:	Is the resistance less than 0.5 Ω ?	Go to step 3.	Repair the ABSCM&H/U ground harness.
3 CHECK POOR CONTACT IN CONNECTORS.	Is there poor contact in connectors between generator, battery and ABSCM&H/U?	Repair the connector.	Go to step 4.
4 CHECK ABSCM&H/U. 1) Connect all connectors. 2) Erase the memory. 3) Perform the inspection mode. 4) Read out the DTC.	Is the same DTC as in the current diagnosis still being output?	Replace the ABSCM&H/U. <Ref. to ABS-7, ABS Control Module and Hydraulic Control Unit (ABSCM&H/U).>	Go to step 5.
5 CHECK ANY OTHER DIAGNOSTIC TROUBLE CODES (DTCs) APPEARANCE.	Are other DTCs being output?	Proceed with the diagnosis corresponding to DTC.	A temporary poor contact.

Diagnosics Procedure with Diagnostic Trouble Code (DTC)

ABS (DIAGNOSTIC)

T: DTC 41 ABS CONTROL MODULE MALFUNCTION

DIAGNOSIS:

Faulty ABSCM&H/U

TROUBLE SYMPTOM:

- ABS does not operate.
- EBD does not operate.

NOTE:

In addition to the ABS warning light, brake warning light illuminates.

WIRING DIAGRAM:

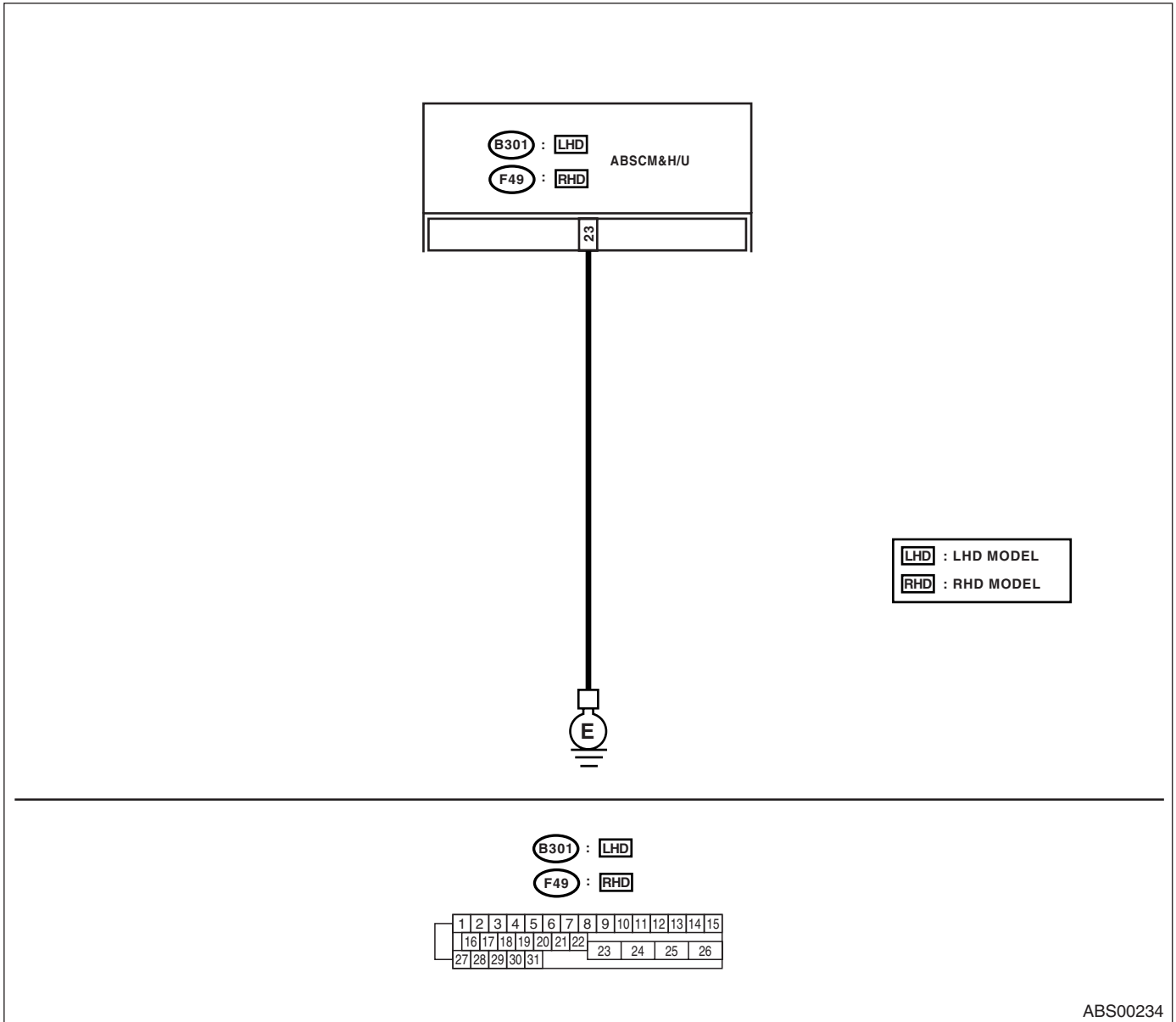

ABS00234

Diagnostics Procedure with Diagnostic Trouble Code (DTC)

ABS (DIAGNOSTIC)

Step	Check	Yes	No
1 CHECK GROUND CIRCUIT OF ABSCM&H/U. 1) Turn the ignition switch to OFF. 2) Disconnect the connector from ABSCM&H/U. 3) Measure the resistance between ABSCM&H/U and chassis ground. <i>Connector & terminal</i> <i>LHD: (B301) No. 23 — Chassis ground:</i> <i>RHD: (F49) No. 23 — Chassis ground:</i>	Is the resistance less than 0.5 Ω ?	Go to step 2.	Repair the ABSCM&H/U ground harness.
2 CHECK POOR CONTACT IN CONNECTORS.	Is there poor contact in connectors among battery, ignition switch and ABSCM&H/U?	Repair the connector.	Go to step 3.
3 CHECK SOURCES OF SIGNAL NOISE.	Is the car telephone or wireless transmitter properly installed?	Go to step 4.	Properly install the car telephone or wireless transmitter.
4 CHECK SOURCES OF SIGNAL NOISE.	Are noise sources (such as an antenna) installed near the sensor harness?	Install the noise sources apart from sensor harness.	Go to step 5.
5 CHECK ABSCM&H/U. 1) Turn the ignition switch to OFF. 2) Connect all connectors. 3) Erase the memory. 4) Perform the inspection mode. 5) Read out the DTC.	Is the same DTC as in current diagnosis still being output?	Replace the ABSCM only. <Ref. to ABS-8, ABSCM (ABS CONTROL MODULE), REPLACE, ABS Control Module and Hydraulic Control Unit (ABSCM&H/U).>	Go to step 6.
6 CHECK ANY OTHER DIAGNOSTIC TROUBLE CODES (DTCs) APPEARANCE.	Are other DTCs being output?	Proceed with the diagnosis corresponding to DTC.	A temporary poor contact.

Diagnosics Procedure with Diagnostic Trouble Code (DTC)

ABS (DIAGNOSTIC)

U: DTC 42 POWER SUPPLY VOLTAGE TOO LOW

DIAGNOSIS:

Power source voltage of the ABSCM&H/U is low.

TROUBLE SYMPTOM:

- ABS does not operate.
- EBD does not operate.

NOTE:

In addition to the ABS warning light, brake warning light illuminates temporarily. Both warning lights go off on the recovery of voltage.

Diagnostics Procedure with Diagnostic Trouble Code (DTC)

ABS (DIAGNOSTIC)

WIRING DIAGRAM:

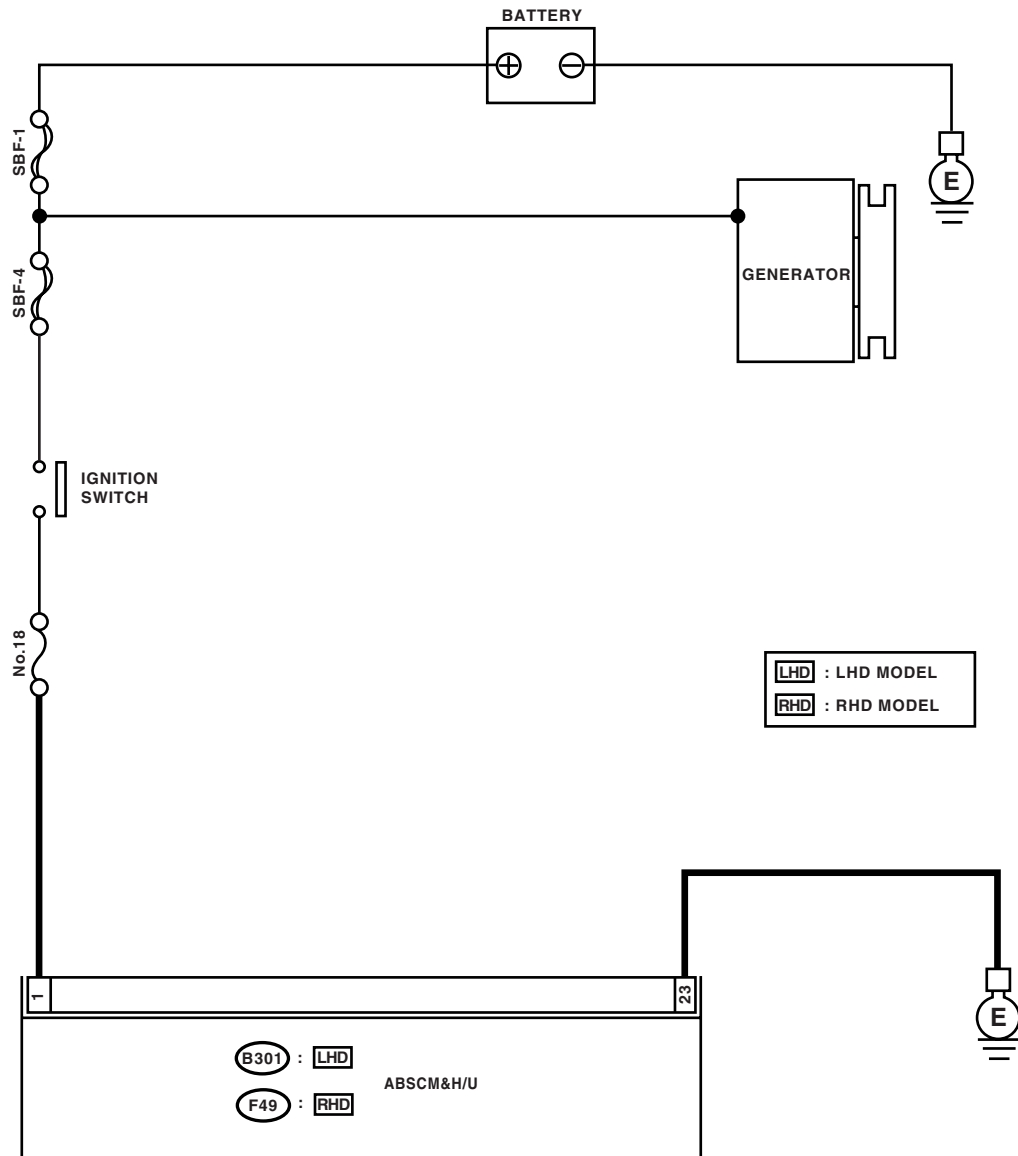

(B301) : LHD

(F49) : RHD

1	2	3	4	5	6	7	8	9	10	11	12	13	14	15
16	17	18	19	20	21	22	23	24	25	26				
27	28	29	30	31										

ABS00229

Diagnostics Procedure with Diagnostic Trouble Code (DTC)

ABS (DIAGNOSTIC)

Step	Check	Yes	No
1 CHECK GENERATOR. 1) Start the engine. 2) Idle after warm-up. 3) Measure the voltage between generator B terminal and chassis ground. <i>Terminal</i> <i>Generator B terminal (+) — Chassis ground (-):</i>	Is the voltage 10 — 15 V?	Go to step 2.	Repair the generator. <Ref. to SC(H4SO)-15, Generator.>
2 CHECK BATTERY TERMINAL. Turn the ignition switch to OFF.	Are the positive and negative battery terminals tightly clamped?	Go to step 3.	Tighten the clamp of terminal.
3 CHECK INPUT VOLTAGE OF ABSCM&H/U. 1) Disconnect the connector from ABSCM&H/U. 2) Run the engine at idle. 3) Operate the electric load applying devices, such as the headlight, A/C, and defogger. 4) Measure the voltage between ABSCM&H/U connector and chassis ground. <i>Connector & terminal</i> <i>LHD: (B301) No. 1 (+) — Chassis ground (-):</i> <i>RHD: (F49) No. 1 (+) — Chassis ground (-):</i>	Is the voltage 10 — 15 V?	Go to step 4.	Repair the harness connector between battery, ignition switch and ABSCM&H/U.
4 CHECK GROUND CIRCUIT OF ABSCM&H/U. 1) Turn the ignition switch to OFF. 2) Measure the resistance between ABSCM&H/U connector and chassis ground. <i>Connector & terminal</i> <i>LHD: (B301) No. 23 — Chassis ground:</i> <i>RHD: (F49) No. 23 — Chassis ground:</i>	Is the resistance less than 0.5 Ω ?	Go to step 5.	Repair the ABSCM&H/U ground harness.
5 CHECK POOR CONTACT IN CONNECTORS.	Is there poor contact in connectors between generator, battery and ABSCM&H/U?	Repair the connector.	Go to step 6.
6 CHECK ABSCM&H/U. 1) Connect all connectors. 2) Erase the memory. 3) Perform the inspection mode. 4) Read out the DTC.	Is the same DTC as in the current diagnosis still being output?	Replace the ABSCM only. <Ref. to ABS-8, ABSCM (ABS CONTROL MODULE), REPLACE, ABS Control Module and Hydraulic Control Unit (ABSCM&H/U).>	Go to step 7.
7 CHECK ANY OTHER DIAGNOSTIC TROUBLE CODES (DTCs) APPEARANCE.	Are other DTCs being output?	Proceed with the diagnosis corresponding to DTC.	A temporary poor contact.

V: DTC 42 POWER SUPPLY VOLTAGE TOO HIGH

DIAGNOSIS:

Power source voltage of the ABSCM&H/U is high.

TROUBLE SYMPTOM:

- ABS does not operate.
- EBD does not operate.

NOTE:

In addition to the ABS warning light, brake warning light illuminates temporarily. Both warning lights go off on the recovery of voltage.

Diagnostics Procedure with Diagnostic Trouble Code (DTC)

ABS (DIAGNOSTIC)

WIRING DIAGRAM:

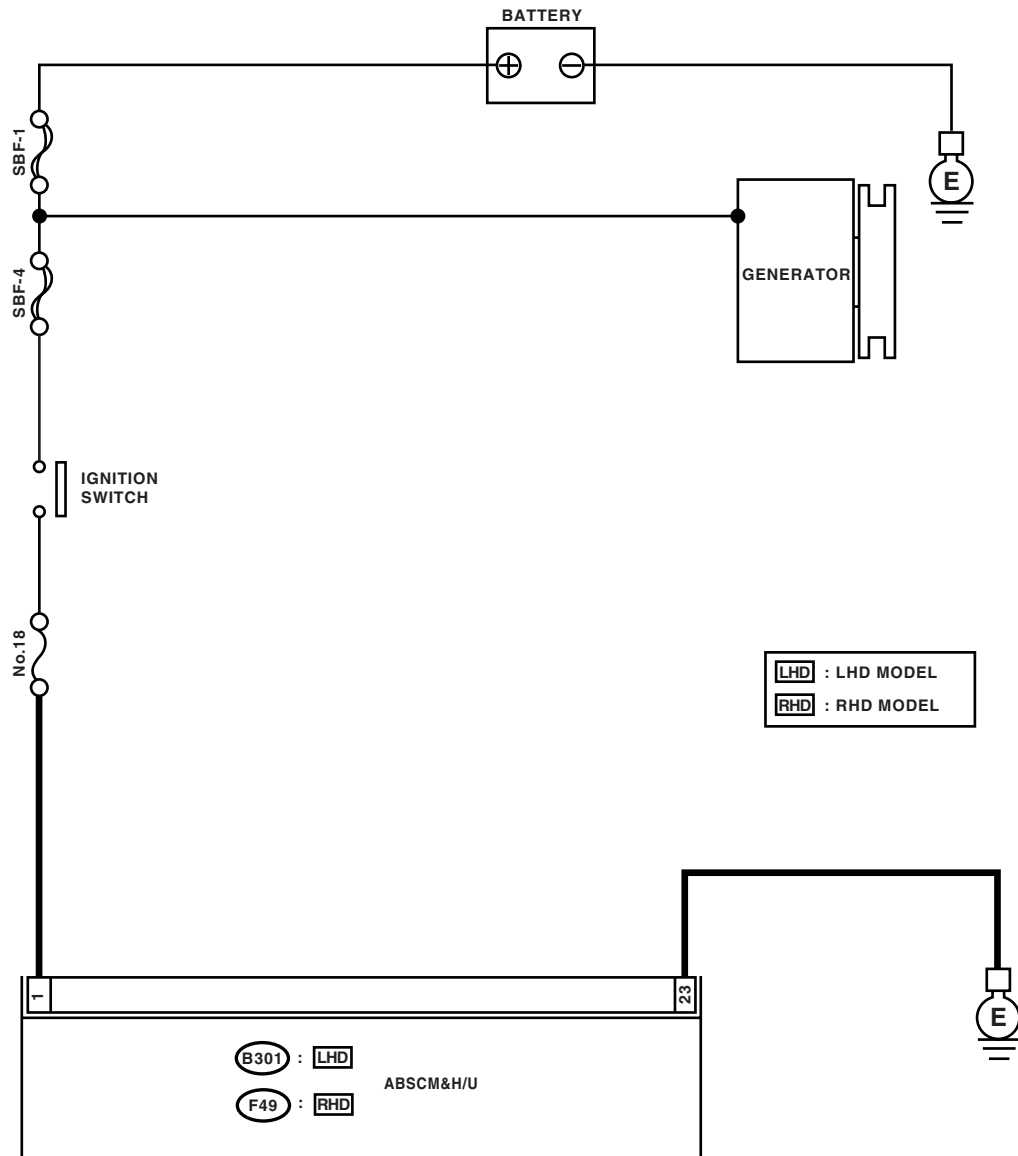

(B301) : LHD

(F49) : RHD

1	2	3	4	5	6	7	8	9	10	11	12	13	14	15
16	17	18	19	20	21	22	23	24	25	26				
27	28	29	30	31										

ABS00229

Diagnostics Procedure with Diagnostic Trouble Code (DTC)

ABS (DIAGNOSTIC)

Step	Check	Yes	No
1 CHECK GENERATOR. 1) Start the engine. 2) Idle after warm-up. 3) Measure the voltage between generator B terminal and chassis ground. <i>Terminal</i> <i>Generator B terminal (+) — Chassis ground (-):</i>	Is the voltage 10 — 17 V?	Go to step 2.	Repair the generator. <Ref. to SC(H4SO)-15, Generator.>
2 CHECK BATTERY TERMINAL. Turn the ignition switch to OFF.	Are the positive and negative battery terminals tightly clamped?	Go to step 3.	Tighten the clamp of terminal.
3 CHECK INPUT VOLTAGE OF ABSCM&H/U. 1) Disconnect the connector from ABSCM&H/U. 2) Run the engine at idle. 3) Operate the electric load applying devices, such as the headlight, A/C, and defogger. 4) Measure the voltage between ABSCM&H/U connector and chassis ground. <i>Connector & terminal</i> <i>LHD: (B301) No. 1 (+) — Chassis ground (-):</i> <i>RHD: (F49) No. 1 (+) — Chassis ground (-):</i>	Is the voltage 10 — 17 V?	Go to step 4.	Repair the harness connector between battery, ignition switch and ABSCM&H/U.
4 CHECK GROUND CIRCUIT OF ABSCM&H/U. 1) Turn the ignition switch to OFF. 2) Measure the resistance between ABSCM&H/U connector and chassis ground. <i>Connector & terminal</i> <i>LHD: (B301) No. 23 — Chassis ground:</i> <i>RHD: (F49) No. 23 — Chassis ground:</i>	Is the resistance less than 0.5 Ω ?	Go to step 5.	Repair the ABSCM&H/U ground harness.
5 CHECK POOR CONTACT IN CONNECTORS.	Is there poor contact in connectors between generator, battery and ABSCM&H/U?	Repair the connector.	Go to step 6.
6 CHECK ABSCM&H/U. 1) Connect all connectors. 2) Erase the memory. 3) Perform the inspection mode. 4) Read out the DTC.	Is the same DTC as in the current diagnosis still being output?	Replace the ABSCM only. <Ref. to ABS-8, ABSCM (ABS CONTROL MODULE), REPLACE, ABS Control Module and Hydraulic Control Unit (ABSCM&H/U).>	Go to step 7.
7 CHECK ANY OTHER DIAGNOSTIC TROUBLE CODES (DTCs) APPEARANCE.	Are other DTCs being output?	Proceed with the diagnosis corresponding to DTC.	A temporary poor contact.

Diagnostics Procedure with Diagnostic Trouble Code (DTC)

ABS (DIAGNOSTIC)

W: DTC 44 ABS-AT CONTROL (NON CONTROLLED)

DIAGNOSIS:

Combination of AT control faults

TROUBLE SYMPTOM:

ABS does not operate.

WIRING DIAGRAM:

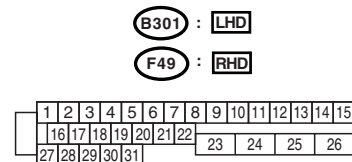
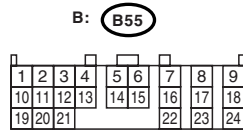
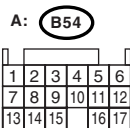
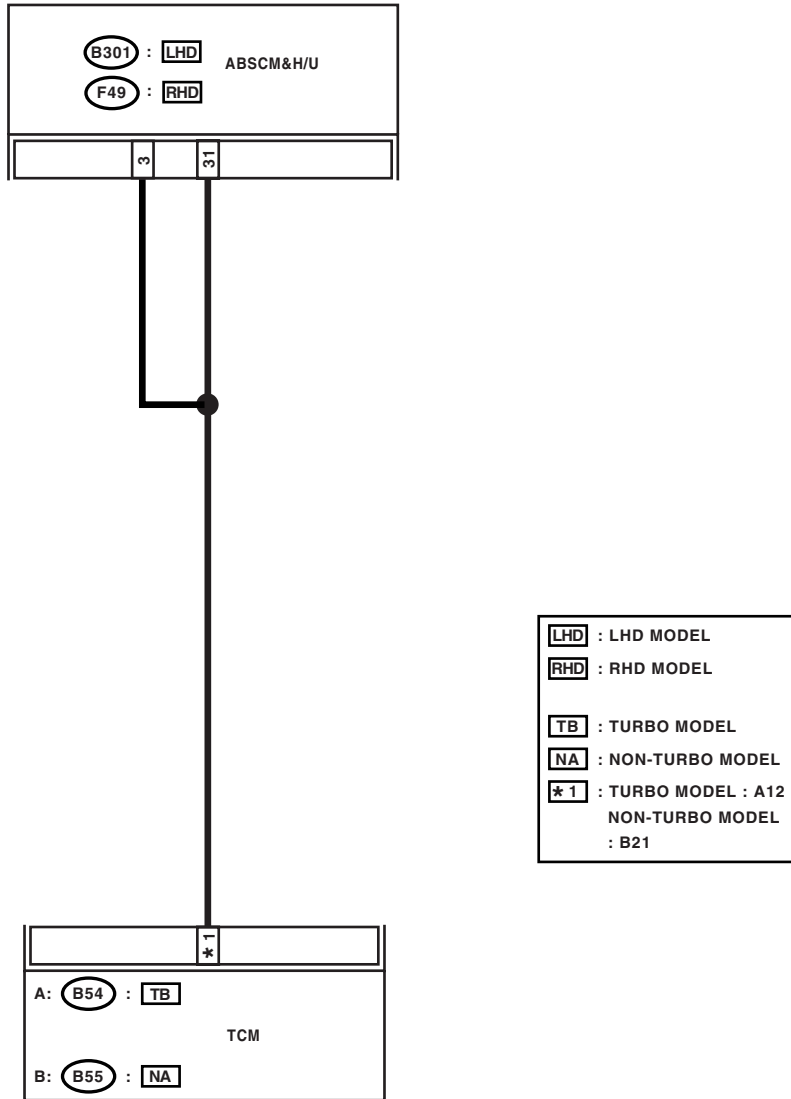

ABS00455

Diagnostics Procedure with Diagnostic Trouble Code (DTC)

ABS (DIAGNOSTIC)

Step	Check	Yes	No
1 CHECK SPECIFICATIONS OF THE ABSCM&H/U. Check specifications of the mark on the ABSCM&H/U. <i>CO: AT</i> <i>CP: MT</i>	Does the vehicle specification and ABSCM&H/U specification match?	Go to step 2.	Replace the ABSCM&H/U. <Ref. to ABS-7, ABS Control Module and Hydraulic Control Unit (ABSCM&H/U).>
2 CHECK GROUND SHORT OF HARNESS. 1) Turn the ignition switch to OFF. 2) Disconnect the two connectors from TCM. 3) Disconnect the connector from ABSCM&H/U. 4) Measure the resistance between ABSCM&H/U connector and chassis ground. <i>Connector & terminal</i> <i>LHD: (B301) No. 3 — Chassis ground:</i> <i>RHD: (F49) No. 3 — Chassis ground:</i>	Is the resistance more than 1 MΩ?	Go to step 3.	Repair the harness between TCM and ABSCM&H/U.
3 CHECK TCM. 1) Connect all connectors to TCM. 2) Turn the ignition switch to ON. 3) Measure the voltage between TCM connector terminal and chassis ground. <i>Connector & terminal</i> <i>Turbo Model:</i> <i>(B54) No. 12 (+) — Chassis ground (-):</i> <i>Non-turbo Model:</i> <i>(B55) No. 21 (+) — Chassis ground (-):</i>	Is the voltage 10 — 15 V?	Go to step 5.	Go to step 4.
4 CHECK AT.	Is the AT functioning normally?	Replace the TCM.	Repair the AT.
5 CHECK OPEN CIRCUIT OF HARNESS. Measure the voltage between ABSCM&H/U connector and chassis ground. <i>Connector & terminal</i> <i>LHD:</i> <i>(B301) No. 3 (+) — Chassis ground (-):</i> <i>(B301) No. 31 (+) — Chassis ground (-):</i> <i>RHD:</i> <i>(F49) No. 3 (+) — Chassis ground (-):</i> <i>(F49) No. 31 (+) — Chassis ground (-):</i>	Is the voltage more than 10 V?	Go to step 6.	Repair the harness/connector between TCM and ABSCM&H/U.
6 CHECK POOR CONTACT IN CONNECTORS.	Is there poor contact in connectors between TCM and ABSCM&H/U?	Repair the connector.	Go to step 7.
7 CHECK ABSCM&H/U. 1) Connect all connectors. 2) Erase the memory. 3) Perform the inspection mode. 4) Read out the DTC.	Is the same DTC as in the current diagnosis still being output?	Replace the ABSCM only. <Ref. to ABS-8, ABSCM (ABS CONTROL MODULE), REPLACE, ABS Control Module and Hydraulic Control Unit (ABSCM&H/U).>	Go to step 8.
8 CHECK ANY OTHER DIAGNOSTIC TROUBLE CODES (DTCs) APPEARANCE.	Are other DTCs being output?	Proceed with the diagnosis corresponding to DTC.	A temporary poor contact.

Diagnostics Procedure with Diagnostic Trouble Code (DTC)

ABS (DIAGNOSTIC)

X: DTC 44 ABS-AT CONTROL (CONTROLLED)

DIAGNOSIS:

Combination of AT control faults

TROUBLE SYMPTOM:

ABS does not operate.

WIRING DIAGRAM:

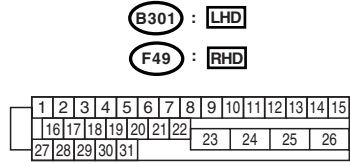
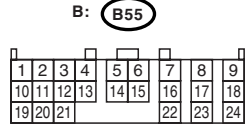
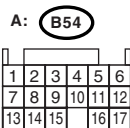
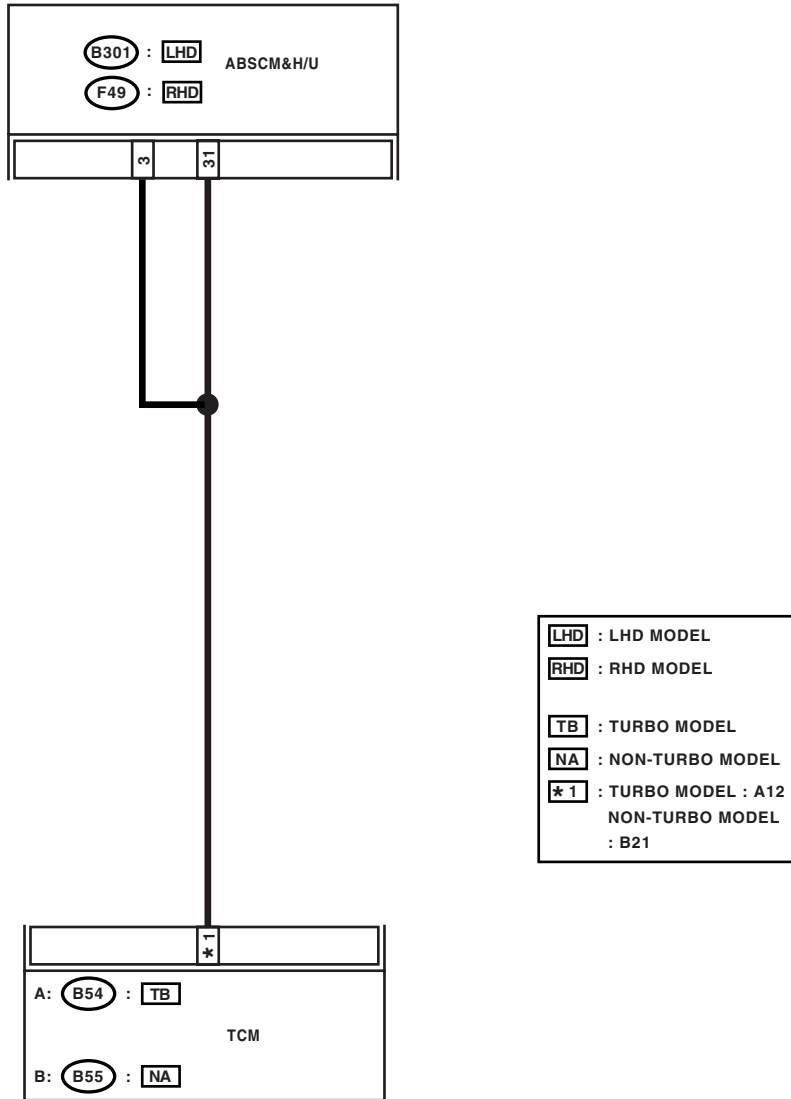

ABS00455

Diagnostics Procedure with Diagnostic Trouble Code (DTC)

ABS (DIAGNOSTIC)

Step	Check	Yes	No
1 CHECK BATTERY SHORT OF HARNESS. 1) Turn the ignition switch to OFF. 2) Disconnect all connectors from TCM. 3) Disconnect the connector from ABSCM&H/U. 4) Measure the voltage between ABSCM&H/U connector and chassis ground. Connector & terminal LHD: (B301) No. 3 (+) — Chassis ground (-): RHD: (F49) No. 3 (+) — Chassis ground (-):	Is the voltage less than 1 V?	Go to step 2.	Repair the harness between TCM and ABSCM&H/U.
2 CHECK BATTERY SHORT OF HARNESS. 1) Turn the ignition switch to ON. 2) Measure the voltage between ABSCM&H/U connector and chassis ground. Connector & terminal LHD: (B301) No. 3 (+) — Chassis ground (-): RHD: (F49) No. 3 (+) — Chassis ground (-):	Is the voltage less than 1 V?	Go to step 3.	Repair the harness between TCM and ABSCM&H/U.
3 CHECK OPEN CIRCUIT OF HARNESS. 1) Turn the ignition switch to OFF. 2) Connect all connectors to TCM. 3) Turn the ignition switch to ON. 4) Measure the voltage between ABSCM&H/U connector and chassis ground. Connector & terminal LHD: (B301) No. 3 (+) — Chassis ground (-): (B301) No. 31 (+) — Chassis ground (-): RHD: (F49) No. 3 (+) — Chassis ground (-): (F49) No. 31 (+) — Chassis ground (-):	Is the voltage 10 — 13 V?	Go to step 4.	Repair the harness/connector between TCM and ABSCM&H/U.
4 CHECK POOR CONTACT IN CONNECTORS. Turn the ignition switch to OFF.	Is there poor contact in connectors between TCM and ABSCM&H/U?	Repair the connector.	Go to step 5.
5 CHECK ABSCM&H/U. 1) Connect all connectors. 2) Erase the memory. 3) Perform the inspection mode. 4) Read out the DTC.	Is the same DTC as in current diagnosis still being output?	Replace the ABSCM only. <Ref. to ABS-8, ABSCM (ABS CONTROL MODULE), REPLACE, ABS Control Module and Hydraulic Control Unit (ABSCM&H/U).>	Go to step 6.
6 CHECK ANY OTHER DIAGNOSTIC TROUBLE CODES (DTCs) APPEARANCE.	Are other DTCs being output?	Proceed with the diagnosis corresponding to DTC.	A temporary poor contact.

Diagnostics Procedure with Diagnostic Trouble Code (DTC)

ABS (DIAGNOSTIC)

Y: DTC 51 VALVE RELAY MALFUNCTION

DIAGNOSIS:

Faulty valve relay

TROUBLE SYMPTOM:

- ABS does not operate.
- EBD does not operate.

NOTE:

In addition to the ABS warning light, brake warning light illuminates.

WIRING DIAGRAM:

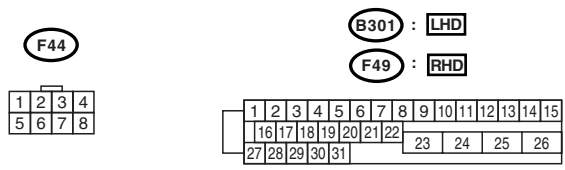
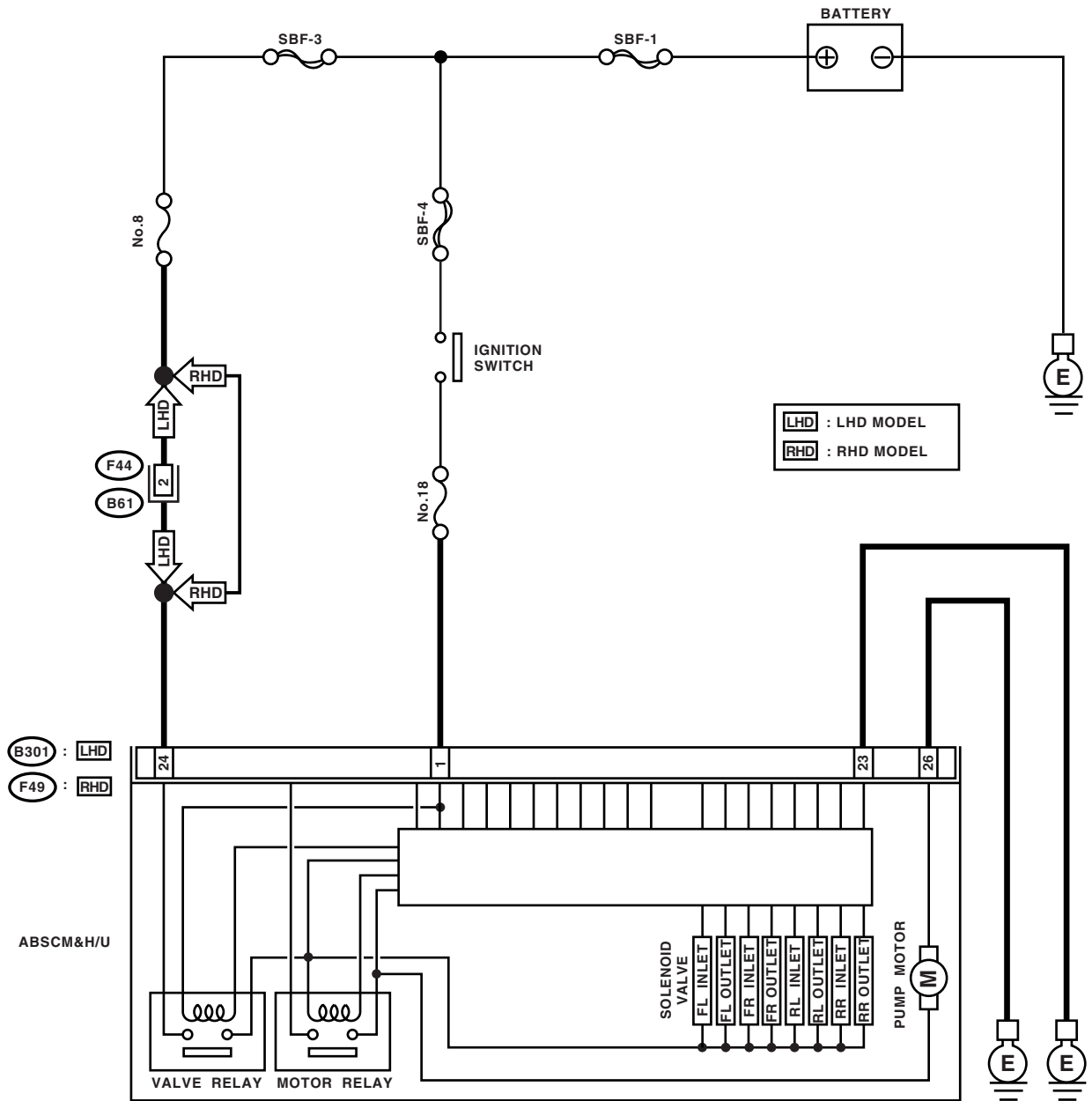

Diagnostics Procedure with Diagnostic Trouble Code (DTC)

ABS (DIAGNOSTIC)

Step	Check	Yes	No
1 CHECK INPUT VOLTAGE OF ABSCM&H/U. 1) Turn the ignition switch to OFF. 2) Disconnect the connector from ABSCM&H/U. 3) Run the engine at idle. 4) Measure the voltage between ABSCM&H/U connector and chassis ground. Connector & terminal LHD: (B301) No. 1 (+) — Chassis ground (-): (B301) No. 24 (+) — Chassis ground (-): RHD: (F49) No. 1 (+) — Chassis ground (-): (F49) No. 24 (+) — Chassis ground (-):	Is the voltage 10 — 15 V?	Go to step 2.	Repair the harness connector between battery and ABSCM&H/U.
2 CHECK GROUND CIRCUIT OF ABSCM&H/U. 1) Turn the ignition switch to OFF. 2) Measure the resistance between ABSCM&H/U connector and chassis ground. Connector & terminal LHD: (B301) No. 23 — Chassis ground: RHD: (F49) No. 23 — Chassis ground:	Is the resistance less than 0.5 Ω?	Go to step 3.	Repair the ABSCM&H/U ground harness.
3 CHECK POOR CONTACT IN CONNECTORS.	Is there poor contact in connectors between generator, battery and ABSCM&H/U?	Repair the connector.	Go to step 4.
4 CHECK ABSCM&H/U. 1) Connect all connectors. 2) Erase the memory. 3) Perform the inspection mode. 4) Read out the DTC.	Is the same DTC as in current diagnosis still being output?	Replace the ABSCM only. <Ref. to ABS-8, ABSCM (ABS CONTROL MODULE), REPLACE, ABS Control Module and Hydraulic Control Unit (ABSCM&H/U).>	Go to step 5.
5 CHECK ANY OTHER DIAGNOSTIC TROUBLE CODES (DTCs) APPEARANCE.	Are other DTCs being output?	Proceed with the diagnosis corresponding to DTC.	A temporary poor contact.

Diagnostics Procedure with Diagnostic Trouble Code (DTC)

ABS (DIAGNOSTIC)

Z: DTC 51 VALVE RELAY ON FAILURE

DIAGNOSIS:

Faulty valve relay

TROUBLE SYMPTOM:

ABS does not operate.

WIRING DIAGRAM:

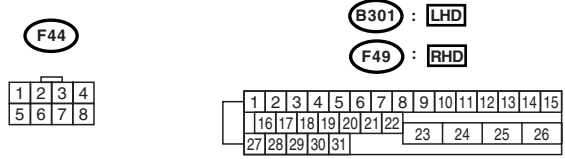
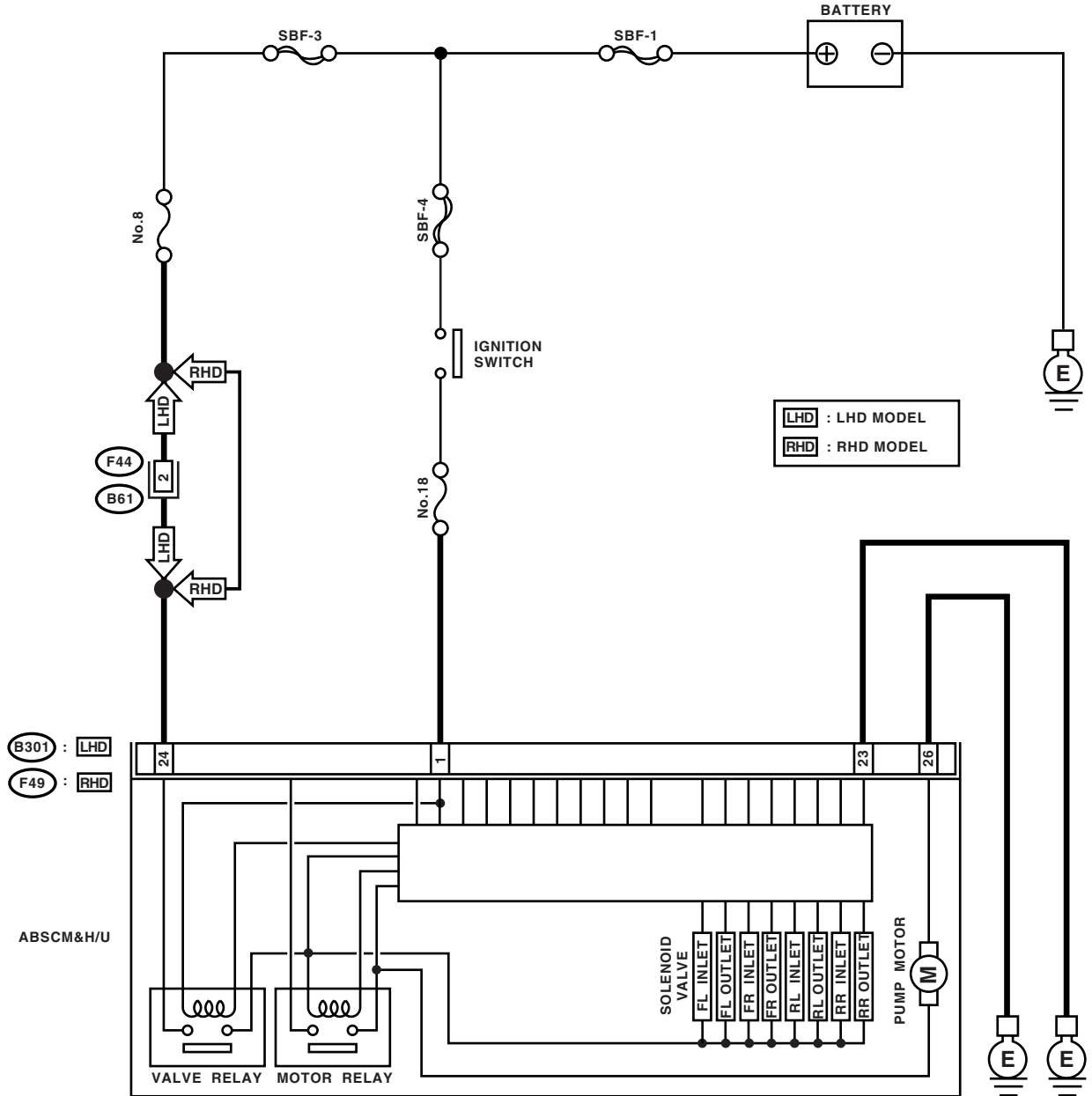

ABS00244

Diagnostics Procedure with Diagnostic Trouble Code (DTC)

ABS (DIAGNOSTIC)

Step	Check	Yes	No
1 CHECK VALVE RELAY IN ABSCM&H/U. 1) Disconnect the connector from ABSCM&H/U. 2) Measure the resistance between ABSCM&H/U terminals. <i>Terminals</i> <i>No. 23 — No. 24:</i>	Is the resistance more than 1 MΩ?	Go to step 2.	Replace the ABSCM&H/U. <Ref. to ABS-7, ABS Control Module and Hydraulic Control Unit (ABSCM&H/U).>
2 CHECK POOR CONTACT IN CONNECTORS.	Is there poor contact in connectors between generator, battery and ABSCM&H/U?	Repair the connector.	Go to step 3.
3 CHECK ABSCM&H/U. 1) Connect all connectors. 2) Erase the memory. 3) Perform the inspection mode. 4) Read out the DTC.	Is the same DTC as in current diagnosis still being output?	Replace the ABSCM&H/U. <Ref. to ABS-7, ABS Control Module and Hydraulic Control Unit (ABSCM&H/U).>	Go to step 4.
4 CHECK ANY OTHER DIAGNOSTIC TROUBLE CODES (DTCs) APPEARANCE.	Are other DTCs being output?	Proceed with the diagnosis corresponding to DTC.	A temporary poor contact.

Diagnostics Procedure with Diagnostic Trouble Code (DTC)

ABS (DIAGNOSTIC)

AA:DTC 52 OPEN CIRCUIT IN MOTOR RELAY CIRCUIT

DIAGNOSIS:

- Faulty motor
- Faulty motor relay
- Faulty harness connector

TROUBLE SYMPTOM:

ABS does not operate.

WIRING DIAGRAM:

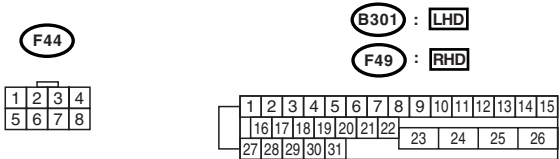
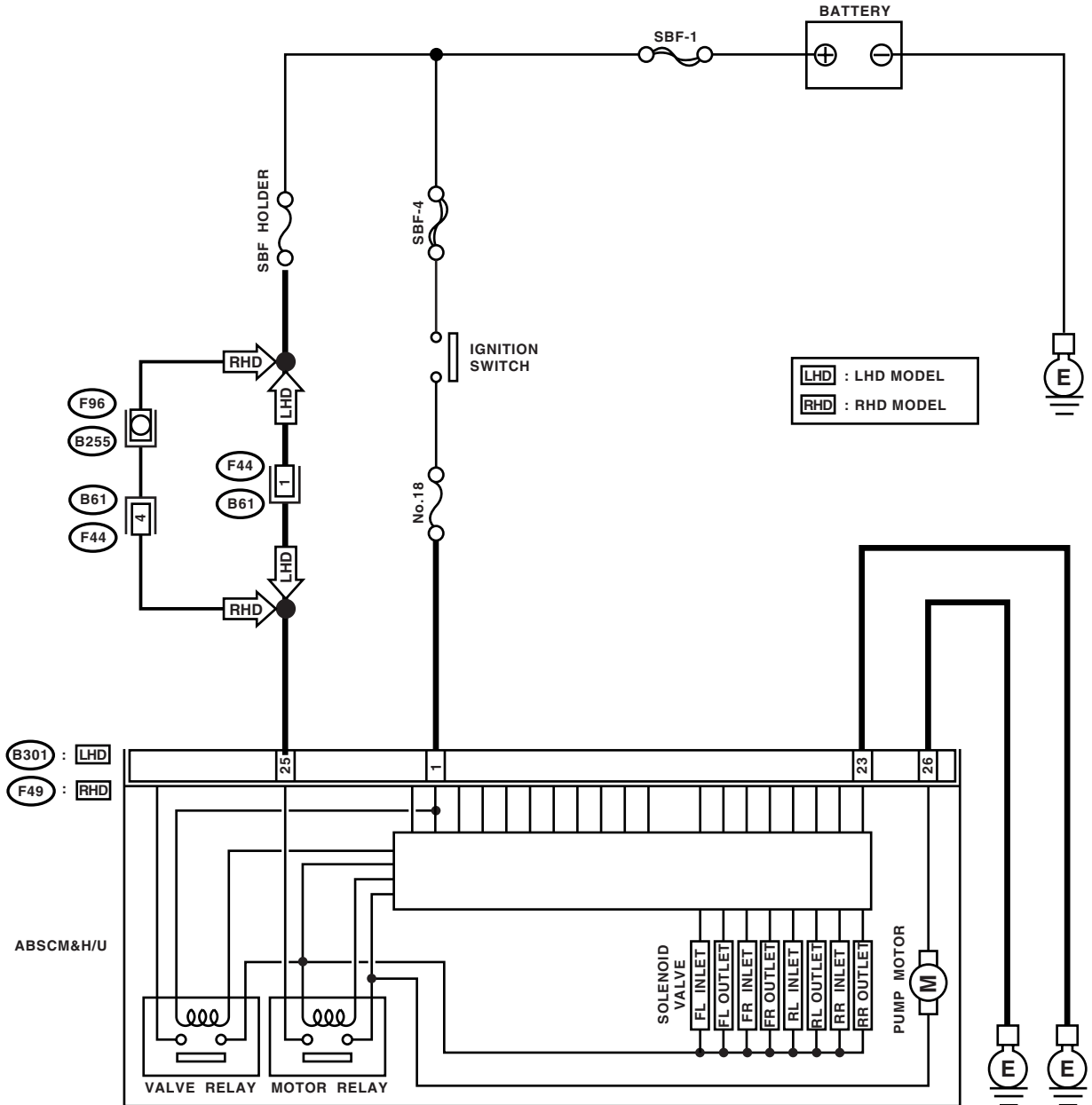

ABS00249

Diagnostics Procedure with Diagnostic Trouble Code (DTC)

ABS (DIAGNOSTIC)

Step	Check	Yes	No
1 CHECK INPUT VOLTAGE OF ABSCM&H/U. 1) Turn the ignition switch to OFF. 2) Disconnect the connector from ABSCM&H/U. 3) Turn the ignition switch to ON. 4) Measure the voltage between ABSCM&H/U connector and chassis ground. Connector & terminal LHD: (B301) No. 25 (+) — Chassis ground (-): RHD: (F49) No. 25 (+) — Chassis ground (-):	Is the voltage 10 — 13 V?	Go to step 2.	Repair the harness/connector between battery and ABSCM&H/U and check fuse SBF8.
2 CHECK GROUND CIRCUIT OF MOTOR. 1) Turn the ignition switch to OFF. 2) Measure the resistance between ABSCM&H/U connector and chassis ground. Connector & terminal LHD: (B301) No. 26 — Chassis ground: RHD: (F49) No. 26 — Chassis ground:	Is the resistance less than 0.5 Ω ?	Go to step 3.	Repair the ABSCM&H/U ground harness.
3 CHECK MOTOR OPERATION. Operate the sequence control. <Ref. to ABS-11, ABS Sequence Control.> NOTE: Use the diagnosis connector to operate sequence control.	Can motor revolution noise (buzz) be heard when carrying out the check sequence?	Go to step 4.	Replace the ABSCM&H/U. <Ref. to ABS-7, ABS Control Module and Hydraulic Control Unit (ABSCM&H/U).>
4 CHECK POOR CONTACT IN CONNECTORS. Turn the ignition switch to OFF.	Is there poor contact in connector between generator, battery and ABSCM&H/U?	Repair the connector.	Go to step 5.
5 CHECK ABSCM&H/U. 1) Connect all connectors. 2) Erase the memory. 3) Perform the inspection mode. 4) Read out the DTC.	Is the same DTC as in current diagnosis still being output?	Replace the ABSCM&H/U. <Ref. to ABS-7, ABS Control Module and Hydraulic Control Unit (ABSCM&H/U).>	Go to step 6.
6 CHECK ANY OTHER DIAGNOSTIC TROUBLE CODES (DTCs) APPEARANCE.	Are other DTCs being output?	Proceed with the diagnosis corresponding to DTC.	A temporary poor contact. NOTE: Although the ABS warning light remains illuminating at this point, this is a normal condition. Vehicle must be driven at approx. 12 km/h (7.46 MPH) or faster to turn off ABS warning light. Make sure that the ABS warning light goes off after driving vehicle.

Diagnostics Procedure with Diagnostic Trouble Code (DTC)

ABS (DIAGNOSTIC)

AB:DTC 52 MOTOR RELAY ON FAILURE

DIAGNOSIS:

- Faulty motor
- Faulty motor relay
- Faulty harness connector

TROUBLE SYMPTOM:

ABS does not operate.

WIRING DIAGRAM:

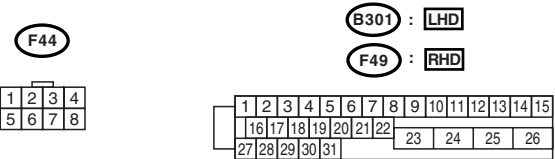
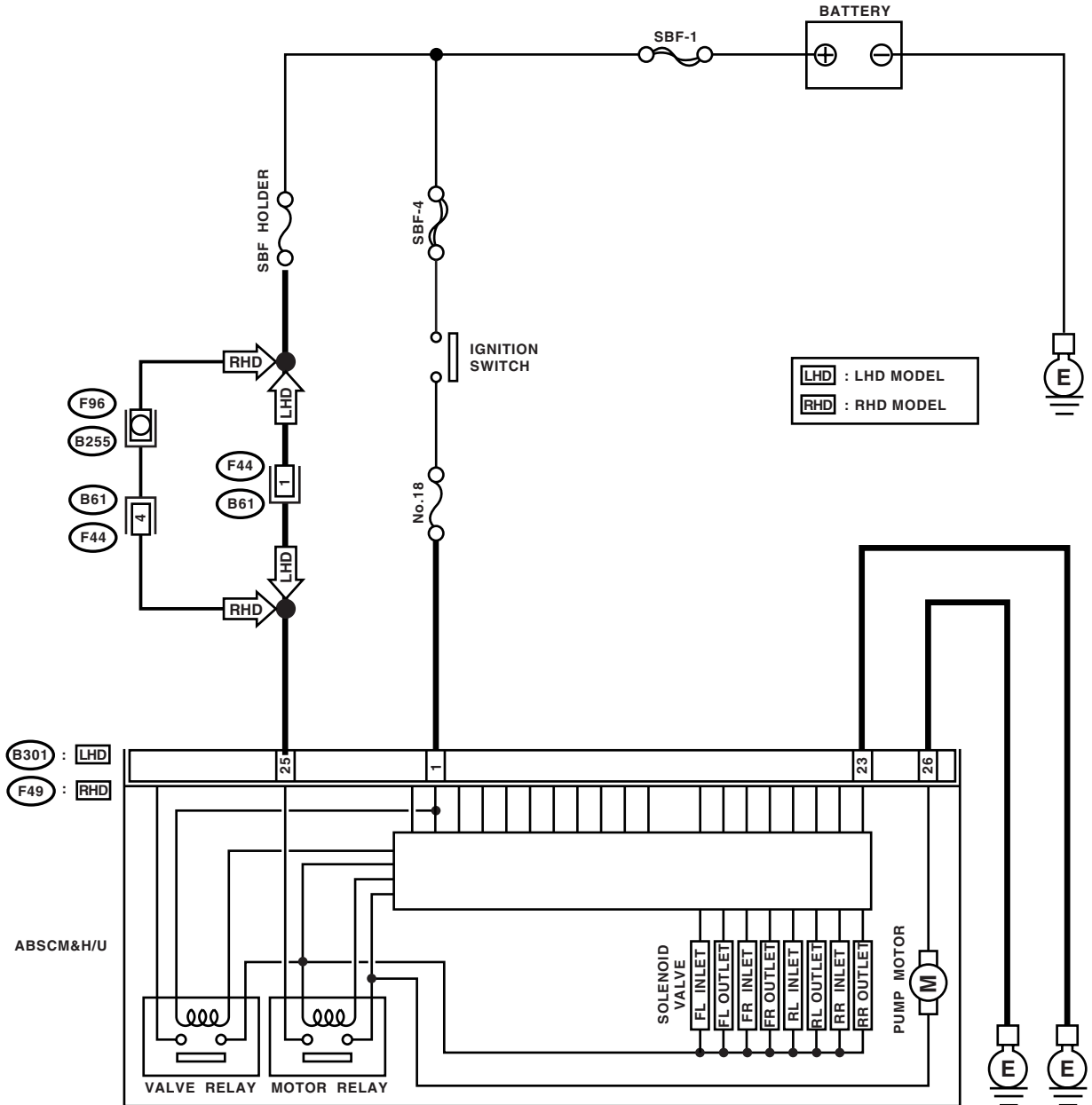

ABS00249

Diagnostics Procedure with Diagnostic Trouble Code (DTC)

ABS (DIAGNOSTIC)

Step	Check	Yes	No
1 CHECK MOTOR RELAY IN ABSCM&H/U. 1) Disconnect the connector from ABSCM&H/U. 2) Measure the resistance between ABSCM&H/U terminals. Terminals No. 25 — No. 26:	Is the resistance more than 1 MΩ?	Go to step 2.	Replace the ABSCM&H/U. <Ref. to ABS-7, ABS Control Module and Hydraulic Control Unit (ABSCM&H/U).>
2 CHECK MOTOR OPERATION. Operate the sequence control. <Ref. to ABS-11, ABS Sequence Control.> NOTE: Use the diagnosis connector to operate sequence control.	Can motor revolution noise (buzz) be heard when carrying out the sequence control?	Go to step 3.	Replace the ABSCM&H/U. <Ref. to ABS-7, ABS Control Module and Hydraulic Control Unit (ABSCM&H/U).>
3 CHECK POOR CONTACT IN CONNECTORS. Turn the ignition switch to OFF.	Is there poor contact in connector between generator, battery and ABSCM&H/U?	Repair the connector.	Go to step 4.
4 CHECK ABSCM&H/U. 1) Connect all connectors. 2) Erase the memory. 3) Perform the inspection mode. 4) Read out the DTC.	Is the same DTC as in current diagnosis still being output?	Replace the ABSCM&H/U. <Ref. to ABS-7, ABS Control Module and Hydraulic Control Unit (ABSCM&H/U).>	Go to step 5.
5 CHECK ANY OTHER DIAGNOSTIC TROUBLE CODES (DTCs) APPEARANCE.	Are other DTCs being output?	Proceed with the diagnosis corresponding to DTC.	A temporary poor contact. NOTE: Although the ABS warning light remains illuminating at this point, this is a normal condition. Vehicle must be driven at approx. 12 km/h (7.46 MPH) or faster to turn off ABS warning light. Make sure that the ABS warning light goes off after driving vehicle.

Diagnostics Procedure with Diagnostic Trouble Code (DTC)

ABS (DIAGNOSTIC)

AC:DTC 52 MOTOR MALFUNCTION

DIAGNOSIS:

- Faulty motor
- Faulty motor relay
- Faulty harness connector

TROUBLE SYMPTOM:

ABS does not operate.

WIRING DIAGRAM:

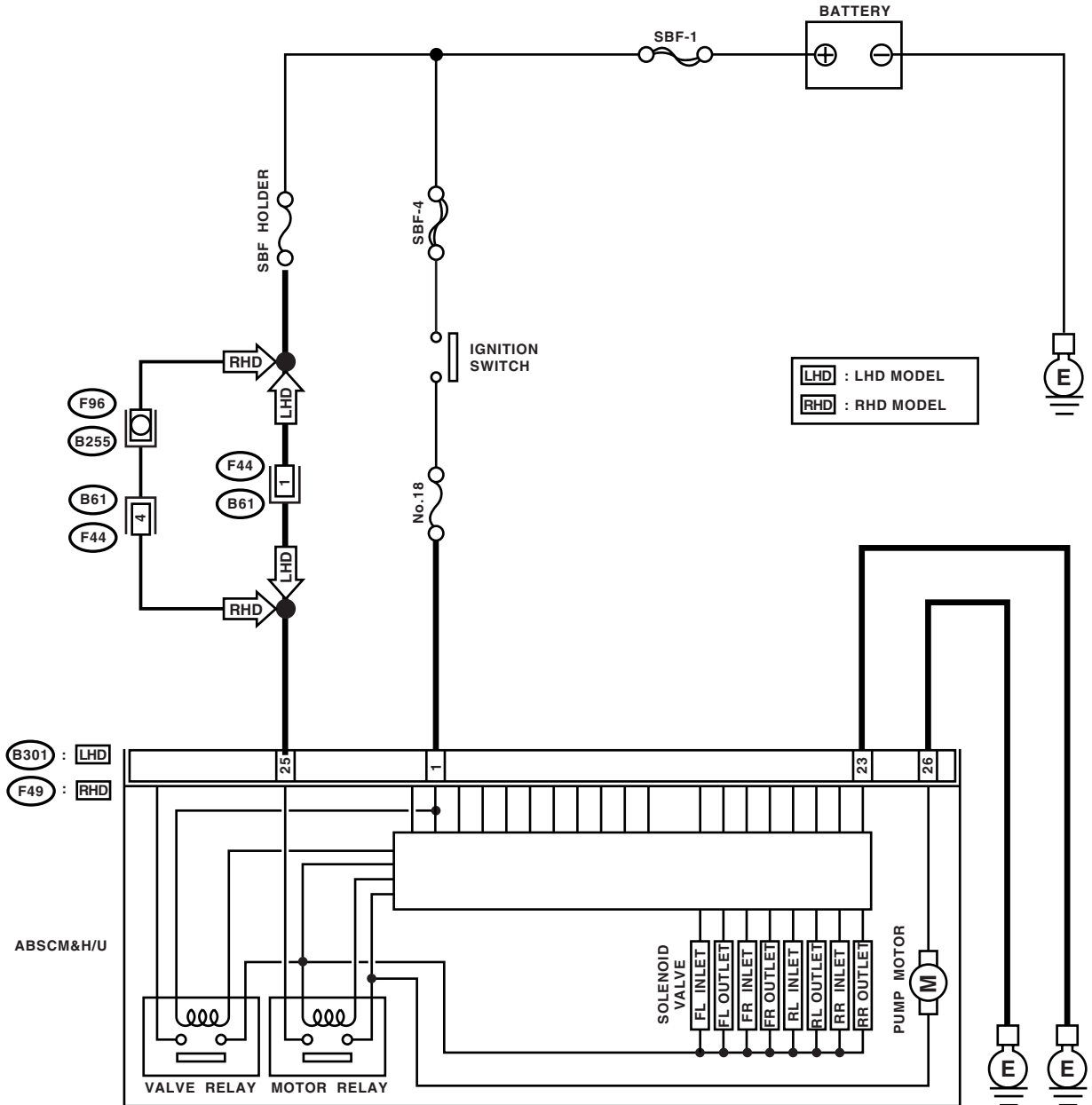

F44

B301 : LHD

F49 : RHD

1	2	3	4
5	6	7	8

1	2	3	4	5	6	7	8	9	10	11	12	13	14	15
16	17	18	19	20	21	22								
27	28	29	30	31				23	24	25	26			

ABS00249

Diagnostics Procedure with Diagnostic Trouble Code (DTC)

ABS (DIAGNOSTIC)

Step	Check	Yes	No
1 CHECK INPUT VOLTAGE OF ABSCM&H/U. 1) Turn the ignition switch to OFF. 2) Disconnect the connector from ABSCM&H/U. 3) Turn the ignition switch to ON. 4) Measure the voltage between ABSCM&H/U connector and chassis ground. Connector & terminal LHD: (B301) No. 25 (+) — Chassis ground (-): RHD: (F49) No. 25 (+) — Chassis ground (-):	Is the voltage 10 — 13 V?	Go to step 2.	Repair the harness/connector between battery and ABSCM&H/U and check fuse SBF8.
2 CHECK GROUND CIRCUIT OF MOTOR. 1) Turn the ignition switch to OFF. 2) Measure the resistance between ABSCM&H/U connector and chassis ground. Connector & terminal LHD: (B301) No. 26 — Chassis ground: RHD: (F49) No. 26 — Chassis ground:	Is the resistance less than 0.5 Ω?	Go to step 3.	Repair the ABSCM&H/U ground harness.
3 CHECK INPUT VOLTAGE OF ABSCM&H/U. 1) Run the engine at idle. 2) Measure the voltage between ABSCM&H/U connector and chassis ground. Connector & terminal LHD: (B301) No. 1 (+) — Chassis ground (-): RHD: (F49) No. 1 (+) — Chassis ground (-):	Is the voltage 10 — 15 V?	Go to step 4.	Repair the harness connector between battery, ignition switch and ABSCM&H/U.
4 CHECK GROUND CIRCUIT OF ABSCM&H/U. 1) Turn the ignition switch to OFF. 2) Measure the resistance between ABSCM&H/U connector and chassis ground. Connector & terminal LHD: (B301) No. 23 — Chassis ground: RHD: (F49) No. 23 — Chassis ground:	Is the resistance less than 0.5 Ω?	Go to step 5.	Repair the ABSCM&H/U ground harness.
5 CHECK MOTOR OPERATION. Operate the sequence control. <Ref. to ABS-11, ABS Sequence Control.> NOTE: Use the diagnosis connector to operate sequence control.	Can motor revolution noise (buzz) be heard when carrying out the sequence control?	Go to step 6.	Replace the ABSCM&H/U. <Ref. to ABS-7, ABS Control Module and Hydraulic Control Unit (ABSCM&H/U).>
6 CHECK POOR CONTACT IN CONNECTORS. Turn the ignition switch to OFF.	Is there poor contact in connector between generator, battery and ABSCM&H/U?	Repair the connector.	Go to step 7.
7 CHECK ABSCM&H/U. 1) Connect all connectors. 2) Erase the memory. 3) Perform the inspection mode. 4) Read out the DTC.	Is the same DTC as in current diagnosis still being output?	Replace the ABSCM&H/U. <Ref. to ABS-7, ABS Control Module and Hydraulic Control Unit (ABSCM&H/U).>	Go to step 8.

Diagnosics Procedure with Diagnostic Trouble Code (DTC)

ABS (DIAGNOSTIC)

Step	Check	Yes	No
8 CHECK ANY OTHER DIAGNOSTIC TROUBLE CODES (DTCs) APPEARANCE.	Are other DTCs being output?	Proceed with the diagnosis corresponding to DTC.	A temporary poor contact. NOTE: Although the ABS warning light remains illuminating at this point, this is a normal condition. Vehicle must be driven at approx. 12 km/h (7.46 MPH) or faster to turn off ABS warning light. Make sure that the ABS warning light goes off after driving vehicle.

AD:DTC 54 STOP LIGHT SWITCH SIGNAL CIRCUIT MALFUNCTION

DIAGNOSIS:

Faulty stop light switch

TROUBLE SYMPTOM:

ABS does not operate.

WIRING DIAGRAM:

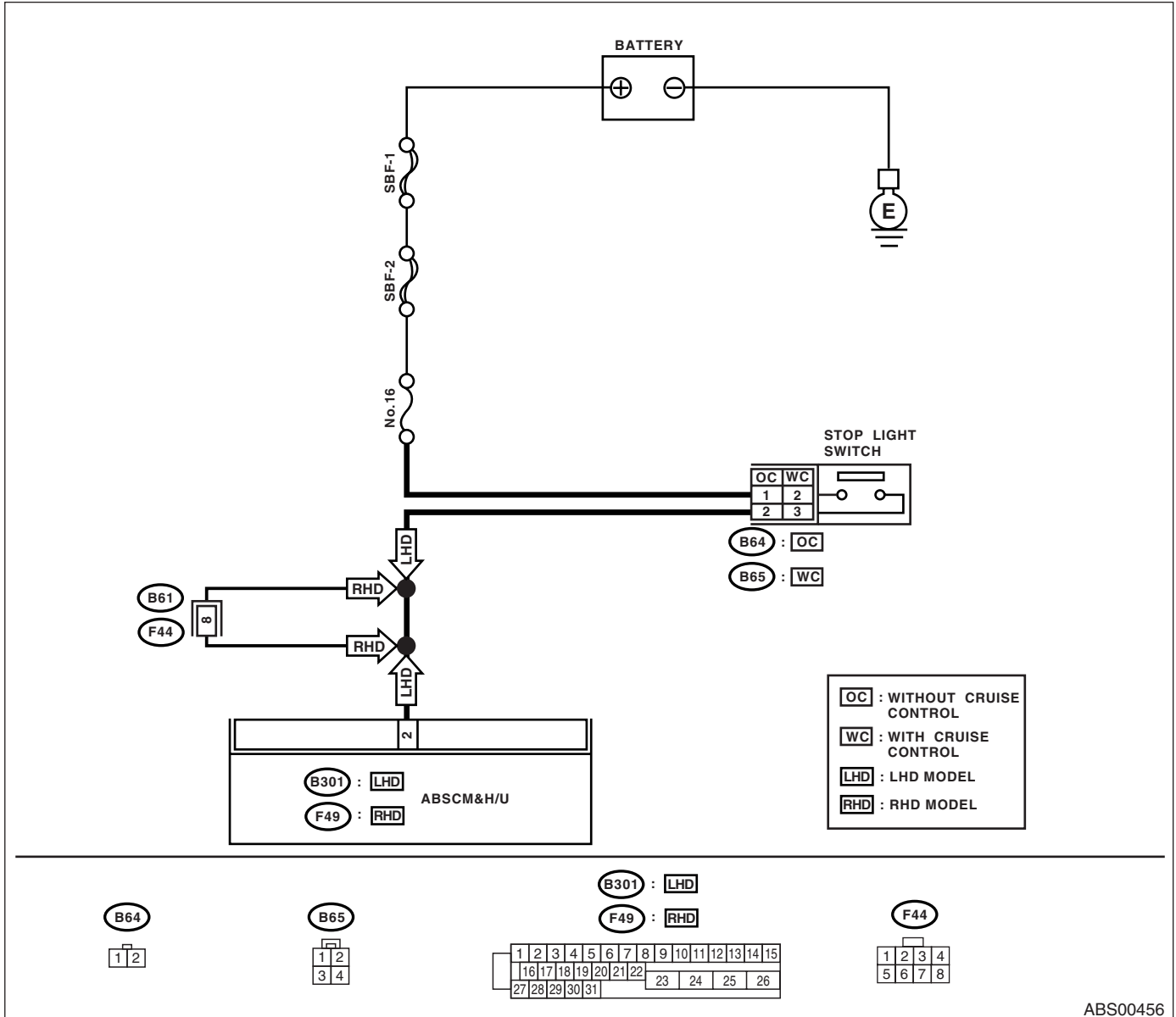

ABS00456

Diagnostics Procedure with Diagnostic Trouble Code (DTC)

ABS (DIAGNOSTIC)

Step	Check	Yes	No
1 CHECK OUTPUT OF STOP LIGHT SWITCH USING SUBARU SELECT MONITOR. 1) Select "Current data display & Save" on the SUBARU select monitor. 2) Release the brake pedal. 3) Read the stop light switch output in select monitor data display.	Is the reading indicated on monitor display less than 1.5 V?	Go to step 2.	Go to step 3.
2 CHECK OUTPUT OF STOP LIGHT SWITCH USING SELECT MONITOR. 1) Depress the brake pedal. 2) Read the stop light switch output in SUBARU select monitor data display.	Is the reading indicated on monitor display 10 — 15 V?	Go to step 5.	Go to step 3.
3 CHECK IF STOP LIGHTS COME ON. Depress the brake pedal.	Do the stop lights turn on?	Go to step 4.	Repair the stop lights circuit.
4 CHECK OPEN CIRCUIT IN HARNESS. 1) Turn the ignition switch to OFF. 2) Disconnect the connector from ABSCM&H/U. 3) Depress the brake pedal. 4) Measure the voltage between ABSCM&H/U connector and chassis ground. Connector & terminal LHD: (B301) No. 2 (+) — Chassis ground (-): RHD: (F49) No. 2 (+) — Chassis ground (-):	Is the voltage 10 — 15 V?	Go to step 5.	Repair the harness between stop light switch and ABSCM&H/U connector.
5 CHECK POOR CONTACT IN CONNECTORS.	Is there poor contact in connector between stop light switch and ABSCM&H/U?	Repair the connector.	Go to step 6.
6 CHECK ABSCM&H/U. 1) Connect all connectors. 2) Erase the memory. 3) Perform the inspection mode. 4) Read out the DTC.	Is the same DTC as in current diagnosis still being output?	Replace the ABSCM only. <Ref. to ABS-8, ABSCM (ABS CONTROL MODULE), REPLACE, ABS Control Module and Hydraulic Control Unit (ABSCM&H/U).>	Go to step 7.
7 CHECK ANY OTHER DIAGNOSTIC TROUBLE CODES (DTCs) APPEARANCE.	Are other DTCs being output?	Proceed with the diagnosis corresponding to DTC.	A temporary poor contact.

AE:DTC 56 OPEN OR SHORT CIRCUIT IN G SENSOR CIRCUIT

DIAGNOSIS:

Faulty G sensor output voltage

TROUBLE SYMPTOM:

ABS does not operate.

WIRING DIAGRAM:

- LHD model

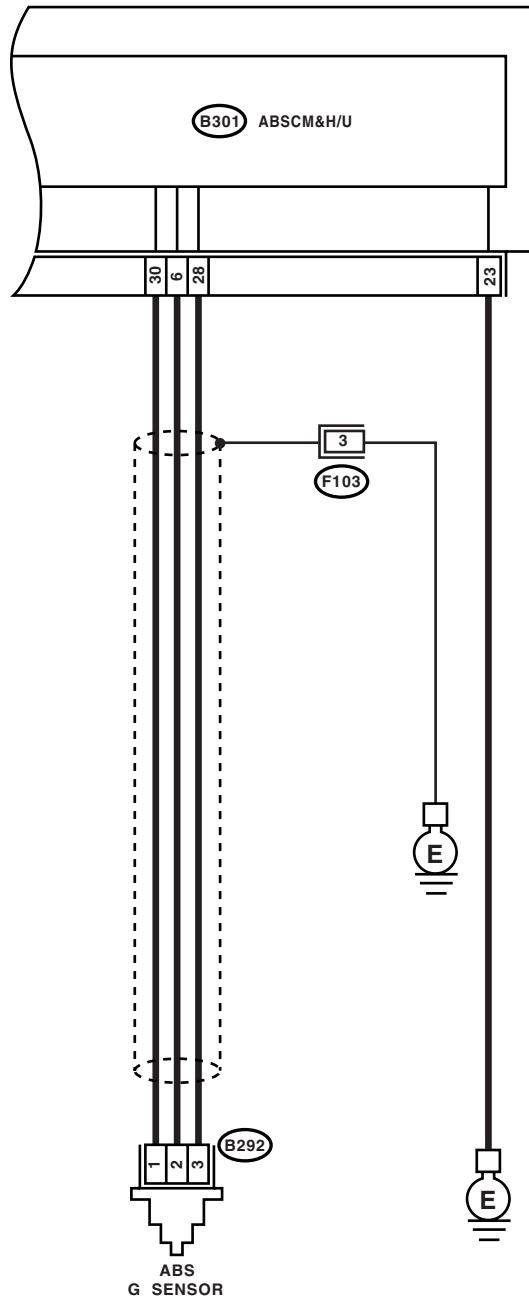

(B292)



(F103)



(B301)

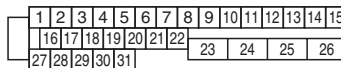

ABS00457

Diagnostics Procedure with Diagnostic Trouble Code (DTC)

ABS (DIAGNOSTIC)

- RHD model

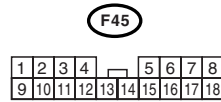
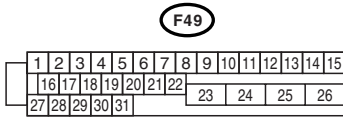
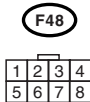
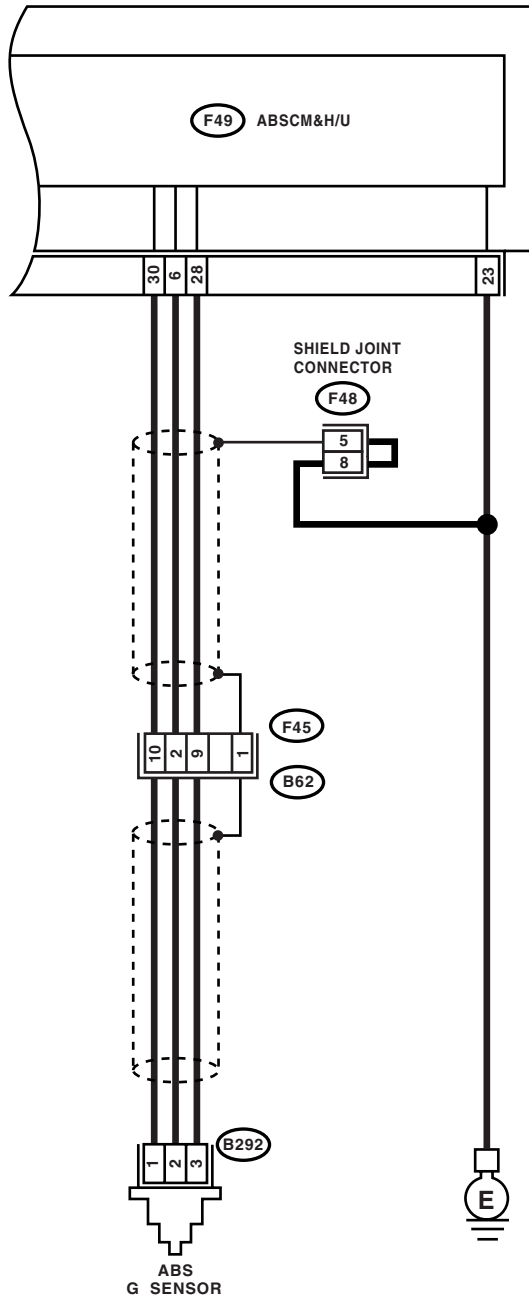

ABS00264

Diagnostics Procedure with Diagnostic Trouble Code (DTC)

ABS (DIAGNOSTIC)

Step	Check	Yes	No
1 CHECK OUTPUT OF G SENSOR USING SELECT MONITOR. 1) Select "Current data display & Save" on the select monitor. 2) Read the G sensor output in select monitor data display.	Is the G sensor output on monitor display 2.1 — 2.5 V when G sensor is in horizontal position?	Go to step 2.	Go to step 5.
2 CHECK POOR CONTACT IN CONNECTORS.	Is there poor contact in connector between ABSCM&H/U and G sensor?	Repair the connector.	Go to step 3.
3 CHECK ABSCM&H/U. 1) Connect all connectors. 2) Erase the memory. 3) Perform the inspection mode. 4) Read out the DTC.	Is the same DTC as in the current diagnosis still being output?	Replace the ABSCM only. <Ref. to ABS-8, ABSCM (ABS CONTROL MODULE), REPLACE, ABS Control Module and Hydraulic Control Unit (ABSCM&H/U).>	Go to step 4.
4 CHECK ANY OTHER DIAGNOSTIC TROUBLE CODES (DTCs) APPEARANCE.	Are other DTCs being output?	Proceed with the diagnosis corresponding to DTC.	A temporary poor contact.
5 CHECK INPUT VOLTAGE OF G SENSOR. 1) Turn the ignition switch to OFF. 2) Remove the console box. 3) Remove the G sensor from vehicle. (Do not disconnect connector.) 4) Turn the ignition switch to ON. 5) Measure the voltage between G sensor connector terminals. <i>Connector & terminal</i> <i>(B292) No. 1 (+) — No. 3 (-):</i>	Is the voltage 4.75 — 5.25 V?	Go to step 6.	Repair the harness/connector between G sensor and ABSCM&H/U.
6 CHECK OPEN CIRCUIT IN G SENSOR OUTPUT HARNESS AND GROUND HARNESS. 1) Turn the ignition switch to OFF. 2) Disconnect the connector from ABSCM&H/U. 3) Measure the resistance between ABSCM&H/U connector terminals. <i>Connector & terminal</i> <i>LHD: (B301) No. 6 — No. 28:</i> <i>RHD: (F49) No. 6 — No. 28:</i>	Is the resistance 5.0 — 5.6 kΩ?	Go to step 7.	Repair the harness/connector between G sensor and ABSCM&H/U.
7 CHECK GROUND SHORT IN G SENSOR OUTPUT HARNESS. 1) Disconnect the connector from G sensor. 2) Measure the resistance between ABSCM&H/U connector and chassis ground. <i>Connector & terminal</i> <i>LHD: (B301) No. 6 — Chassis ground:</i> <i>RHD: (F49) No. 6 — Chassis ground:</i>	Is the resistance more than 1 MΩ?	Go to step 8.	Repair the harness between G sensor and ABSCM&H/U.
8 CHECK G SENSOR. 1) Connect the connector to G sensor. 2) Connect the connector to ABSCM&H/U. 3) Turn the ignition switch to ON. 4) Measure the voltage between G sensor connector terminals. <i>Connector & terminal</i> <i>(B292) No. 2 (+) — No. 3 (-):</i>	Is the voltage 2.1 — 2.5 V when G sensor is in horizontal position?	Go to step 9.	Replace the G sensor. <Ref. to ABS-23, G Sensor.>

Diagnostics Procedure with Diagnostic Trouble Code (DTC)

ABS (DIAGNOSTIC)

Step	Check	Yes	No
9 CHECK G SENSOR. Measure the voltage between G sensor connector terminals. <i>Connector & terminal</i> <i>(B292) No. 2 (+) — No. 3 (-):</i>	Is the voltage 3.7 — 4.1 V when G sensor is inclined forwards to 90°?	Go to step 10.	Replace the G sensor. <Ref. to ABS-23, G Sensor.>
10 CHECK G SENSOR. Measure the voltage between G sensor connector terminals. <i>Connector & terminal</i> <i>(B292) No. 2 (+) — No. 3 (-):</i>	Is the voltage 0.5 — 0.9 V when G sensor is inclined backwards to 90°?	Go to step 11.	Replace the G sensor. <Ref. to ABS-23, G Sensor.>
11 CHECK POOR CONTACT IN CONNECTORS. Turn the ignition switch to OFF.	Is there poor contact in connector between ABSCM&H/U and G sensor?	Repair the connector.	Go to step 12.
12 CHECK ABSCM&H/U. 1) Connect all connectors. 2) Erase the memory. 3) Perform the inspection mode. 4) Read out the DTC.	Is the same DTC as in current diagnosis still being output?	Replace the ABSCM only. <Ref. to ABS-8, ABSCM (ABS CONTROL MODULE), REPLACE, ABS Control Module and Hydraulic Control Unit (ABSCM&H/U).>	Go to step 13.
13 CHECK ANY OTHER DIAGNOSTIC TROUBLE CODES (DTCs) APPEARANCE.	Are other DTCs being output?	Proceed with the diagnosis corresponding to DTC.	A temporary poor contact.

AF:DTC 56 BATTERY SHORT IN G SENSOR CIRCUIT

DIAGNOSIS:

Faulty G sensor output voltage

TROUBLE SYMPTOM:

ABS does not operate.

WIRING DIAGRAM:

- LHD model

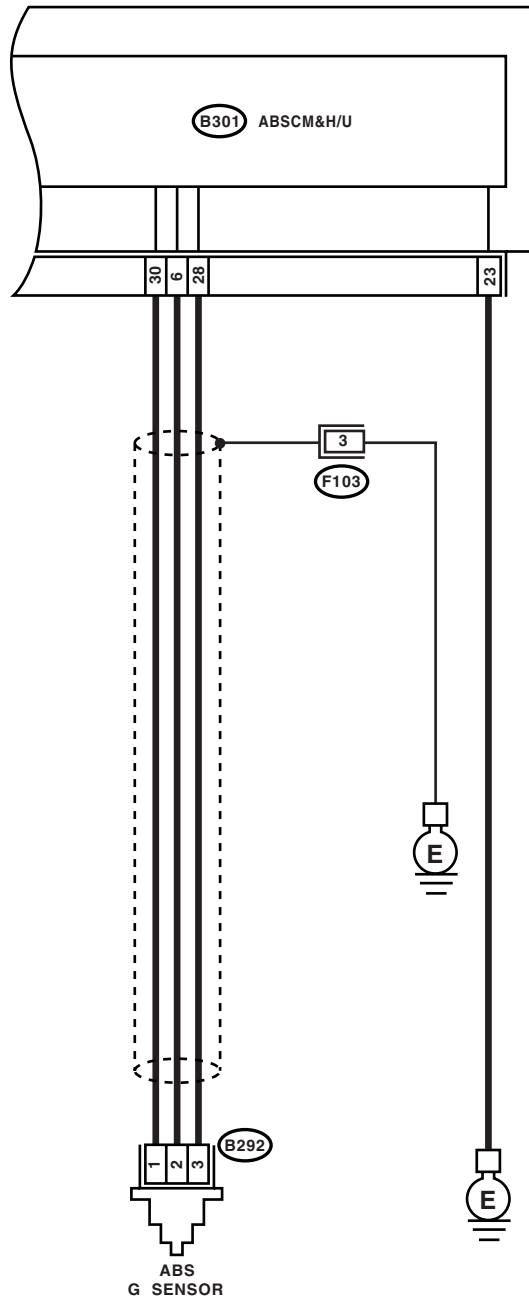

(B292)

1	2	3
---	---	---

(F103)

1	2	3	4
5	6	7	8

(B301)

1	2	3	4	5	6	7	8	9	10	11	12	13	14	15
16	17	18	19	20	21	22	23	24	25	26				
27	28	29	30	31										

Diagnostics Procedure with Diagnostic Trouble Code (DTC)

ABS (DIAGNOSTIC)

- RHD model

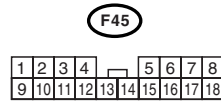
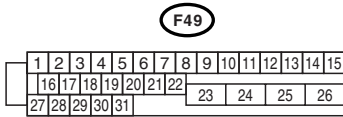
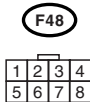
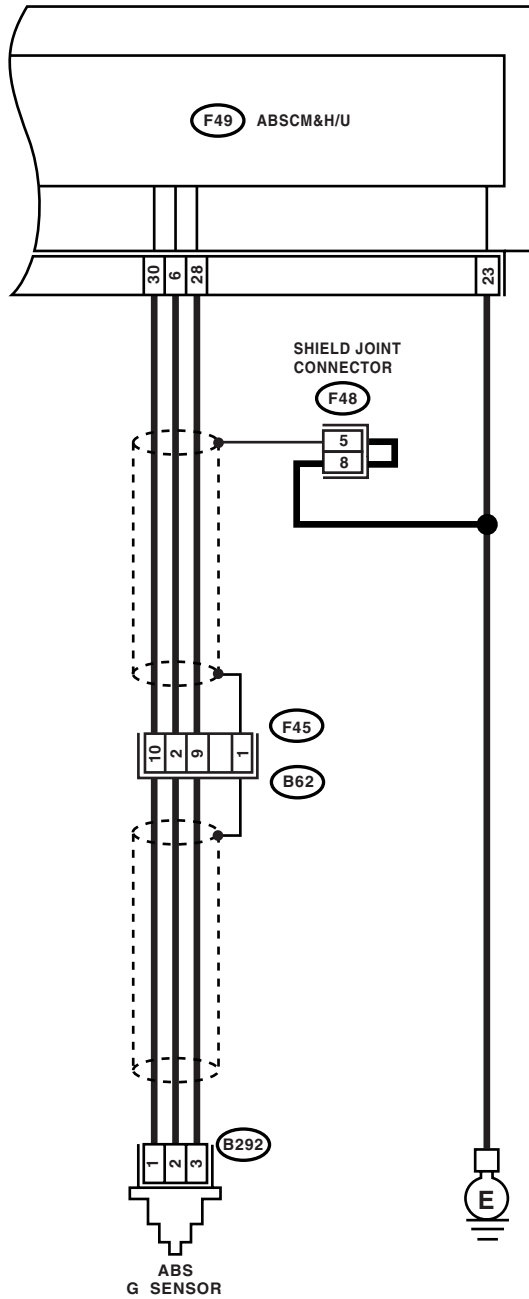

ABS00264

Diagnostics Procedure with Diagnostic Trouble Code (DTC)

ABS (DIAGNOSTIC)

Step	Check	Yes	No
1 CHECK OUTPUT OF G SENSOR USING SELECT MONITOR. 1) Select "Current data display & Save" on the select monitor. 2) Read the G sensor output in select monitor data display.	Is the voltage 2.1 — 2.5 V when G sensor is in horizontal position?	Go to step 2.	Go to step 5.
2 CHECK POOR CONTACT IN CONNECTORS.	Is there poor contact in connector between ABSCM&H/U and G sensor?	Repair the connector.	Go to step 3.
3 CHECK ABSCM&H/U. 1) Connect all connectors. 2) Erase the memory. 3) Perform the inspection mode. 4) Read out the DTC.	Is the same DTC as in current diagnosis still being output?	Replace the ABSCM only. <Ref. to ABS-8, ABSCM (ABS CONTROL MODULE), REPLACE, ABS Control Module and Hydraulic Control Unit (ABSCM&H/U).>	Go to step 4.
4 CHECK ANY OTHER DIAGNOSTIC TROUBLE CODES (DTCs) APPEARANCE.	Are other DTCs being output?	Proceed with the diagnosis corresponding to DTC.	A temporary poor contact.
5 CHECK FREEZE FRAME DATA. 1) Select "Freeze frame data" on the select monitor. 2) Read front right wheel speed on the select monitor display.	Is the front right wheel speed on monitor display 0 km/h (0 MPH)?	Go to step 6.	Go to step 16.
6 CHECK FREEZE FRAME DATA. Read front left wheel speed on the select monitor display.	Is the front left wheel speed on monitor display 0 km/h (0 MPH)?	Go to step 7.	Go to step 16.
7 CHECK FREEZE FRAME DATA. Read rear right wheel speed on the select monitor display.	Is the rear right wheel speed on monitor display 0 km/h (0 MPH)?	Go to step 8.	Go to step 16.
8 CHECK FREEZE FRAME DATA. Read rear left wheel speed on the select monitor display.	Is the rear left wheel speed on monitor display 0 km/h (0 MPH)?	Go to step 9.	Go to step 16.
9 CHECK FREEZE FRAME DATA. Read G sensor output on the select monitor display.	Is the G sensor output on monitor display more than 3.65 V?	Go to step 10.	Go to step 16.
10 CHECK OPEN CIRCUIT IN G SENSOR OUTPUT HARNESS AND GROUND HARNESS. 1) Turn the ignition switch to OFF. 2) Disconnect the connector from ABSCM&H/U. 3) Measure the resistance between ABSCM&H/U connector terminals. Connector & terminal LHD: (B301) No. 6 — No. 28: RHD: (F49) No. 6 — No. 28:	Is the resistance 4.3 — 4.9 kΩ?	Go to step 11.	Repair the harness/connector between G sensor and ABSCM&H/U.

Diagnostics Procedure with Diagnostic Trouble Code (DTC)

ABS (DIAGNOSTIC)

Step	Check	Yes	No
11 CHECK BATTERY SHORT OF HARNESS. 1) Turn the ignition switch to OFF. 2) Remove the console box. 3) Disconnect the connector from G sensor. 4) Disconnect the connector from ABSCM&H/U. 5) Measure the voltage between ABSCM&H/U connector and chassis ground. Connector & terminal LHD: (B301) No. 6 (+) — Chassis ground (-): RHD: (F49) No. 6 (+) — Chassis ground (-):	Is the voltage less than 1 V?	Go to step 12.	Repair the harness between G sensor and ABSCM&H/U.
12 CHECK BATTERY SHORT OF HARNESS. 1) Turn the ignition switch to ON. 2) Measure the voltage between ABSCM&H/U connector and chassis ground. Connector & terminal LHD: (B301) No. 6 (+) — Chassis ground (-): RHD: (F49) No. 6 (+) — Chassis ground (-):	Is the voltage less than 1 V?	Go to step 13.	Repair the harness between G sensor and ABSCM&H/U.
13 CHECK POOR CONTACT IN CONNECTORS.	Is there poor contact in connector between ABSCM&H/U and G sensor?	Repair the connector.	Go to step 14.
14 CHECK ABSCM&H/U. 1) Connect all connectors. 2) Erase the memory. 3) Perform the inspection mode. 4) Read out the DTC.	Is the same DTC as in current diagnosis still being output?	Replace the ABSCM only. <Ref. to ABS-8, ABSCM (ABS CONTROL MODULE), REPLACE, ABS Control Module and Hydraulic Control Unit (ABSCM&H/U).>	Go to step 15.
15 CHECK ANY OTHER DIAGNOSTIC TROUBLE CODES (DTCs) APPEARANCE.	Are other DTCs being output?	Proceed with the diagnosis corresponding to DTC.	A temporary poor contact.
16 CHECK INPUT VOLTAGE OF G SENSOR. 1) Turn the ignition switch to OFF. 2) Remove the console box. 3) Remove the G sensor from vehicle. (Do not disconnect connector.) 4) Turn the ignition switch to ON. 5) Measure the voltage between G sensor connector terminals. Connector & terminal (B292) No. 1 (+) — No. 3 (-):	Is the voltage 4.75 — 5.25 V?	Go to step 17.	Repair the harness/connector between G sensor and ABSCM&H/U.
17 CHECK OPEN CIRCUIT IN G SENSOR OUTPUT HARNESS AND GROUND HARNESS. 1) Turn the ignition switch to OFF. 2) Disconnect the connector from ABSCM&H/U. 3) Measure the resistance between ABSCM&H/U connector terminals. Connector & terminal LHD: (B301) No. 6 — No. 28: RHD: (F49) No. 6 — No. 28:	Is the resistance 5.0 — 5.6 kΩ?	Go to step 18.	Repair the harness/connector between G sensor and ABSCM&H/U.

Diagnostics Procedure with Diagnostic Trouble Code (DTC)

ABS (DIAGNOSTIC)

Step	Check	Yes	No
18 CHECK G SENSOR. 1) Connect the connector to G sensor. 2) Connect the connector to ABSCM&H/U. 3) Turn the ignition switch to ON. 4) Measure the voltage between G sensor connector terminals. <i>Connector & terminal</i> <i>(B292) No. 2 (+) — No. 3 (-):</i>	Is the voltage 2.1 — 2.5 V when G sensor is in horizontal position?	Go to step 19 .	Replace the G sensor. <Ref. to ABS-23, G Sensor.>
19 CHECK G SENSOR. Measure the voltage between G sensor connector terminals. <i>Connector & terminal</i> <i>(B292) No. 2 (+) — No. 3 (-):</i>	Is the voltage 3.7 — 4.1 V when G sensor is inclined forwards to 90°?	Go to step 20 .	Replace the G sensor. <Ref. to ABS-23, G Sensor.>
20 CHECK G SENSOR. Measure the voltage between G sensor connector terminals. <i>Connector & terminal</i> <i>(B292) No. 2 (+) — No. 3 (-):</i>	Is the voltage 0.5 — 0.9 V when G sensor is inclined backwards to 90°?	Go to step 21 .	Replace the G sensor. <Ref. to ABS-23, G Sensor.>
21 CHECK POOR CONTACT IN CONNECTORS. Turn the ignition switch to OFF.	Is there poor contact in connector between ABSCM&H/U and G sensor?	Repair the connector.	Go to step 22 .
22 CHECK ABSCM&H/U. 1) Connect all connectors. 2) Erase the memory. 3) Perform the inspection mode. 4) Read out the DTC.	Is the same DTC as in current diagnosis still being output?	Replace the ABSCM only. <Ref. to ABS-8, ABSCM (ABS CONTROL MODULE), REPLACE, ABS Control Module and Hydraulic Control Unit (ABSCM&H/U).>	Go to step 23 .
23 CHECK ANY OTHER DIAGNOSTIC TROUBLE CODES (DTCs) APPEARANCE.	Are other DTCs being output?	Proceed with the diagnosis corresponding to DTC.	A temporary poor contact.

Diagnostics Procedure with Diagnostic Trouble Code (DTC)

ABS (DIAGNOSTIC)

AG:DTC 56 ABNORMAL G SENSOR HIGH μ OUTPUT

DIAGNOSIS:

Faulty G sensor output voltage

TROUBLE SYMPTOM:

ABS does not operate.

WIRING DIAGRAM:

- LHD model

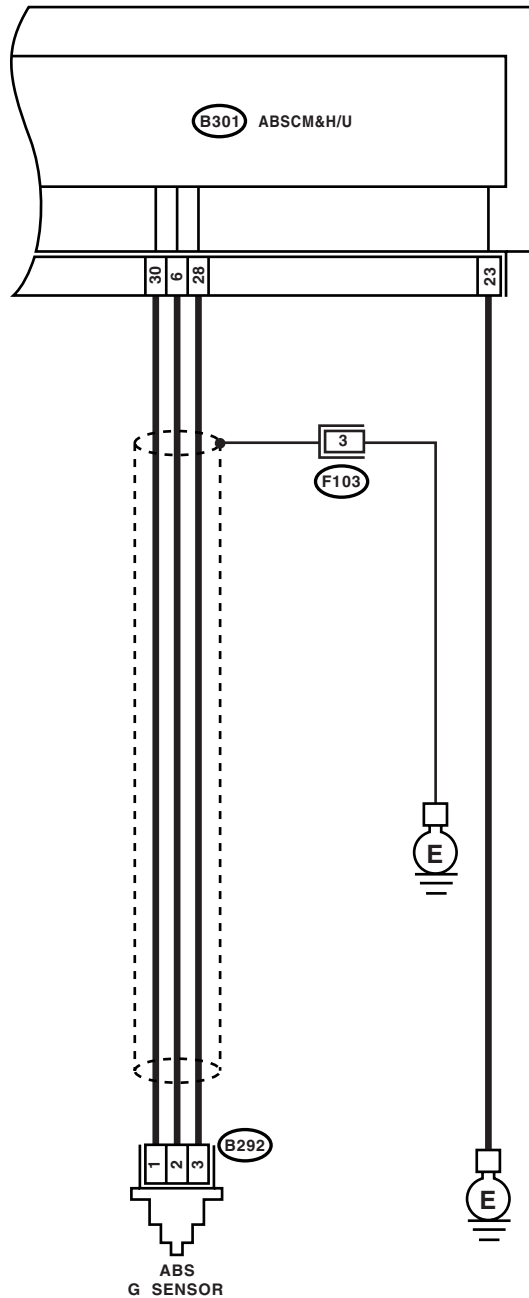

B292

1	2	3
---	---	---

F103

1	2	3	4
5	6	7	8

B301

1	2	3	4	5	6	7	8	9	10	11	12	13	14	15
16	17	18	19	20	21	22	23	24	25	26				
27	28	29	30	31										

ABS00457

Diagnostics Procedure with Diagnostic Trouble Code (DTC)

ABS (DIAGNOSTIC)

- RHD model

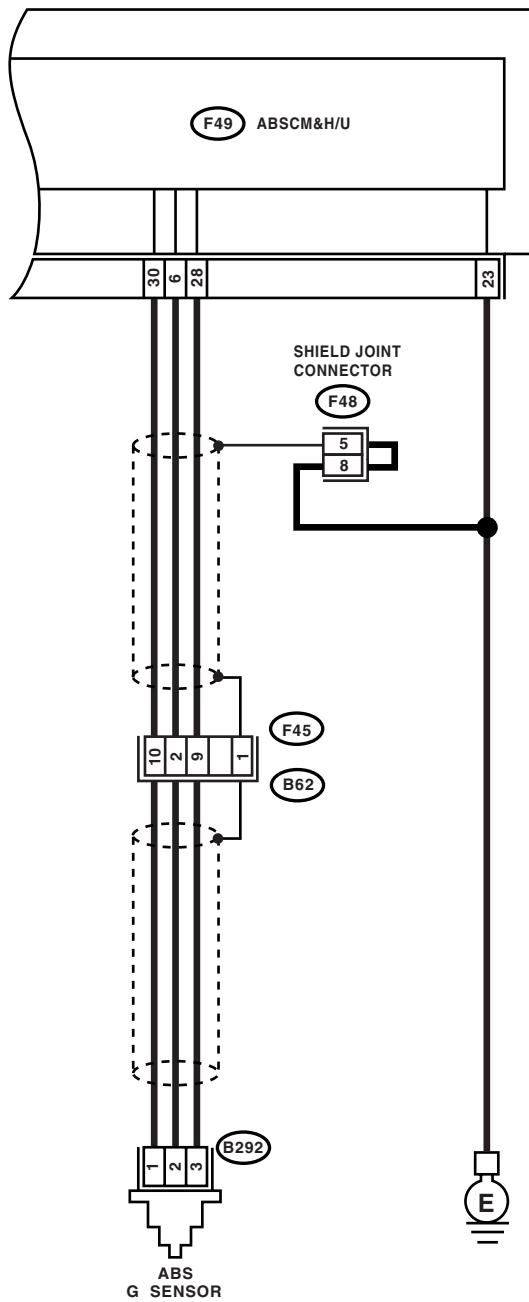

(B292)

1	2	3
---	---	---

(F48)

1	2	3	4
5	6	7	8

(F49)

1	2	3	4	5	6	7	8	9	10	11	12	13	14	15
16	17	18	19	20	21	22	23	24	25	26				
27	28	29	30	31										

(F45)

1	2	3	4	5	6	7	8		
9	10	11	12	13	14	15	16	17	18

ABS00264

Diagnostics Procedure with Diagnostic Trouble Code (DTC)

ABS (DIAGNOSTIC)

Step	Check	Yes	No
1 CHECK OUTPUT OF G SENSOR USING SELECT MONITOR. 1) Select "Current data display & Save" on the select monitor. 2) Read G sensor output on the select monitor display.	Is the voltage 2.1 — 2.5 V when G sensor is in horizontal position?	Go to step 2.	Go to step 5.
2 CHECK POOR CONTACT IN CONNECTORS. Turn the ignition switch to OFF.	Is there poor contact in connector between ABSCM&H/U and G sensor?	Repair the connector.	Go to step 3.
3 CHECK ABSCM&H/U. 1) Connect all connectors. 2) Erase the memory. 3) Perform the inspection mode. 4) Read out the DTC.	Is the same DTC as in current diagnosis still being output?	Replace the ABSCM only. <Ref. to ABS-8, ABSCM (ABS CONTROL MODULE), REPLACE, ABS Control Module and Hydraulic Control Unit (ABSCM&H/U).>	Go to step 4.
4 CHECK ANY OTHER DIAGNOSTIC TROUBLE CODES (DTCs) APPEARANCE.	Are other DTCs being output?	Proceed with the diagnosis corresponding to DTC.	A temporary poor contact.
5 CHECK OPEN CIRCUIT IN G SENSOR OUTPUT HARNESS AND GROUND HARNESS. 1) Turn the ignition switch to OFF. 2) Disconnect the connector from ABSCM&H/U. 3) Measure the resistance between ABSCM&H/U connector terminals. <i>Connector & terminal</i> <i>LHD: (B301) No. 6 — No. 28:</i> <i>RHD: (F49) No. 6 — No. 28:</i>	Is the resistance 5.0 — 5.6 kΩ?	Go to step 6.	Repair the harness/connector between G sensor and ABSCM&H/U.
6 CHECK GROUND SHORT OF HARNESS. Measure the resistance between ABSCM&H/U connector and chassis ground. <i>Connector & terminal</i> <i>LHD: (B301) No. 28 — Chassis ground:</i> <i>RHD: (F49) No. 28 — Chassis ground:</i>	Is the resistance more than 1 MΩ?	Go to step 7.	Repair the harness between G sensor and ABSCM&H/U. Replace the ABSCM only. <Ref. to ABS-8, ABSCM (ABS CONTROL MODULE), REPLACE, ABS Control Module and Hydraulic Control Unit (ABSCM&H/U).>
7 CHECK G SENSOR. 1) Remove the console box. 2) Remove the G sensor from vehicle. 3) Connect the connector to G sensor. 4) Connect the connector to ABSCM&H/U. 5) Turn the ignition switch to ON. 6) Measure the voltage between G sensor connector terminals. <i>Connector & terminal</i> <i>(B292) No. 2 (+) — No. 3 (-):</i>	Is the voltage 2.1 — 2.5 V when G sensor is in horizontal position?	Go to step 8.	Replace the G sensor. <Ref. to ABS-23, G Sensor.>

Diagnostics Procedure with Diagnostic Trouble Code (DTC)

ABS (DIAGNOSTIC)

Step	Check	Yes	No
8 CHECK G SENSOR. Measure the voltage between G sensor connector terminals. <i>Connector & terminal</i> <i>(B292) No. 2 (+) — No. 3 (-):</i>	Is the voltage 3.7 — 4.1 V when G sensor is inclined forwards to 90°?	Go to step 9 .	Replace the G sensor. <Ref. to ABS-23, G Sensor.>
9 CHECK G SENSOR. Measure the voltage between G sensor connector terminals. <i>Connector & terminal</i> <i>(B292) No. 2 (+) — No. 3 (-):</i>	Is the voltage 0.5 — 0.9 V when G sensor is inclined backwards to 90°?	Go to step 10 .	Replace the G sensor. <Ref. to ABS-23, G Sensor.>
10 CHECK ABSCM&H/U. 1) Turn the ignition switch to OFF. 2) Connect all connectors. 3) Erase the memory. 4) Perform the inspection mode. 5) Read out the DTC.	Is the same DTC as in current diagnosis still being output?	Replace the ABSCM only. <Ref. to ABS-8, ABSCM (ABS CONTROL MODULE), REPLACE, ABS Control Module and Hydraulic Control Unit (ABSCM&H/U).>	Go to step 11 .
11 CHECK ANY OTHER DIAGNOSTIC TROUBLE CODES (DTCs) APPEARANCE.	Are other DTCs being output?	Proceed with the diagnosis corresponding to DTC.	A temporary poor contact.

Diagnostics Procedure with Diagnostic Trouble Code (DTC)

ABS (DIAGNOSTIC)

AH:DTC 56 DETECTION OF G SENSOR STICK

DIAGNOSIS:

Faulty G sensor output voltage

TROUBLE SYMPTOM:

ABS does not operate.

WIRING DIAGRAM:

- LHD model

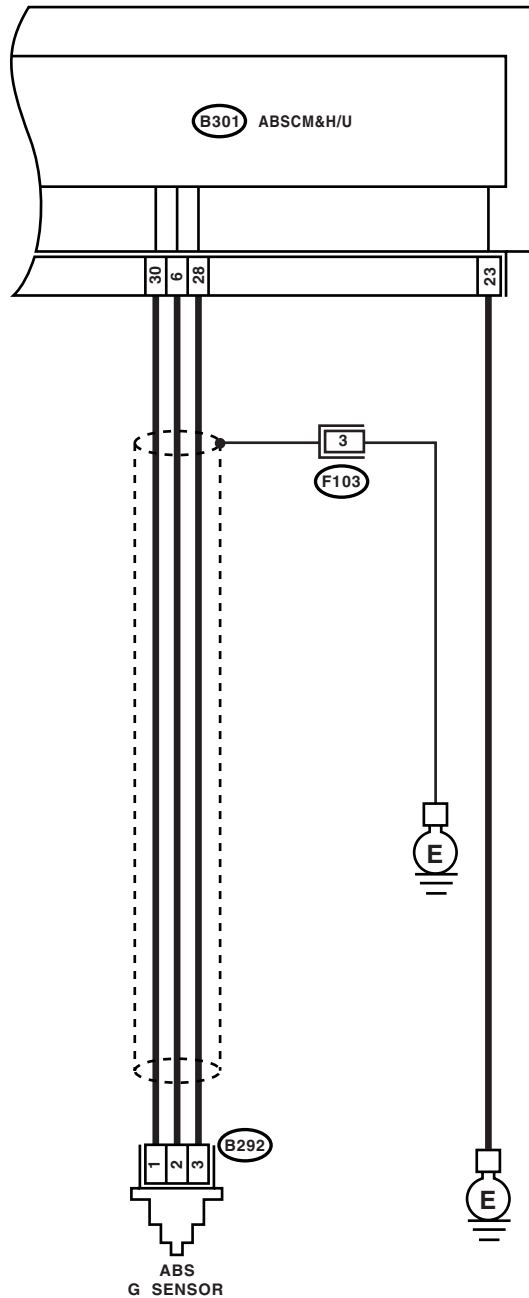

B292

1	2	3
---	---	---

F103

1	2	3	4
5	6	7	8

B301

1	2	3	4	5	6	7	8	9	10	11	12	13	14	15
16	17	18	19	20	21	22	23	24	25	26				
27	28	29	30	31										

ABS00457

Diagnostics Procedure with Diagnostic Trouble Code (DTC)

ABS (DIAGNOSTIC)

- RHD model

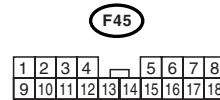
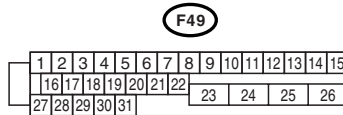
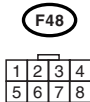
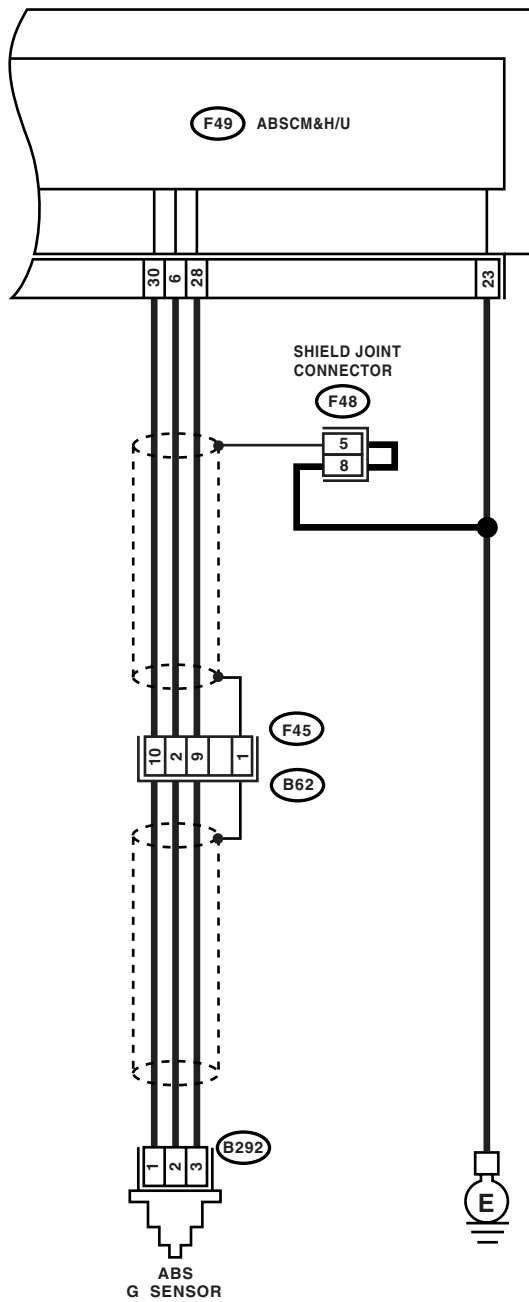

ABS00264

Diagnostics Procedure with Diagnostic Trouble Code (DTC)

ABS (DIAGNOSTIC)

Step	Check	Yes	No	
1	CHECK ALL FOUR WHEELS FOR FREE TURNING.	Have the wheels been turned freely such as when vehicle is lifted up, or operated on a rolling road?	The ABS is normal. Erase the DTC.	Go to step 2.
2	CHECK OUTPUT OF G SENSOR USING SELECT MONITOR. 1) Select "Current data display & Save" on the select monitor. 2) Read the select monitor display.	Is the G sensor output on monitor display 2.1 — 2.5 V when the vehicle is in horizontal position?	Go to step 3.	Go to step 8.
3	CHECK OUTPUT OF G SENSOR USING SELECT MONITOR. 1) Turn the ignition switch to OFF. 2) Remove the console box. 3) Remove the G sensor from vehicle. (Do not disconnect the connector.) 4) Turn the ignition switch to ON. 5) Select "Current data display & Save" on the select monitor. 6) Read the select monitor display.	Is the voltage 3.7 — 4.1 V when G sensor is inclined forwards to 90°?	Go to step 4.	Replace the G sensor. <Ref. to ABS-23, G Sensor.>
4	CHECK OUTPUT OF G SENSOR USING SELECT MONITOR. Read the select monitor display.	Is the voltage 0.5 — 0.9 V when G sensor is inclined backwards to 90°?	Go to step 5.	Replace the G sensor. <Ref. to ABS-23, G Sensor.>
5	CHECK POOR CONTACT IN CONNECTORS. Turn the ignition switch to OFF.	Is there poor contact in connector between ABSCM&H/U and G sensor?	Repair the connector.	Go to step 6.
6	CHECK ABSCM&H/U. 1) Connect all connectors. 2) Erase the memory. 3) Perform the inspection mode. 4) Read out the DTC.	Is the same DTC as in current diagnosis still being output?	Replace the ABSCM only. <Ref. to ABS-8, ABSCM (ABS CONTROL MODULE), REPLACE, ABS Control Module and Hydraulic Control Unit (ABSCM&H/U).>	Go to step 7.
7	CHECK ANY OTHER DIAGNOSTIC TROUBLE CODES (DTCs) APPEARANCE.	Are other DTCs being output?	Proceed with the diagnosis corresponding to DTC.	A temporary poor contact.
8	CHECK OPEN CIRCUIT IN G SENSOR OUTPUT HARNESS AND GROUND HARNESS. 1) Turn the ignition switch to OFF. 2) Disconnect the connector from ABSCM&H/U. 3) Measure the resistance between ABSCM&H/U connector terminals. Connector & terminal LHD: (B301) No. 6 — No. 28: RHD: (F49) No. 6 — No. 28:	Is the resistance 5.0 — 5.6 kΩ?	Go to step 9.	Repair the harness connector between G sensor and ABSCM&H/U.
9	CHECK G SENSOR. 1) Remove the console box. 2) Remove the G sensor from vehicle. 3) Connect the connector to G sensor. 4) Connect the connector to ABSCM&H/U. 5) Turn the ignition switch to ON. 6) Measure the voltage between G sensor connector terminals. Connector & terminal (B292) No. 2 (+) — No. 3 (-):	Is the voltage 2.1 — 2.5 V when G sensor is in horizontal position?	Go to step 10.	Replace the G sensor. <Ref. to ABS-23, G Sensor.>

Diagnostics Procedure with Diagnostic Trouble Code (DTC)

ABS (DIAGNOSTIC)

Step	Check	Yes	No
10 CHECK G SENSOR. Measure the voltage between G sensor connector terminals. <i>Connector & terminal</i> <i>(B292) No. 2 (+) — No. 3 (-):</i>	Is the voltage 3.7 — 4.1 V when G sensor is inclined forwards to 90°?	Go to step 11.	Replace the G sensor. <Ref. to ABS-23, G Sensor.>
11 CHECK G SENSOR. Measure the voltage between G sensor connector terminals. <i>Connector & terminal</i> <i>(B292) No. 2 (+) — No. 3 (-):</i>	Is the voltage 0.5 — 0.9 V when G sensor is inclined to backwards to 90°?	Go to step 12.	Replace the G sensor. <Ref. to ABS-23, G Sensor.>
12 CHECK ABSCM&H/U. 1) Turn the ignition switch to OFF. 2) Connect all connectors. 3) Erase the memory. 4) Perform the inspection mode. 5) Read out the DTC.	Is the same DTC as in current diagnosis still being output?	Replace the ABSCM only. <Ref. to ABS-8, ABSCM (ABS CONTROL MODULE), REPLACE, ABS Control Module and Hydraulic Control Unit (ABSCM&H/U).>	Go to step 13.
13 CHECK ANY OTHER DIAGNOSTIC TROUBLE CODES (DTCs) APPEARANCE.	Are other DTCs being output?	Proceed with the diagnosis corresponding to DTC.	A temporary poor contact.

General Diagnostics Table

ABS (DIAGNOSTIC)

14. General Diagnostics Table

A: INSPECTION

Symptom		Probable faulty units/parts
Vehicle instability during braking	Vehicle pulls to either side.	<ul style="list-style-type: none"> • ABSCM&H/U (solenoid valve) • ABS wheel speed sensor • Brake (caliper & piston, pads) • Wheel alignment • Tire specifications, tire wear and air pressures • Incorrect wiring or piping connections • Road surface (uneven, camber)
	Vehicle spins.	<ul style="list-style-type: none"> • ABSCM&H/U (solenoid valve) • ABS wheel speed sensor • Brake (pads) • Tire specifications, tire wear and air pressures • Incorrect wiring or piping connections
Poor braking	Long braking/stopping distance	<ul style="list-style-type: none"> • ABSCM&H/U (solenoid valve) • Brake (pads) • Air in brake line • Tire specifications, tire wear and air pressures • Incorrect wiring or piping connections
	Wheel locks.	<ul style="list-style-type: none"> • ABSCM&H/U (solenoid valve, motor) • ABS wheel speed sensor • Incorrect wiring or piping connections
	Brake dragging	<ul style="list-style-type: none"> • ABSCM&H/U (solenoid valve) • ABS wheel speed sensor • Master cylinder • Brake (caliper & piston) • Parking brake • Axle & wheels • Brake pedal play
	Long brake pedal stroke	<ul style="list-style-type: none"> • Air in brake line • Brake pedal play
	Vehicle pitching	<ul style="list-style-type: none"> • Suspension play or fatigue (reduced damping) • Incorrect wiring or piping connections • Road surface (uneven)
	Unstable or uneven braking	<ul style="list-style-type: none"> • ABSCM&H/U (solenoid valve) • ABS wheel speed sensor • Brake (caliper & piston, pads) • Tire specifications, tire wear and air pressures • Incorrect wiring or piping connections • Road surface (uneven)
	Excessive pedal vibration	<ul style="list-style-type: none"> • Incorrect wiring or piping connections • Road surface (uneven)
Vibration and/or noise (while driving on slippery roads)	Noise from ABSCM&H/U	<ul style="list-style-type: none"> • ABSCM&H/U (mount bushing) • ABS wheel speed sensor • Brake piping
	Noise from front of vehicle	<ul style="list-style-type: none"> • ABSCM&H/U (mount bushing) • ABS wheel speed sensor • Master cylinder • Brake (caliper & piston, pads, rotor) • Brake piping • Brake booster & check valve • Suspension play or fatigue
	Noise from rear of vehicle	<ul style="list-style-type: none"> • ABS wheel speed sensor • Brake (caliper & piston, pads, rotor) • Parking brake • Brake piping • Suspension play or fatigue